

BEER & BEVERAGE COOLING & DISPENSING EQUIPMENT

FROM TANK TO TAP & EVERYTHING IN BETWEEN

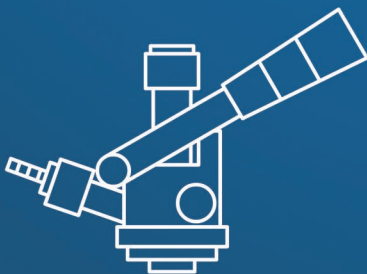
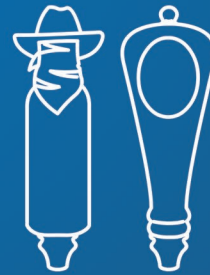
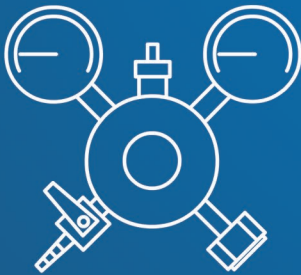
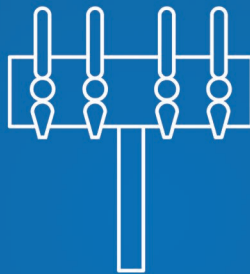
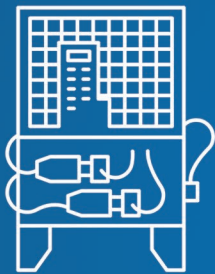

CUSTOM TOWERS

IF YOU CAN IMAGINE IT. WE CAN BUILD IT.

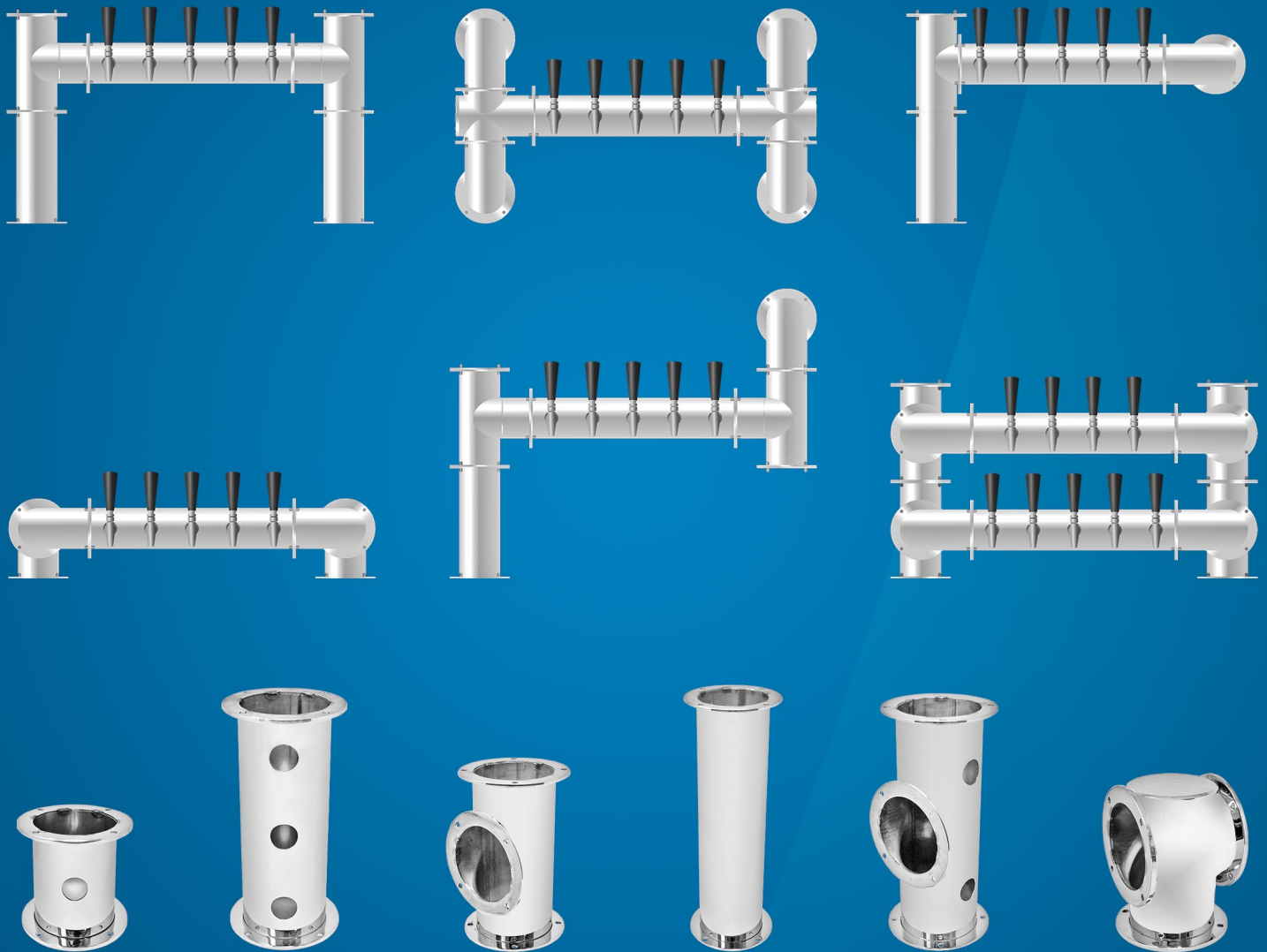

CUSTOMIZED & ASSEMBLED IN CANADA



ALL TOWER PARTS ARE MADE FROM 304 STAINLESS STEEL

More information & specifications available on page 51

**ANY SIZE.
ANY COLOUR.
WE CAN MAKE IT.**

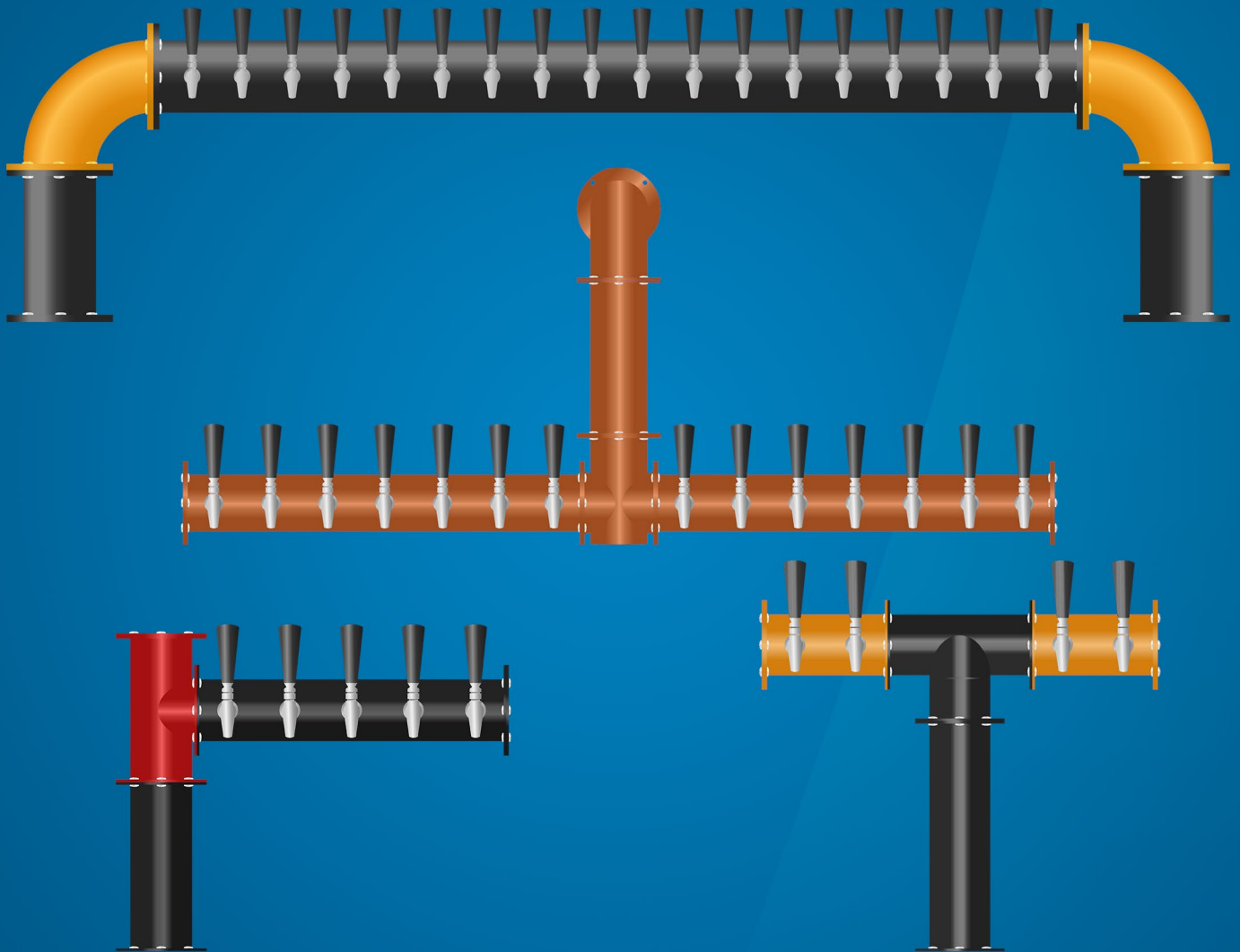

CUSTOM COLOUR FINISHES AND BRANDING AVAILABLE



AVAILABLE IN BOTH AIR AND GLYCOL COOLED VERSIONS



SIMPLIFIED PRICING RATE FOR COLOUR OPTIONS

SCHÄFER TANKS



- Available in 500L, 800L and 1000L sizes
- Jacketed option (for fermentation and aging, anything needing temperature control)
- Non-jacketed option (for product and ingredient storage)
- Aseptic tanks can be steam sterilized to be 100% germ free
- Forklift channels for easy mobility
- Tri-connect total drain system for product transfer and cleaning



STAINLESS STEEL EXTRA 1.5 HP GLYCOL CHILLER

- Stainless steel housing for brewery usage.
- 10800 BTU's for chilling up to 20bbl systems.
- Unit comes with 2 pumps & 2 more can be added for a total of 4.
- Dumper coupling assemblies included for additional safety to prevent damage to the pump(s)



SCHÄFER



SCHAEFER STAINLESS STEEL KEGS

- European-made beer kegs
- 304 Stainless Steel
- All kegs are manufactured with stackable chimes
- Sanke D-type colour-coded MicroMatic or DSI spears
- 2D Barcode to identify kegs
- All kegs are professionally passivated & pickled
- **Super-fast shipping & in-house branding performed at two facilities on the East and West coast!**

More information & specifications available on page 136

SCHÄFER



SCHAEFER ECO + PLUS KEGS

- European-made beer kegs
- 2D Barcode to identify kegs
- Eco Kegs - Up to 30% lighter than regular kegs
- Plus Kegs - Super durable and robust designs
- Available with custom branding
- Safety discs installed on all kegs for added safety
- Specially designed comfort grips to reduce strain on your hands

More information & specifications available on page **137**



SPUTNIK 1/4HP & 1/6HP

- RAPIDLY COOL DRAUGHT BEER - NO ICE NEEDED!

- Upgrade your jockey box to UBC Sputnik, an instant dry cooling & dispensing unit for delivering chilled beer & cider at your preferred temperature.

- Dry Cooling Dispensers such as the UBC Sputnik offer instant cooling wrapped up in an easy to use package that's perfect for beer festivals, small bars or brewery tasting rooms.

- Available Unit Capacities:
1/4HP = 60 L/hr & 1/6HP = 20 L/hr

More information & specifications available on page 71

CUSTOM POS PRODUCTS



- Choose from a wide range of products including, pub signs, furniture, chalk boards and much more!
- Made in Europe from high quality materials to stand the test of time
- Quickly increase your brand's reputation
- Professionally designed & manufactured by UBC Group



UBC UMBRELLAS

**NOW AVAILABLE
IN DIFFERENT SIZES &
STYLES!**

- Buy directly from the manufacturer
- Available in either round or square styling
- Delivered faster than most other customized market umbrellas
- Made in Europe by UBC PROMO

More information & specifications available on page **140-145**

DRAUGHT BEER TRAINING SEMINARS

GET HANDS ON EXPERIENCE FROM INDUSTRY
VETERANS AND BECOME A PROFESSIONAL YOURSELF

BECOME AN EXPERT ON

- DRAUGHT BEER SYSTEMS
- TROUBLESHOOTING BEER ISSUES
- BEER EQUIPMENT
- BEER GAS

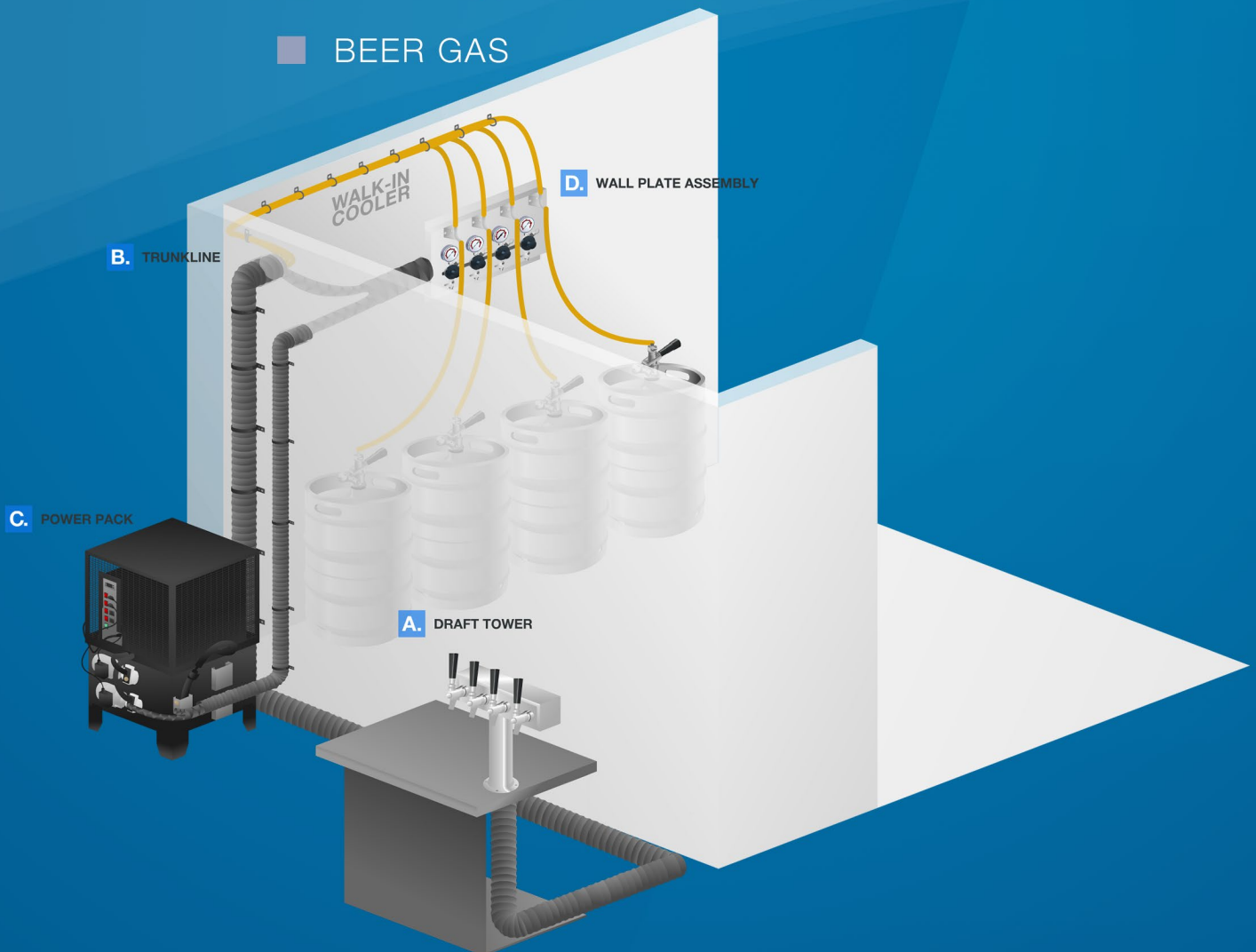



STAINLESS STEEL TOWERS

- **Gefest Towers** 18
- **Vice Towers** 19
- **Indie & LUMINA Towers** 20
- **Persey Towers** 21
- **JG Towers** 23
- **Arcadia Towers** 24
- **Terra Towers** 28
- **Large Diameter Towers** 32
- **Yukon Towers** 34



AMERICAN STYLE TOWERS

- **Cylinder Towers** 38
- **Tee Box Towers** 39
- **Double Pedestal Towers** 40
- **Wall Mount & Under Bar Dispensers** ... 41
- **Wall Mount Growler Drip Tray** 42



EUROPEAN AND ICE TOWERS

- **Milano Towers** 44
- **Venus & Brew Kettle Towers** 46
- **TOF / Arcadia ICE Towers** 47



CERAMIC TOWERS

- **Ceramic Towers** 49

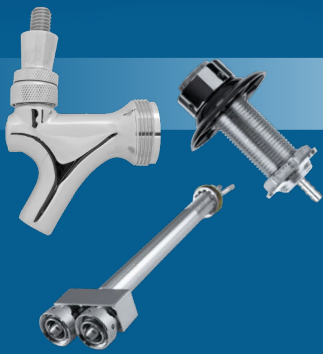

FAUCETS AND SHANKS

- **Tower Customization Parts** 51
- **Domestic Faucets** 53
- **Domestic Faucets Parts** 54
- **Stout & Euro Faucets** 55
- **Shanks & Parts** 56

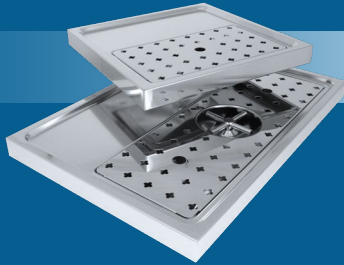

DRIP TRAYS

- **Countertop Drip Trays**..... 59
- **Platform Drip Trays**..... 60
- **Drip Tray Wall Mount & Drip Tray Parts** 61
- **Clamp-on Drip Trays**..... 62
- **Glass Rinser Drip Trays**..... 62



GLYCOL POWER PACKS

- **Glycol Power Packs** 64



DRAUGHT BEER ICE BANK FLASH COOLERS

- **Flash Coolers**..... 71

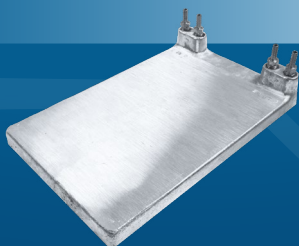

BEVERAGE COOLING & DISPENSING

- **Counter Electric Post-Mix Dispensers** ... 71
- **Ice Cooled Drop-in Post-Mix Dispensers** ... 75
- **Epoque** 77
- **Beverage and Carbonator Coolers** 78
- **Beverage System Parts** 79



WINE-ON-TAP SYSTEMS

- Wine-on-Tap 82



DRAUGHT BEER DISPENSE SYSTEM COMPONENTS



- Primary Regulators 84
- Secondary Regulators 85
- Regulator Parts 86
- Gas Blenders 88
- Regulator Panels 89
- Pumps & Motors 91
- Kegs 92
- Keg Accessories 93
- Keg Couplers & Parts 94
- Draught Beer System Parts 97
- John Guest Fittings 98
- Fittings 101
- Trunkline and Tubing 103



KEGERATORS

- Kegmaster 2 107
- Kegmaster Eco 108
- Kegmaster Craft 109
- KegBar BB-100 110
- Large Kegerators 111
- Kegerator Accessories 112



REACH-IN REFRIGERATORS

- Display Cooler 114
- Virgo Slim Refrigerator 115
- Smart Cool 350 116
- IceStream OPTIMA 117
- IceStream SUPER LARGE 118



BACK BAR COOLERS

- **CoolBar BB-100** 120
- **Large Back Bar Coolers** 121



MOBILE AND EVENT BEER COOLING & DISPENSING

- **Mobile Dispense Parts** 124
- **Jockey Box Picnic Coolers** 125
- **Jockey Box Tapping Kits** 127



INSTALLATION AND MAINTENANCE TOOLS

- **Tools & Accessories** 130
- **Beer Line Cleaning Equipment** 131



BREWERY TARGETED PRODUCTS

- **Schafer Kegs** 135
- **Schafer Tanks** 138
- **Branded Towers & Medallions** 139
- **PEGAS CrafTap 3.0** 140
- **PEGAS CrafPad Lite** 141
- **Growler Filling Station** 142
- **Ceramic Tap Handles** 144
- **Illuminated Pub Signs** 145
- **Branded Jockey Boxes** 146
- **Patio Umbrellas / Chalkboards** 147
- **Tables** 149

WARRANTY AND RETURN POLICY & INDEX

- **Warranty and Return Policy** 150

STAINLESS STEEL TOWERS

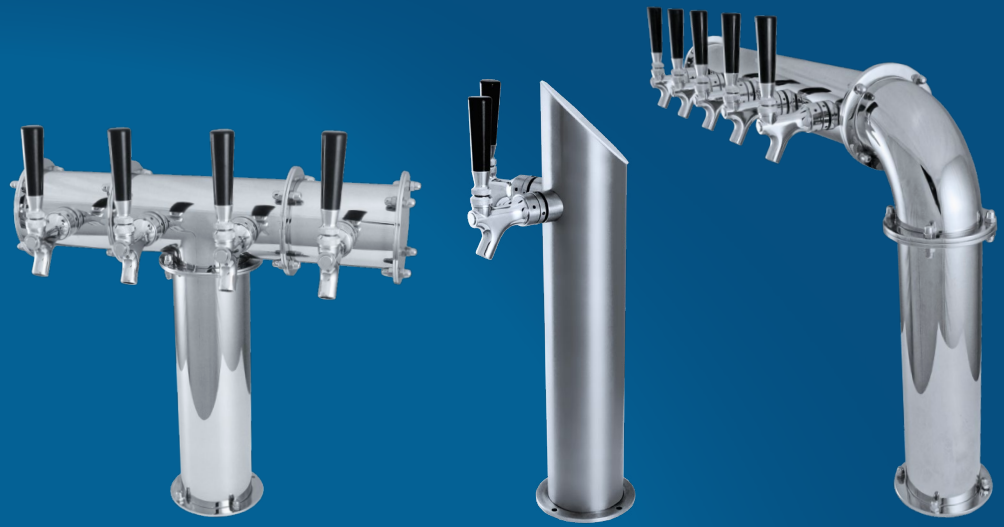

Stainless Steel Towers

- High Quality Polished Stainless Steel
- Chrome, Gold, Copper and custom finishing available
- Optional branded LED and non-LED medallions

■ Gefest Towers	18
■ Vice Towers	19
■ Indie & LUMINA Towers	20
■ Persey Towers	21
■ JG Towers	23
■ Arcadia Towers	24
■ Terra Towers	28
■ Large Diameter Towers	32
■ Yukon Towers	34

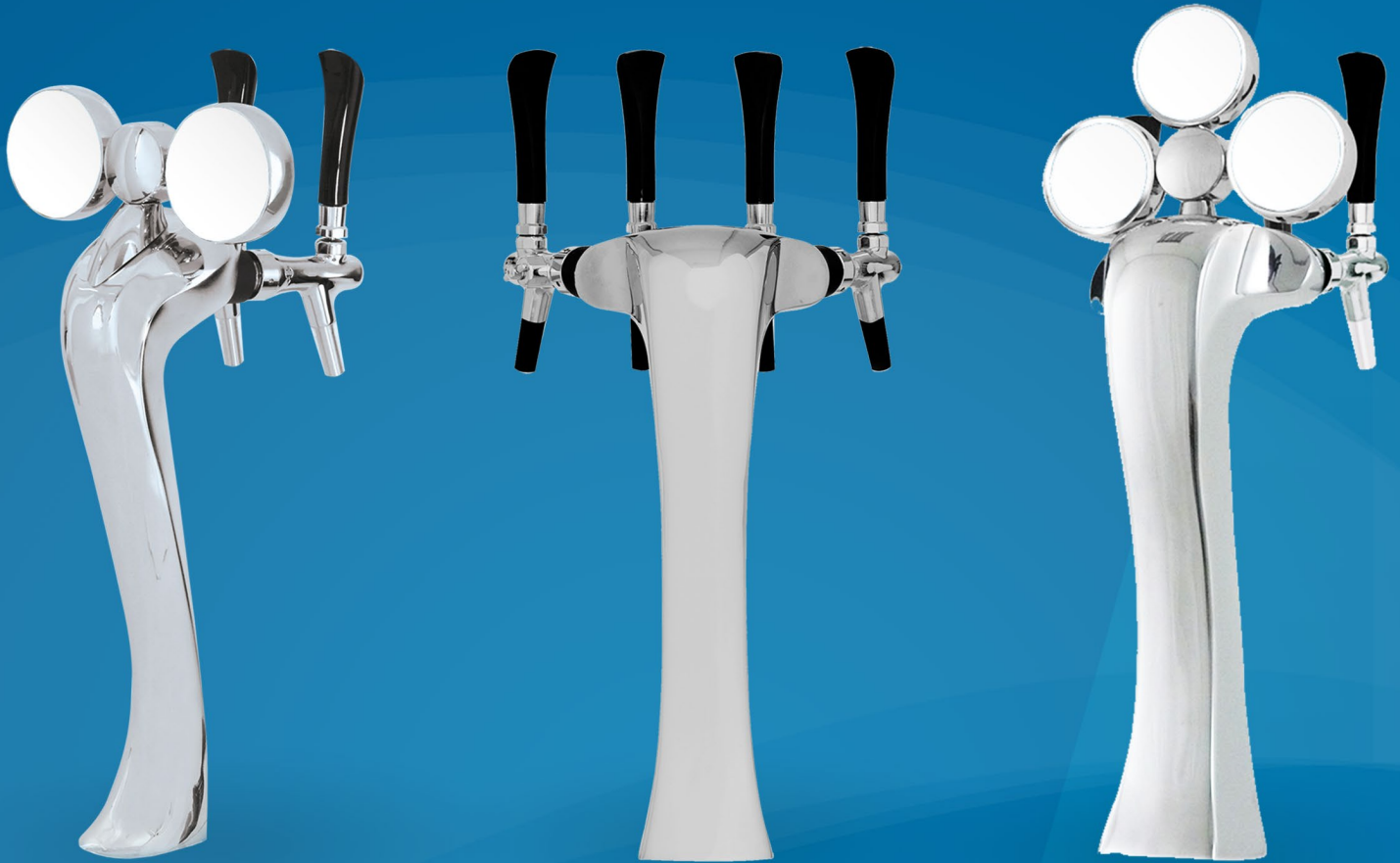

VINSERVICE TOWERS ARE NOW AVAILABLE FROM UBC GROUP CANADA

- Unique design that makes it stand out from the crowd
- Efficiently dispenses up to four different products
- Chrome plated brass body with integrated mounting hardware
- Available in 2, 3, & 4 faucet configurations
- High quality shanks for superior dispensing
- Available with optional LED medallions



STAINLESS STEEL TOWERS GEFEST



- 304 Stainless Steel body
- Product Lines are 3/16" I.D and available in Vinyl or Stainless Steel
- Glycol Lines are Copper, 3/8" O.D.
- Cold blocks to prevent foaming during first pour
- Triple-layer moisture and thermal insulation of glycol and product lines

GEFEST **F**



18 3/8"

12"

3 3/16"

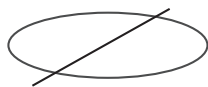

Gefest

Name	SKU	F aucets
Gefest 1, Air	GFA152-1	1
Gefest 1, Glycol	GFG152-1	1
Gefest 2, Air	GFA152-2	2
Gefest 2, Glycol	GFG152-2	2



Available Finishing

Towers on this page are available in several different finishes. A swatch can be seen on page 3. Contact your Sales Manager for further information.

Recommended Drip Trays

Tower	Drip Tray	Length	Width	Rinser
Gefest 1/2	DTU10x5SS	10"	5"	NO
Gefest 1/2	DTU10x5SS-ND	10"	5"	NO
Gefest 1/2	DTU12x7SS	12"	7"	NO
Gefest 1/2	DTF16	16"	15 3/4"	YES
Gefest 1/2	DTF16R	16"	15 3/4"	YES



DTU10x5SS-ND



DTF16R



STAINLESS STEEL TOWERS

VICE

- 304 Stainless Steel body
- Product Lines are 3/16" I.D and available in Vinyl or Stainless Steel
- Glycol Lines are Copper, 3/8" O.D.
- Cold blocks to prevent foaming during first pour
- Triple-layer moisture and thermal insulation of glycol and product lines



Vice Tower

Name	SKU	F aucets	W idth
Vice, 3 Tap	VCE3	3	16 1/2"
Vice, 4 Tap	VCE4	4	18 1/2"
Vice, 5 Tap	VCE5	5	22 1/2"



Available Finishing

Towers on this page are available in several different finishes. A swatch can be seen on page 3. Contact your Sales Manager for further information.

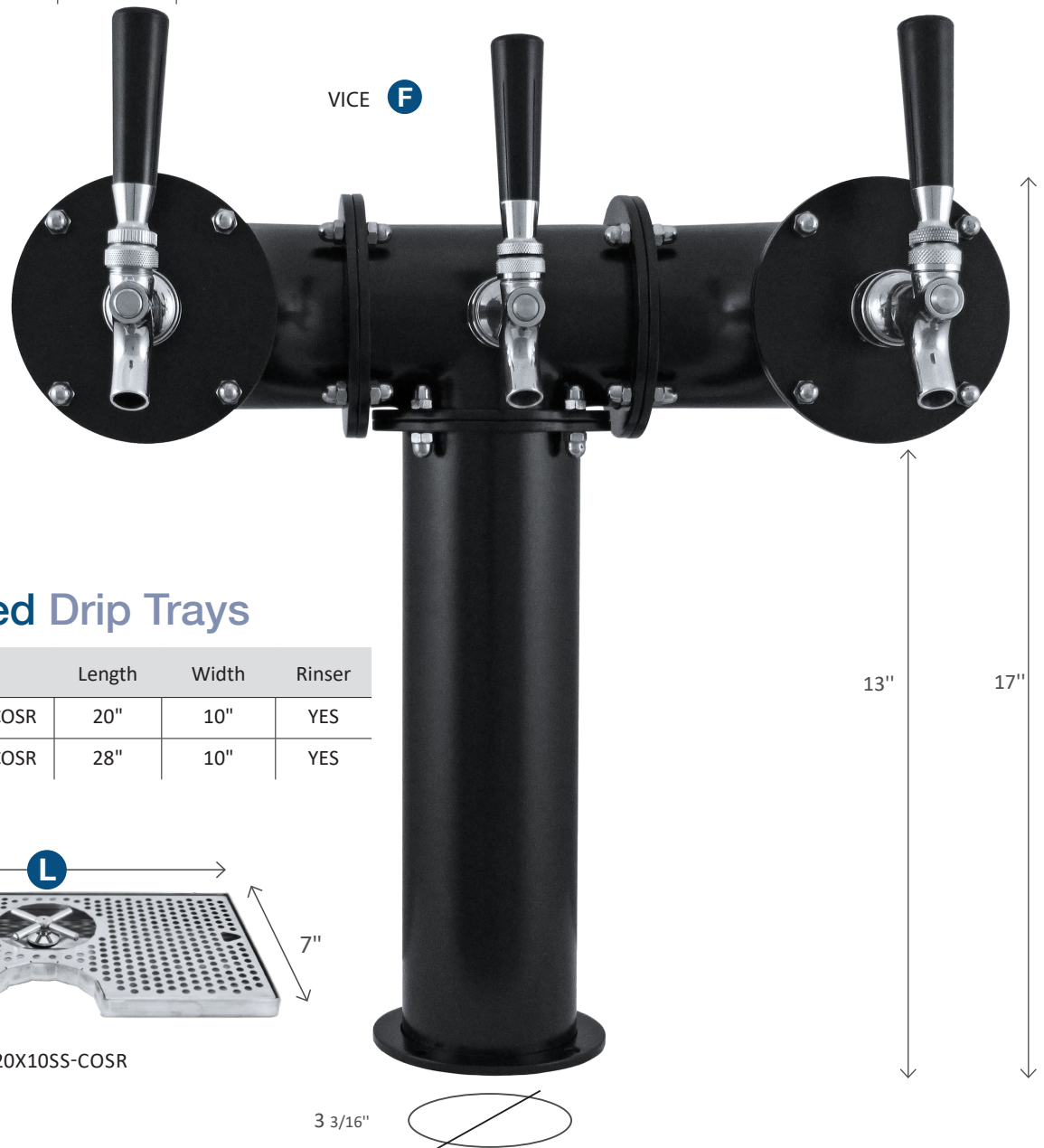

Recommended Drip Trays

Tower	Drip Tray	Length	Width	Rinser
Vice, 3 / 4	DTU20x10SS-COSR	20"	10"	YES
Vice, 5	DTU28x10SS-COSR	28"	10"	YES

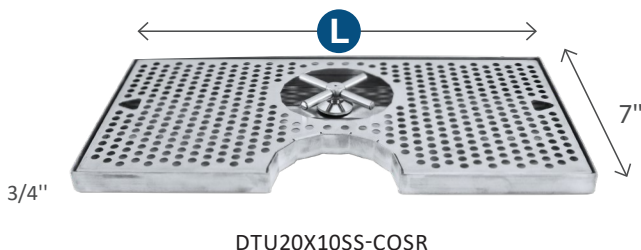

3 3/16"

STAINLESS STEEL TOWERS

INDIE & LUMINA

- 304 Stainless Steel body
- Product Lines are 3/16" I.D and available in Vinyl or Stainless Steel
- Glycol Lines are Copper, 3/8" O.D.
- Cold blocks to prevent foaming during first pour
- Triple-layer moisture and thermal insulation of glycol and product lines



Indie Towers

Name	SKU	Faucets
Indie 1, Air	IND1	1
Indie 1, Glycol	IND1G	1

Lumina LED

Name	SKU	Faucets
Lumina 1, LED, Glycol	LMN152-1	1



Available Finishing

Towers on this page are available in several different finishes. A swatch can be seen on page 3. Contact your Sales Manager for further information.

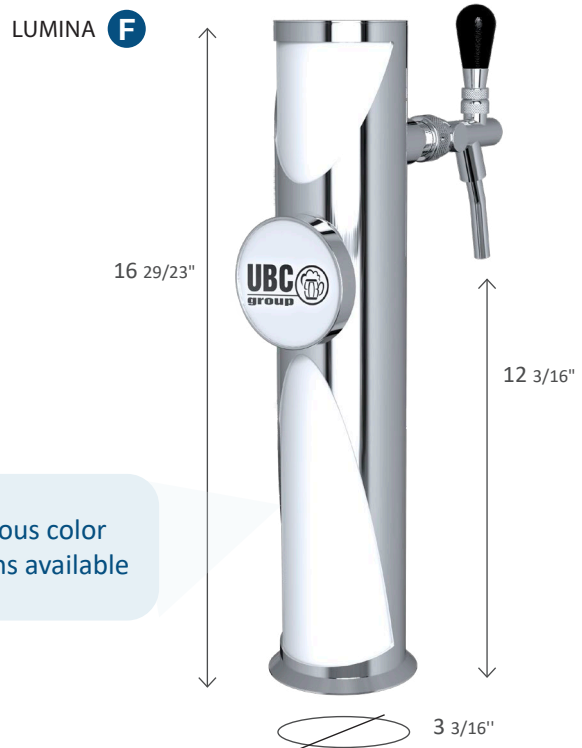

Various color options available



STAINLESS STEEL TOWERS

PERSEY



- 304 Stainless Steel body
- Product Lines are 3/16" I.D and available in Vinyl or Stainless Steel
- Glycol Lines are Copper, 3/8" O.D.
- Cold blocks to prevent foaming during first pour
- Triple-layer moisture and thermal insulation of glycol and product lines



Left or Right arm configuration is determined by 'Bartender View'.

Viewing the tower from the faucet side, the leg side determines the configuration (left / right)

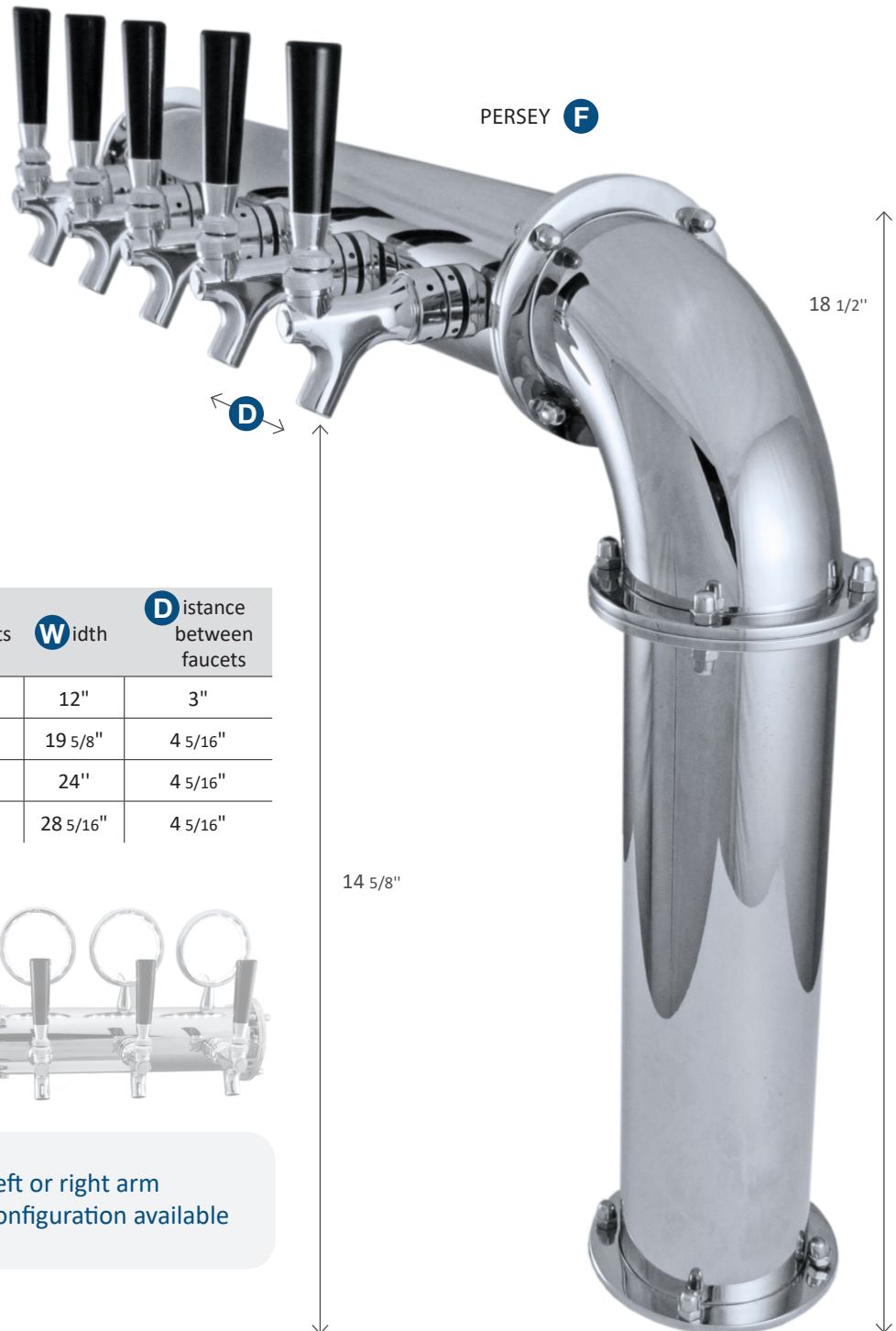

PERSEY **F**

Persey Towers

Name	SKU	F aucets	W idth	D istance between faucets
Persey 2	PS189-2 (L/R)	2	12"	3"
Persey 3	PS189-3 (L/R)	3	19 5/8"	4 5/16"
Persey 4	PS190-4 (L/R)	4	24"	4 5/16"
Persey 5	PS192-5 (L/R)	5	28 5/16"	4 5/16"



Custom branding and Top LED medallions also available

Left or right arm configuration available

3 3/16"



STAINLESS STEEL TOWERS

PERSEY SHORT LEG



- 304 Stainless Steel body
- Product Lines are 3/16" I.D and available in Vinyl or Stainless Steel
- Glycol Lines are Copper, 3/8" O.D.
- Cold blocks to prevent foaming during first pour
- Triple-layer moisture and thermal insulation of glycol and product lines

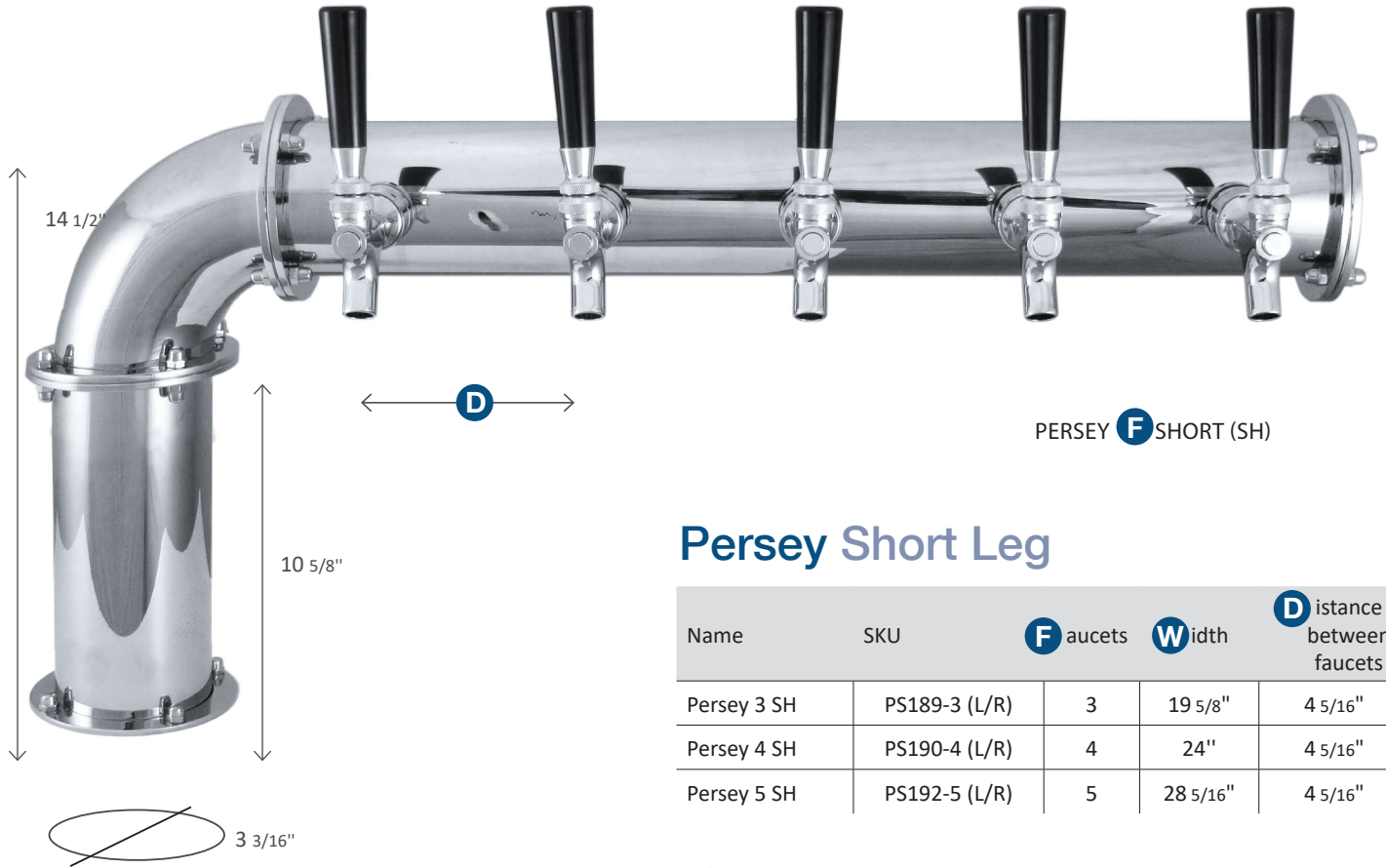

PERSEY **F** SHORT (SH)

Persey Short Leg

Name	SKU	F aucets	W idth	D istance between faucets
Persey 3 SH	PS189-3 (L/R)	3	19 5/8"	4 5/16"
Persey 4 SH	PS190-4 (L/R)	4	24"	4 5/16"
Persey 5 SH	PS192-5 (L/R)	5	28 5/16"	4 5/16"



Available Finishing

Towers on this page are available in several different finishes. A swatch can be seen on page 3. Contact your Sales Manager for further information.

Recommended Drip Trays

Tower	Drip Tray	Length	Width	Rinser
Persey 2	DTU10x5SS	10"	5 1/2"	NO
Persey 3	DTU15x5SS	15"	5 1/2"	NO
Persey 4	DTU20x7SS	20"	7"	YES
Persey 5	DTU24x7SS	24"	7"	YES

STAINLESS STEEL TOWERS

JG

- 304 Stainless Steel body
- Product Lines are 3/16" I.D and available in Vinyl or Stainless Steel
- Glycol Lines are Copper, 3/8" O.D.
- Cold blocks to prevent foaming during first pour
- Triple-layer moisture and thermal insulation of glycol and product lines



JG Tower

Name	SKU	F aucets	W idth	D istance between faucets
JG Tower 3	JG190-3	3	19 5/8"	4 5/16"
JG Tower 4	JG190-4	4	24"	4 5/16"
JG Tower 6	JG190-7	6	38 3/16"	4 5/16"
JG Tower 8	JG190-8	8	35 1/2"	3"
JG Tower 10	JG190-10	10	41 5/8"	3"
JG Tower 12	JG190-12	12	47 5/8"	3"



Recommended Drip Trays

Tower	Drip Tray	Length	Width
JG Tower 3	DTU12X7SS	12"	7"
JG Tower 4	DTU16X8SS	16"	7"
JG Tower 6	DTU24X7SS	24"	7"
JG Tower 8	DTU24X7SS	24"	7"
JG Tower 10	DTU36X7SS	36"	7"
JG Tower 12	DTU45X7SS	45"	7"



Available Finishing

Towers are available in several different finishes
 A swatch can be seen on page 3.
 Contact your Sales Manager for further information



STAINLESS STEEL TOWERS

ARCADIA

- 304 Stainless Steel body
- Product Lines are 3/16" I.D and available in Vinyl or Stainless Steel
- Glycol Lines are Copper, 3/8" O.D.



Arcadia

Name	SKU	Faucets	Width	Distance between faucets
Arcadia 6	AC191-6	6	37 3/4"	4 5/16"
Arcadia 8	AC228-8	8	36 1/5"	3"
Arcadia 8 LED	AC228-8L	8	46 11/16"	4 5/16"
Arcadia 10	AC246-10	10	41 5/8"	3"
Arcadia 10 LED	AC246-10L	10	55 5/16"	4 5/16"
Arcadia 12	AC262-12	12	47 5/8"	3"
Arcadia 12 LED	AC262-12L	12	64 5/16"	4 5/16"
Arcadia 14	AC272-14	14	53 1/2"	3"
Arcadia 16	AC282-16	16	66 3/4"	3"
Arcadia 18	AC282-18	18	72 3/4"	3"
Arcadia 20	AC282-20	20	78 2/3"	3"
Arcadia 24	AC282-24	24	90 3/5"	3"



Available Finishing

Towers on this page are available in several different finishes
 A swatch can be seen on page 3.
 Contact your Sales Manager for further information

STAINLESS STEEL TOWERS

ARCADIA

- Cold blocks to prevent foaming during first pour
- Triple-layer moisture and thermal insulation of glycol and product lines



15 7/8"



Stainless Steel product lines
FOR BEER OR WINE



D

Arcadia Short Leg

* Leg size on Short Leg Arcadia towers are 8"

Name	SKU	Faucets	Width	Distance between faucets
Arcadia 6 Short	AC191-6SH	6	37 3/4"	4 5/16"
Arcadia 8 Short	AC228-8SH	8	36 1/5"	3"
Arcadia 10 Short	AC246-10SH	10	41 5/8"	3"
Arcadia 12 Short	AC262-12SH	12	47 5/8"	3"
Arcadia 14 Short	AC272-14SH	14	53 1/2"	3"

10 5/8"



ARCADIA **F** SHORT (SH)

3 3/16"

STAINLESS STEEL TOWERS

STAINLESS STEEL TOWERS

ARCADIA TOP LED & FRONT

- 304 Stainless Steel body
- Product Lines are 3/16" I.D and available in Vinyl or Stainless Steel
- Glycol Lines are Copper, 3/8" O.D.
- Cold blocks to prevent foaming during first pour
- Triple-layer moisture and thermal insulation of glycol and product lines



Available Finishing

Towers on this page are available in several different finishes. A swatch can be seen on page 3. Contact your Sales Manager for further information.

Arcadia Top LED

Name	SKU	F aucets	W idth	D istance between faucets
Arcadia 6, Top LED	AC191-6LED	6	37 11/16"	4 11/32"
Arcadia 8, Top LED	AC228-8LED	8	46 5/16"	4 11/32"
Arcadia 10, Top LED	AC246-10LED	10	55"	4 11/32"
Arcadia 12, Top LED	AC262-12LED	12	63 11/16"	4 11/32"
Arcadia 14, Top LED	AC272-14LED	14	72 7/16"	4 11/32"

Arcadia Top LED & Front

Name	SKU	F aucets	W idth	D istance between faucets
Arcadia 5, Top and Front LED	AC205-5FTLED	5	34 5/8"	4 11/32"



Recommended Drip Trays

Tower	Drip Tray	Length	Width
Arcadia 5, Top LED	DTU30x7SS	30"	7"
Arcadia 6, Top LED			
Arcadia 8, Top LED	DTU40x7SS	40"	7"
Arcadia 10, Top LED	DTU48x7SS	48"	7"
Arcadia 12, Top LED	DTU54x7SS	54"	7"
Arcadia 14, Top LED	2 x DTU30x7SS	60" (2 x 30")	7"

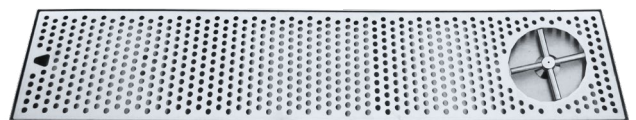

DTU36x7SSR



STAINLESS STEEL TOWERS

ARCADIA NF (No Flanges)



- 304 Stainless Steel body
- 3/8" Copper Glycol recirculation lines
- Cold blocks to prevent foaming during first pour
- Triple-layer moisture and thermal insulation of glycol and product lines



Arcadia NF

Name	SKU	Faucets	Width	Distance between faucets
Arcadia 6 NF	AC191-6NF	6	37 1/2"	4 1/4"
Arcadia 8 NF	AC228-8NF	8	36 1/4"	3"
Arcadia 10 NF	AC246-10NF	10	42 1/2"	3"
Arcadia 12 NF	AC262-12NF	12	48 1/2"	3"



Recommended Drip Trays

Tower	Drip Tray	Length	Width
Arcadia 6	DTU24X7SS	24"	7"
Arcadia 8	DTU30X7SS	30"	7"
Arcadia 10	DTU30X7SS	30"	7"
Arcadia 12	DTU40X7SS	40"	7"
Arcadia 14	DTU54X7SS	54"	7"



Available Finishing

Towers on this page are available in several different finishes. A swatch can be seen on page 3. Contact your Sales Manager for further information.



STAINLESS STEEL TOWERS TERRA



- 304 Stainless Steel body
- Product Lines are 3/16" I.D and available in Vinyl or Stainless Steel
- Glycol Lines are Copper, 3/8" O.D.
- Cold blocks to prevent foaming during first pour
- Triple-layer moisture and thermal insulation of glycol and product lines

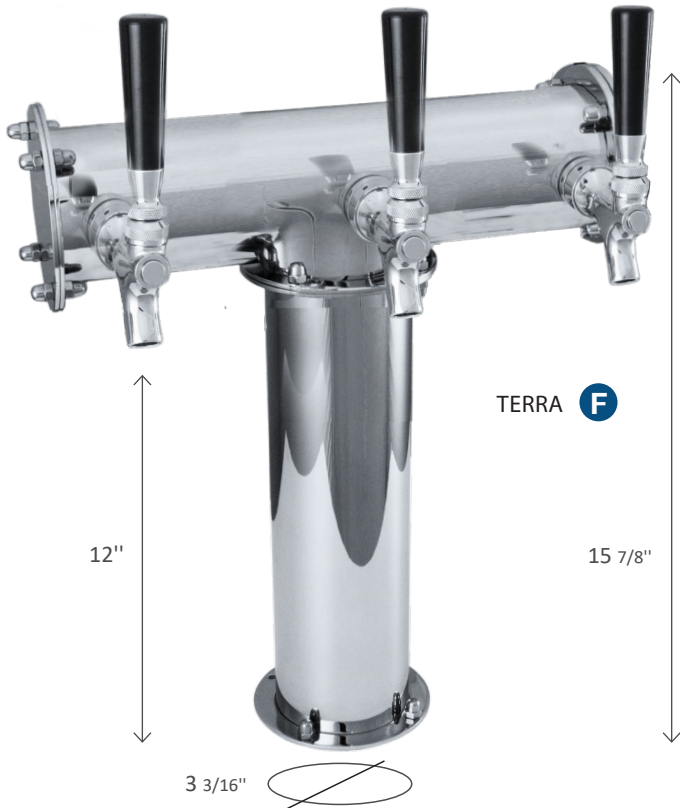

Terra

Name	SKU	F aucets	W idth	D istance between faucets
Terra 2	TR188-2	2	9 7/8"	5 1/8"
Terra 3	TR224-3	3	15 7/8"	5 1/8"
Terra 4	TR230-4	4	17 1/4"	3 7/8"
Terra 5	TR211-5	5	26 7/8"	5 1/8"
Terra 6	TR263-6	6	25"	3 7/8"
Terra 8	TR270-8	8	32"	3 7/8"

Terra Short Leg

Name	SKU	F aucets	W idth	D istance between faucets
Terra 2 SH	TR188-2	2	15 7/8"	5 1/8"
Terra 3 SH	TR224-3	3	15 7/8"	5 1/8"
Terra 4 SH	TR230-4	4	17 1/4"	3 7/8"
Terra 5 SH	TR211-5	5	26 7/8"	5 1/8"
Terra 6 SH	TR263-6	6	25"	3 7/8"
Terra 8 SH	TR270-8	8	32"	3 7/8"



Stainless Steel product lines
FOR BEER OR WINE



Available Finishing

Towers are available in several different finishes
A swatch can be seen on page 3.
Contact your Sales Manager for further information

STAINLESS STEEL TOWERS

TERRA TOP LED & NF



- 304 Stainless Steel body
- Product Lines are 3/16" I.D and available in Vinyl or Stainless Steel
- Glycol Lines are Copper, 3/8" O.D.
- Cold blocks to prevent foaming during first pour
- Triple-layer moisture and thermal insulation of glycol and product lines



Terra NF Top LED

Name	SKU	Faucets	Width	Distance between faucets
Terra 2 NF, TLED	TR188-2NF-TLED	2	9 7/8"	5 1/8"
Terra 3 NF, TLED	TR224-3NF-TLED	3	15 7/8"	5 1/8"
Terra 4 NF, TLED	TR230-4NF-TLED	4	18 1/8"	3 7/8"
Terra 5 NF, TLED	TR211-5NF-TLED	5	26 7/8"	5 1/8"
Terra 6 NF, TLED	TR263-6NF-TLED	6	24 3/8"	3 7/8"

Terra NF

Name	SKU	Faucets	Width	Distance between faucets
Terra 2 NF	TR188-2NF	2	13 5/16"	7 3/32"
Terra 3 NF	TR224-3NF	3	13 1/3"	4 1/2"
Terra 4 NF	TR230-4NF	4	18 1/8"	4 1/2"
Terra 5 NF	TR211-5NF	5	22 3/8"	5 1/2"
Terra 6 NF	TR263-6NF	6	24 1/4"	4"



Recommended Drip Trays

Tower	Drip Tray	Length	Width
Terra 2 NF	DTU15x5SS	15"	5"
Terra 2 NF, TLED			
Terra 3 NF			
Terra 3 NF, TLED	DTU20x7SS	20"	7"
Terra 4 NF			
Terra 4 NF, TLED	DTU30x7SS	30"	7"
Terra 5 NF			
Terra 5 NF, TLED			
Terra 6 NF			
Terra 6 NF, TLED			

STAINLESS STEEL TOWERS

TERRA BRANDED



- 304 Stainless Steel body
- Product Lines are 3/16" I.D and available in Vinyl or Stainless Steel
- Glycol Lines are Copper, 3/8" O.D.
- Cold blocks to prevent foaming during first pour
- Triple-layer moisture and thermal insulation of glycol and product lines

Terra Branded

Name	SKU	F	W	D
		aucets	idth	istance between faucets
Terra 2 BR	Terra-2 Branded	2	9 7/8"	5 1/8"
Terra 3 BR	Terra-3 Branded	3	15 7/8"	5 1/8"
Terra 4 BR	Terra-4 Branded	4	17 1/4"	3 7/8"
Terra 5 BR	Terra-5 Branded	5	26 7/8"	5 1/8"
Terra 6 BR	Terra-6 Branded	6	25"	3 7/8"



Custom branding on Face Plate for Terra Branded Towers



Available Finishing

Towers are available in several different finishes. A swatch can be seen on page 3. Contact your Sales Manager for further information.



TERRA **F** BRANDED

15 1/2"

3 3/16"

Recommended Drip Trays

Tower	Drip Tray	Length	Width
Terra 2/3	DTU15X5SS	12"	5"
Terra 4	DTU20X7SS	20"	7"
Terra 5	DTU24X7SS	24"	7"
Terra 6	DTU24X7SS	24"	7"
Terra 8	DTU30X7SS	30"	7"

UBC METRO TOWER



AVAILABLE IN 6, 8, 10, 12 & 14 FAUCET CONFIGURATIONS

- 304 Stainless Steel Body
- Triple-layer moisture & thermal insulation
- Power-coating options available
- Larger 4" diameter for a more significant appearance

More information & specifications available on page **33**

STAINLESS STEEL TOWERS

4" ARCADIA XL & 4" BRIDGE LED

- Larger 4" diameter for more significant look
- 304 Stainless Steel body
- Product Lines are 3/16" I.D and available in Vinyl or Stainless Steel
- Glycol Lines are Copper, 3/8" O.D.
- Triple-layer moisture and thermal insulation of glycol and product lines

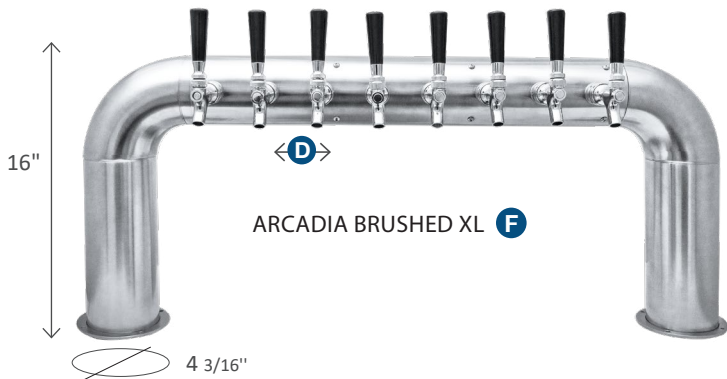

4" Arcadia XL, Brushed

Name	SKU	F aucets	W idth	D istance between faucets
4" Arcadia 8, No Flanges, Brushed	AC4B228-8NF	8	37 25/32"	2 15/16"

4" Arcadia XL, Polished

Name	SKU	F aucets	W idth	D istance between faucets
4" Arcadia 8, No Flanges, Polished	AC4P228-8NF	8	37 25/32"	2 15/16"



4" Bridge LED

Name	SKU	F aucets	W idth	D istance between faucets
Bridge 8 Front LED	UB-8FLED	8	40 3/4"	3 17/32"
Bridge 12 Front LED	UB-12FLED	12	55 1/8"	2 15/16"
Bridge 14 Front LED	UB-14FLED	14	61 13/32"	2 15/16"

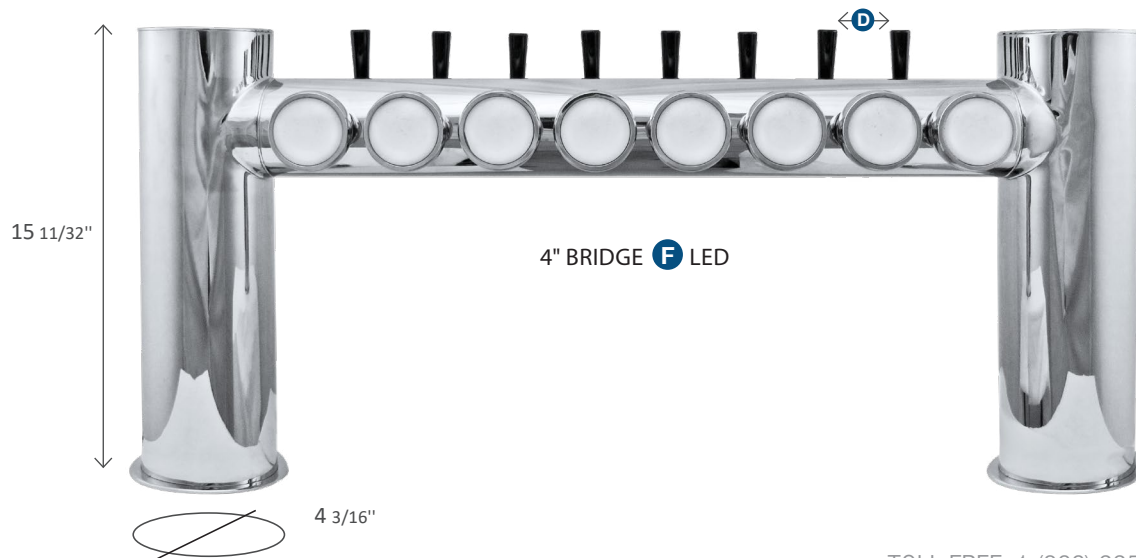

STAINLESS STEEL TOWERS

4" NORMA PASS THRU & 4" METRO

- Larger 4" diameter for more significant look
- 304 Stainless Steel body
- Product Lines are 3/16" I.D and available in Vinyl or Stainless Steel
- Glycol Lines are Copper, 3/8" O.D.
- Triple-layer moisture and thermal insulation of glycol and product lines



4" Norma Pass Thru

Name	SKU	F aucets	W idth	D istance between faucets
Norma 6	NM320-6	6	28 3/16"	3"
Norma 8	NM321-8	8	34 3/16"	3"
Norma 10	NM322-10	10	40 1/8"	3"
Norma 12	NM323-12	12	46 1/8"	3"
Norma 14	NM324-14	14	52 1/8"	3"
Norma 16	NM325-16	16	59 7/16"	3"

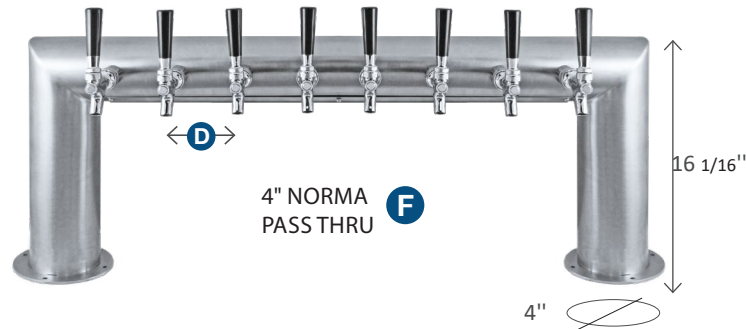

4" Metro Pass Thru

Name	SKU	F aucets	W idth	D istance between faucets
v 6	MR340-6	6	27 3/8"	3"
Metro 8	MR341-8	8	33 3/8"	3"
Metro 10	MR342-10	10	39 3/8"	3"
Metro 12	MR343-12	12	45 5/16"	3"
Metro 14	MR344-14	14	51 5/16"	3"
Metro 16	MR345-16	16	57 5/16"	3"

 Stainless Steel product lines
FOR BEER OR WINE



Available Finishing

Towers are available in several different finishes
A swatch can be seen on page 3.
Contact your Sales Manager for further information

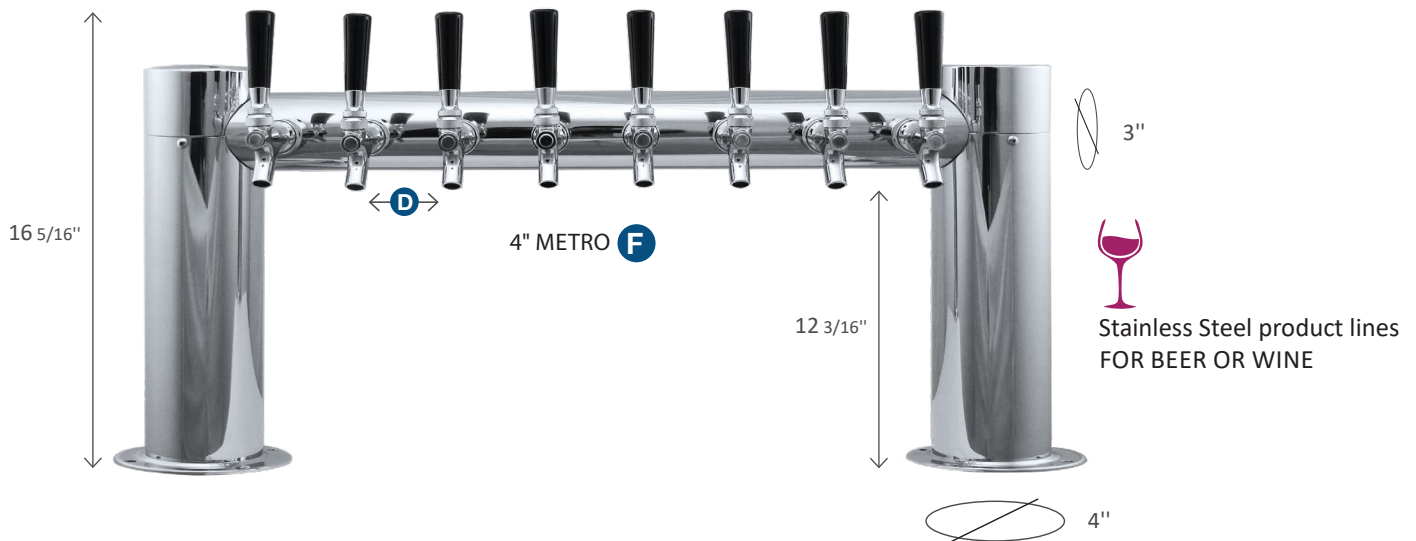



STAINLESS STEEL TOWERS YUKON

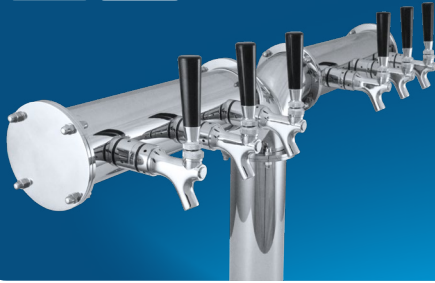

- 304 Stainless Steel body
- 3/8" Copper Glycol recirculation lines
- Cold blocks to prevent foaming during first pour
- Triple-layer moisture and thermal insulation of glycol and product lines

Yukon

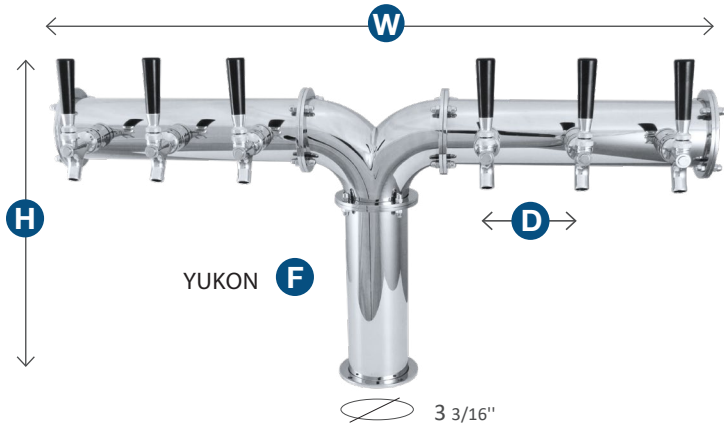

Name	SKU	Faucets	Width	Distance between faucets
Yukon 4	YK278-4T	4	25 7/8"	4 5/16"
Yukon 5	YK278-5T	5	30 1/4"	4 5/16"
Yukon 6	YK278-6T	6	34 9/16"	4 5/16"
Yukon 8	YK278-8T	8	51 3/4"	4 5/16"
Yukon 10	YK278-10T	10	60 1/2"	4 5/16"
Yukon 12	YK278-12T	12	67 13/16"	4 5/16"

NOTE: Yukon 8, 10, and 12 has 2 legs



Available Finishing

Towers are available in several different finishes
A swatch can be seen on page 3.
Contact your Sales Manager for further information



STAINLESS STEEL TOWERS

YUKON TOP LED

- 304 Stainless Steel body
- 3/8" Copper Glycol recirculation lines
- Cold blocks to prevent foaming during first pour
- Triple-layer moisture and thermal insulation of glycol and product lines



Yukon Top LED

Name	SKU	Faucets	Width	Distance between faucets
Yukon 4	YK278-4T	4	25 7/8"	4 5/16"
Yukon 5	YK278-5T	5	30 1/4"	4 5/16"
Yukon 6	YK278-6T	6	34 9/16"	4 5/16"
Yukon 8	YK278-8T	8	51 3/4"	4 5/16"
Yukon 10	YK278-10T	10	60 1/2"	4 5/16"
Yukon 12	YK278-12T	12	67 13/16"	4 5/16"

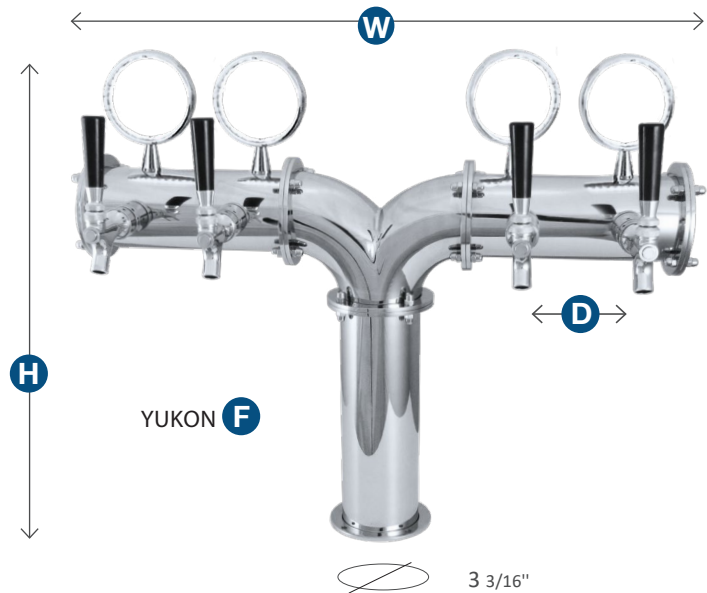

Recommended Drip Trays

Tower	Drip Tray	Length	Width	Rinser
Yukon 4	DTU24X7SS	24"	7"	YES
Yukon 5	DTU24X7SS	24"	7"	YES
Yukon 6	DTU36X7SS	36"	7"	YES
Yukon 8	DTU36X7SS+DTU20X7SS	56"	7"	YES
Yukon 10	DTU36X7SS +DTU24X7SS	60"	7"	YES
Yukon 12	DTU45X7SS + DTU24X7SS	68"	7"	YES



Available Finishing

Towers are available in several different finishes. A swatch can be seen on page 3. Contact your Sales Manager for further information.

AMERICAN STYLE TOWERS



American Style Towers

- Heavy duty design
- Glycol Cooled and Air Cooled
- 3" and 4" pedestal diameter

■ Cylinder Towers	38
■ Tee Box Towers	39
■ Double Pedestal Towers	40
■ Wall Mount & Under Bar Dispensers	41
■ Wall Mount Growler Drip Trays	42

NEW 4-FAUCET TOWER WITH A TRULY COMPACT DESIGN



- High quality 4" Column Tower with 4 faucets
- Stainless Steel body with a high level polish
- Cooling blocks to prevent foaming of beer at the tap
- Designed & Manufactured in Europe by UBC Group

More information & specifications available on the next page



AMERICAN STYLE TOWERS CYLINDER



- Ideal for special events
- 304 Stainless Steel body
- Optional Glycol or Air cooling
- 3/8" Copper Glycol recirculation lines

Cylinder

Name	SKU	Faucets	Height
3" Cylinder 1, Chrome, AIR	D4743T	1	12"
3" Cylinder 1, Chrome, GLYCOL	D4743TG	1	12"
3" Cylinder 1, Chrome, GLYCOL LED	D4743TG-LED	2	16 1/4"
3" Cylinder 2, Chrome, AIR	D4743DT	2	12"
3" Cylinder 2, Chrome, GLYCOL	D4743DTG	2	12"
3" Cylinder 2, 16" high, SS Faucets, Chrome, AIR	D16-2A-ASM	2	16"
3" Cylinder 3, Chrome, AIR	D4743TT	3	12"
3" Cylinder 3, Chrome, GLYCOL	D4743TTG	3	12"
3" Cylinder 3, Brushed SS, AIR, 14" High	D4743TT-14	3	14"
4" Cylinder 4, Polished SS, AIR	D4744TT-4	4	14"
4" Cylinder 4, Polished SS, GLYCOL	D4744TTG-4	4	14"



Tower Extensions

SKU	Description
ADD-1	3" Chrome Tower Extension from 1 to 2
ADD-2	3" Chrome Tower Extension from 1 to 3
ADD-3	3" Chrome Tower Extension from 2 to 3



Available Finishing

Towers are available in several different finishes. A swatch can be seen on page 3. Contact your Sales Manager for further information.



ADD-2



Recommended Drip Trays

SKU	Length	Width	Height	Rinser
DTU10x5SS	10"	5 1/2"	3/4"	NO
DTU12X7SS	12"	7"	3/4"	NO
DTB9	6 1/2"	6 1/2"	5"	NO

TOLL FREE: 1 (866) 995-9965, www.beer-co.ca

AMERICAN STYLE TOWERS

TEE BOX



- Well established and recognized design
- Optional Glycol or Air cooling
- Satin finish Stainless Steel body
- Product Lines are 3/16" I.D and available in Vinyl
- Glycol Lines are Copper, 3/8" O.D.

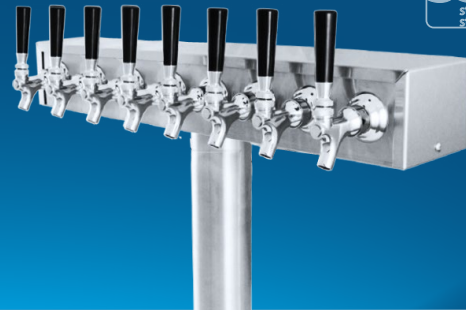

Tee Box

Name	SKU	Faucets	Width
D 3" Pedestal Tubes			
Tee Box 2, Chrome, AIR	TT2CR	2	10"
Tee Box 2, Chrome, GLYCOL	TT2CRG	2	10"
Tee Box 3, Chrome, AIR	TT3CR	3	10"
Tee Box 3, Chrome, GLYCOL	TT3CRG	3	10"
Tee Box 4, Chrome, AIR	TT4CR	4	13"
Tee Box 4, Chrome, GLYCOL	TT4CRG	4	13"
Tee Box 5, Chrome, AIR	TT5CR	5	16"
Tee Box 5, Chrome, GLYCOL	TT5CRG	5	16"
Tee Box 6, Chrome, AIR	TT6CR	6	19"
Tee Box 6, Chrome, GLYCOL	TT6CRG	6	19"
Tee Box 8, Chrome, AIR	TT8CR	8	25"
Tee Box 8, Chrome, GLYCOL	TT8CRG	8	25"

D 4" Pedestal Tubes			
Tee Box 6, Chrome, AIR	TTB6SS	6	19"
Tee Box 6, Chrome, GLYCOL	TTB6SSG	6	19"
Tee Box 8, Chrome, AIR	TTB8SS	8	25"
Tee Box 8, Chrome, GLYCOL	TTB8SSG	8	25"



Available Finishing

Towers are available in several different finishes
 A swatch can be seen on page 3.
 Contact your Sales Manager for further information

Recommended Drip Trays

SKU	Length	Width	Height	Rinsers
DTU24x5SS	24"	5 1/2"	3/4"	NO
DTU30x5SS	30"	5 1/2"	3/4"	NO
DTU36x5SS	36"	5 1/2"	3/4"	NO
DTU48x7SS	48"	7"	3/4"	NO



AMERICAN STYLE TOWERS DOUBLE PEDESTAL



- Well established and recognized design
- Optional Glycol or Air cooling
- Satin finish Stainless Steel body
- Product Lines are 3/16" I.D and available in Vinyl
- Glycol Lines are Copper, 3/8" O.D.

Double Pedestal

Name	SKU	Faucets	Width
------	-----	---------	-------

D 3" Pedestal Tubes

Double Pedestal 6, Chrome, AIR	PT6SS	6	19"
Double Pedestal 6, Chrome, GLYCOL	PT6SSG	6	19"
Double Pedestal 8, Chrome, AIR	PT8SS	8	25"
Double Pedestal 8, Chrome, GLYCOL	PT8SSG	8	25"
Double Pedestal 10, Chrome, AIR	PT10SS	10	31"
Double Pedestal 10, Chrome, GLYCOL	PT10SSG	10	31"
Double Pedestal 12, Chrome, AIR	PT12SS	12	37"
Double Pedestal 12, Chrome, GLYCOL	PT12SSG	12	37"

D 4" Pedestal Tubes

Double Pedestal 8, Chrome, AIR	PTB8SS-4	8	25"
Double Pedestal 8, Chrome, GLYCOL	PTB8SSG-4	8	25"
Double Pedestal 10, Chrome, AIR	PTB10SS-4	10	31"
Double Pedestal 10, Chrome, GLYCOL	PTB10SSG-4	10	31"
Double Pedestal 12, Chrome, AIR	PTB12SS-4	12	37"
Double Pedestal 12, Chrome, GLYCOL	PTB12SSG-4	12	37"
Double Pedestal 14, Chrome, AIR	PTB14SS-4	14	43"
Double Pedestal 14, Chrome, GLYCOL	PTB14SSG-4	14	43"
Double Pedestal 16, Chrome, AIR	PTB16SS-4	16	49"
Double Pedestal 16, Chrome, GLYCOL	PTB16SSG-4	16	49"

Recommended Drip Trays

SKU	Length	Width	Rinser
DTU24x5SS	24"	5 1/2"	NO
DTU20x7SS-CR	20"	7"	YES
DTU30x5SS	30"	5 1/2"	NO
DTU30x7SS-CR	30"	7"	YES
DTU36x7SS-CR	36"	7"	YES



Available Finishing

Towers are available in several different finishes
A swatch can be seen on page 3.
Contact your Sales Manager for further information



DOUBLE PEDESTAL F

AMERICAN STYLE TOWERS

WALL MOUNT DISPENSERS

- Well established and recognized design
- Optional Glycol or Air cooling
- Satin finish Stainless Steel body
- 3/8" Copper Glycol lines
- 3/16" Vinyl product lines



Wall Mount Dispensers

Name	SKU	Faucets	Width
Wall Mount 2, AIR	WMD15-2	2	15"
Wall Mount 2, GLYCOL	WMD15-2G	2	15"
Wall Mount 3, AIR	WMD15-3	3	15"
Wall Mount 3, GLYCOL	WMD15-3G	3	15"
Wall Mount 4, AIR	WMD15-4	4	15"
Wall Mount 4, GLYCOL	WMD15-4G	4	15"
Wall Mount 5, AIR	WMD24-5	5	24"
Wall Mount 5, GLYCOL	WMD24-5G	5	24"
Wall Mount 6, AIR	WMD24-6	6	24"
Wall Mount 6, GLYCOL	WMD24-6G	6	24"
Wall Mount 8, AIR	WMD30-8	8	30"
Wall Mount 8, GLYCOL	WMD30-8G	8	30"
Wall Mount 10, AIR	WMD36-10	10	36"
Wall Mount 10, GLYCOL	WMD36-10G	10	36"

WALL MOUNT **F**

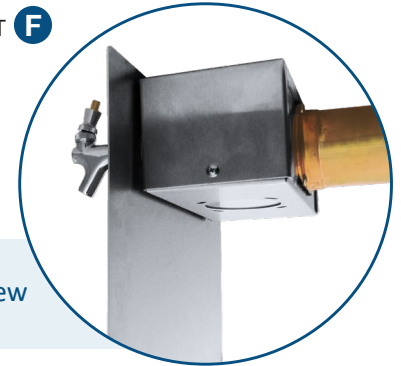

Backside View



UNDER BAR **F**

Under Bar Dispensers

Name	SKU	Faucets	Width
Under Bar 2, AIR	UBD15-2	2	15"
Under Bar 2, GLYCOL	UBD15-2G	2	15"
Under Bar 3, AIR	UBD15-3	3	15"
Under Bar 3, GLYCOL	UBD15-3G	3	15"
Under Bar 4, AIR	UBD15-4	4	15"
Under Bar 4, GLYCOL	UBD15-4G	4	15"
Under Bar 5, AIR	UBD24-5	5	24"
Under Bar 5, GLYCOL	UBD24-5G	5	24"
Under Bar 6, AIR	UBD24-6	6	24"
Under Bar 6, GLYCOL	UBD24-6G	6	24"
Under Bar 8, AIR	UBD30-8	8	30"
Under Bar 8, GLYCOL	UBD30-8G	8	30"
Under Bar 10, AIR	UBD36-10	10	36"
Under Bar 10, Glycol	UBD36-10	10	36"
Under Bar 12, GLYCOL	UBD36-10G	12	36"

Backside View

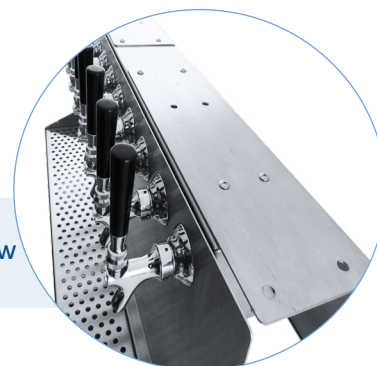

AMERICAN STYLE TOWERS WALL MOUNT GROWLER DRIP TRAY

- Ideal for growler filling out of taps on the wall
- Satin finish Stainless Steel body
- Customize how many holes and spacing between faucets
- Plenty of space between the drip tray and growler

Wall Mount Growler Drip Tray with Rinser

Name	SKU	SKU (Without Rinser)	Faucets	Width
Wall Mount Drip Tray UBC, up to 3 Faucets 12" x 8" x 19", Rinser	DTUWM12SSR	DTUWM12SS	1 - 3	12"
Wall Mount Drip Tray UBC, up to 5 Faucets 18" x 8" x 19", Rinser	DTUWM18SSR	DTUWM18SS	1 - 5	18"
Wall Mount Drip Tray UBC, up to 8 Faucets 24" x 8" x 19", Rinser	DTUWM24SSR	DTUWM24SS	1 - 8	24"
Wall Mount Drip Tray UBC, up to 10 Faucets 30" x 8" x 19", Rinser	DTUWM30SSR	DTUWM30SS	1 - 10	30"
Wall Mount Drip Tray UBC, up to 10 Faucets 32" x 8" x 19", Rinser	DTUWM32SSR	DTUWM32SS	1 - 10	32"
Wall Mount Drip Tray UBC, up to 12 Faucets 36" x 8" x 19", Rinser	DTUWM36SSR	DTUWM36SS	1 - 12	36"
Wall Mount Drip Tray UBC, up to 16 Faucets 48" x 8" x 19", Rinser	DTUWM48SSR	DTUWM48SS	1 - 16	48"



* Same sizes **without** rinsers also available

Faucets, shanks and growler fill tube sold separately



EUROPEAN AND ICE TOWERS



European and Ice Towers

- Exclusive appeal
- ICE towers will develop a layer of ice, perfect for mouth watering beer appeal
- The smooth frosted exterior makes an elegant statement on any bar top setting

■ Milano Towers	44
■ Venus & Brew Kettle Towers	46
■ TOF / Arcadia ICE Towers	47



EUROPEAN STYLE TOWERS MILANO

- 304 Stainless Steel product lines and shanks
- Recommended for wine and beer dispensing
- Glycol Lines are Copper, 3/8" O.D.
- Optional LED medallions

Milano

Name	SKU	F aucets	W idth
Milano 1, Chrome	MLN1C	1	4" (base width)
Milano 2, Chrome	MLN2C	2	5" (faucet to faucet)
Milano 3, Chrome	MLN3C	3	8" (faucet to faucet)
Milano 4, Chrome	MLN4C	4	10" (faucet to faucet)
Milano 1, Gold	MLN1G	1	4" (base width)
Milano 2, Gold	MLN2G	2	5" (faucet to faucet)
Milano 3, Gold	MLN3G	3	8" (faucet to faucet)
Milano 4, Gold	MLN4G	4	10" (faucet to faucet)

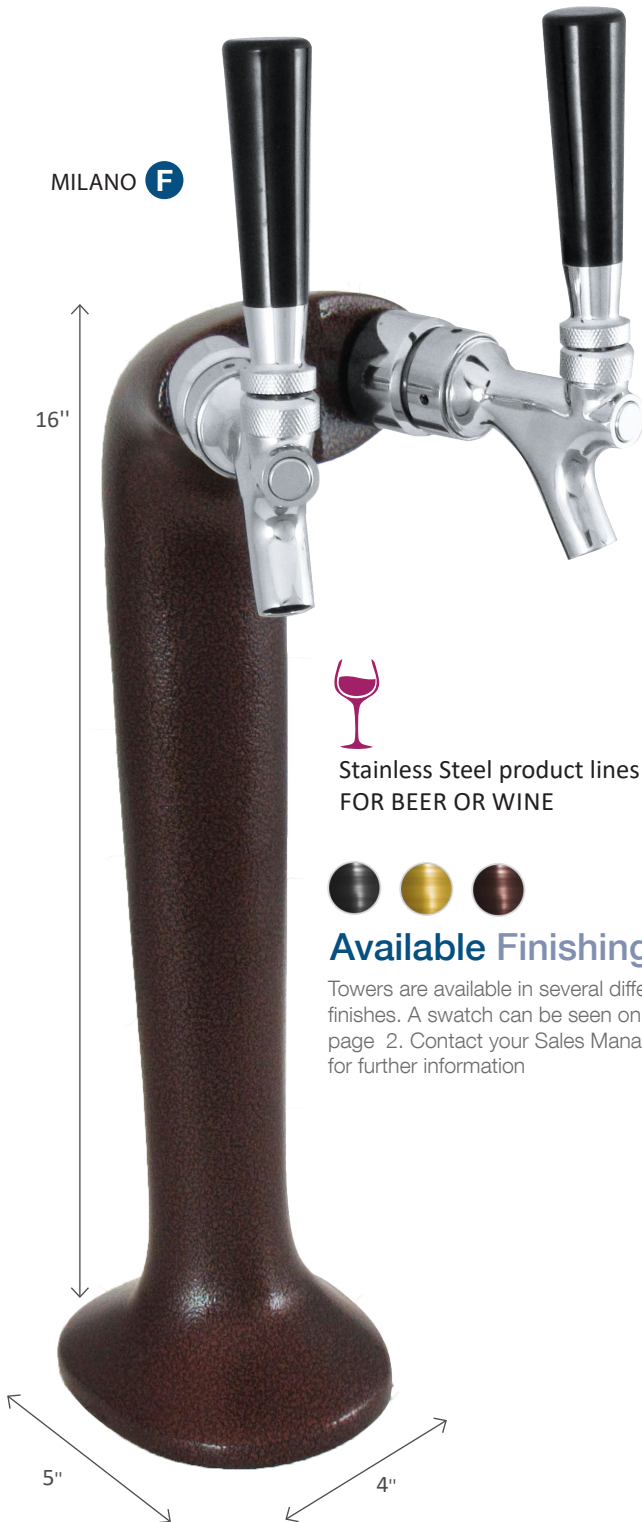

MILANO **F**

16"

5"

4"



Stainless Steel product lines
FOR BEER OR WINE



Available Finishing

Towers are available in several different finishes. A swatch can be seen on page 2. Contact your Sales Manager for further information

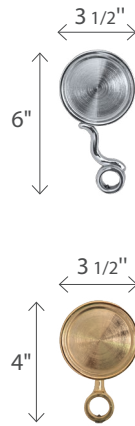

Non-LED Medallions

Available for non-LED towers

Name	SKU
Medallion, Chrome	MBRSC
Medallion, Gold	MBRSG
Medallion type S, Chrome	MBRSSC
Medallion type S, Gold	MBRSSC
Medallion type S, Gold	MBRSSG

Recommended Drip Trays

Tower	Drip Tray	Length	Width	Rinser
Milano 1 Milano 2	DTU10x5SS	10"	5 1/2"	NO
	DTU12X7SS-ND	12"	7"	NO
Milano 3	DTF16R	16"	15 3/4"	YES
	DTU12X7SS	12"	7"	NO
Milano 4	DTF16R	16"	15 3/4"	YES
	DTU16X7SS	16"	7"	NO
	DTF16R	16"	15 3/4"	YES

EUROPEAN STYLE TOWERS

MILANO LED

- 304 Stainless Steel product lines and shanks
- Recommended for wine and beer dispensing
- Product Lines are 3/16" I.D Stainless Steel
- Glycol Lines are Copper, 3/8" O.D.
- Top LED medallions



Milano LED

Name	SKU	Faucets	Width
Milano 2, Chrome, Top LED	MLN2LED	2	5"
Milano 3, Chrome, Top LED	MLN3LED	3	8"
Milano 4, Chrome, Top LED	MLN4LED	4	10"



Available Finishing

Towers are available in several different finishes
A swatch can be seen on page 3.
Contact your Sales Manager for further information

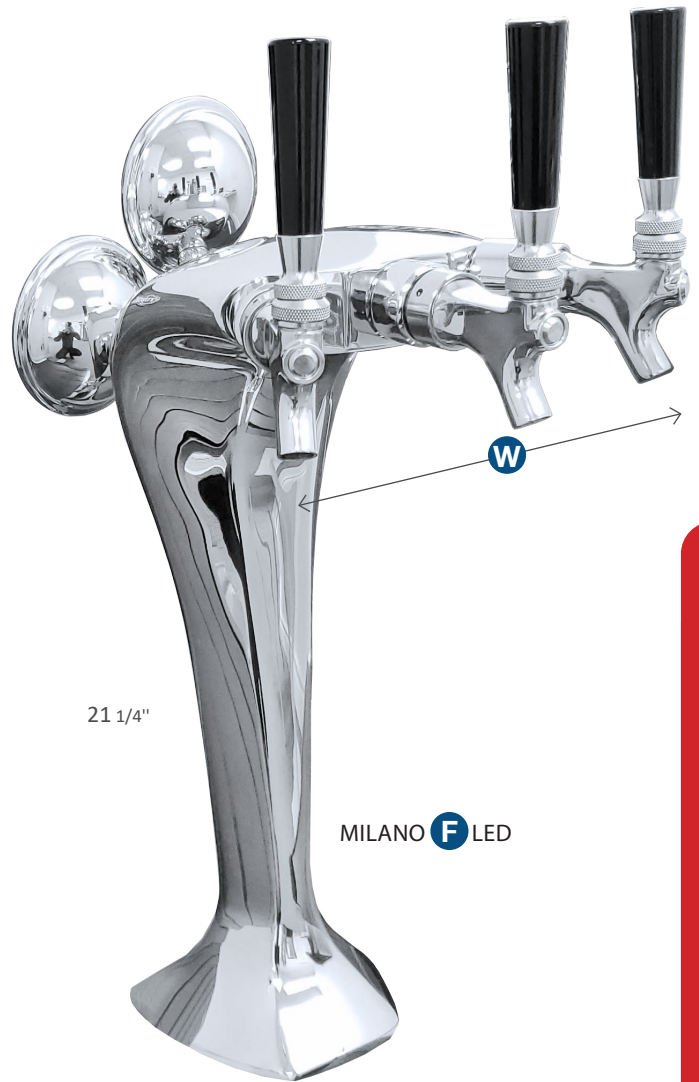

Recommended Drip Trays

Tower	Drip Tray	Length	Width	Rinser
MLN2LED	DTU10x5SS	10"	5"	NO
MLN3LED	DTU12x7SS	12"	7"	NO
MLN4LED	DTU16x7SS	16"	7"	NO

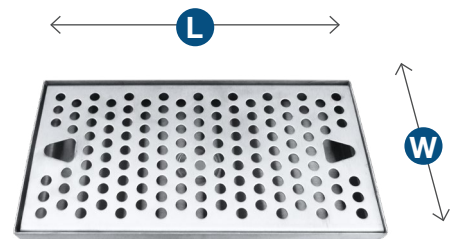

DTU10x5SS

EUROPEAN STYLE TOWERS

VENUS & BREW KETTLE



- 304 Stainless Steel product lines and shanks
- Recommended for wine and beer dispensing
- Product Lines are 3/16" I.D and available in Vinyl or Stainless Steel
- Glycol Lines are Copper, 3/8" O.D.



Venus

Name	SKU	F aucets	W idth
Venus 1, Chrome, LED*	VN1CLEd	1	3" (top)

Brew Kettle

Name	SKU	F aucets	W idth
Brew Kettle 1, LED	BK1LED	1	6 7/8"

Brew Kettle Accessories

SKU	Description
DTW9	Clamp-on Drip Tray, 9" x 6" for Brew Kettle, Wooden
SF2002	Stout Faucet for Brew Kettle, Stout St. Steel, Copper Finish



ICE TOWERS TOF, ARCADIA

- Designed to attract attention
- 304 Stainless Steel body
- Available with LED medallions
- Product Lines are 3/16" I.D and available in Vinyl or Stainless Steel
- Glycol Lines are Copper, 3/8" O.D.



TOF ICE Towers

Name	SKU	Faucets	H eight	W idth
TOF 2, ICE, Chrome, LED	TOF2CICELED	2	15 1/2"	5 1/2"
TOF 3, ICE, Chrome, LED	TOF3CICELED	3	15 1/2"	5 1/2"

Arcadia ICE Towers

Name	SKU	Faucets	H eight	W idth
Arcadia 4, ICE	AC-ICE4	4	16"	26 3/16"
Arcadia 8, ICE	AC-ICE8	8	16"	35 1/2"

Recommended Drip Trays

Tower	SKU	Width	Length	Rinser
TOF 2, Chrome, ICE	DTF16	15 3/4"	15 3/4"	NO
TOF 3, Chrome, ICE	DTF16R	15 3/4"	15 3/4"	YES
Arcadia 4, ICE	DTF32	15 3/4"	31 1/2"	NO
	DTF32R	15 3/4"	31 1/2"	YES

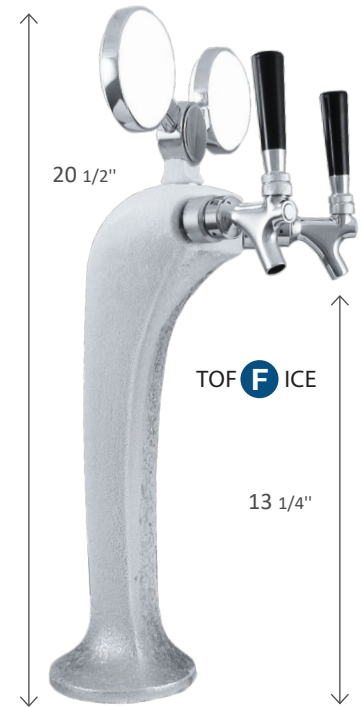

CERAMIC TOWERS



Ceramic Towers

- Add a unique traditional European look to any bar with beautiful ceramic towers
- Available in a variety of colors with your choice of Chrome or Brass hardware
- Permanent customized logos can be added to ceramic towers (set-up fees may apply)

CERAMIC TOWERS

SILVA

- Great retro style design
- Custom branding and other body colors available
- Towers are available in chrome or gold finish
- Product Lines are 3/16" I.D and available in Vinyl or Stainless Steel
- Glycol Lines are Copper, 3/8" O.D.



Silva 1-3

Name	SKU	Cooling	Faucets	Width
Silva 1	CTSL1	Air	1	7"
Silva 2	CTSL2	Air	2	7"
Silva 3	CTSL3	Air	3	12"
Silva 1	CTSL1G	Glycol	1	7"
Silva 2	CTSL2G	Glycol	2	7"
Silva 3	CTSL3G	Glycol	3	12"

Available in chrome or gold

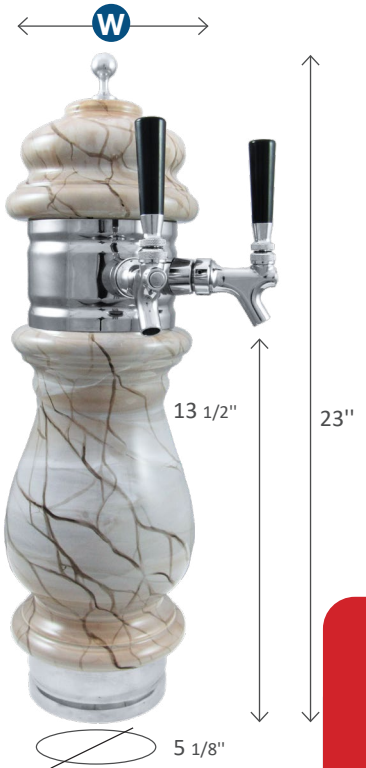

Silva 4-8

Name	SKU	Cooling	Faucets	Width
Silva 4	CTSL4	Air	4	12 1/4"
Silva 6	CTSL6	Air	6	17 3/4"
Silva 8	CTSL8	Air	8	23 5/16"
Silva 4	CTSL4G	Glycol	4	12 1/4"
Silva 6	CTSL6G	Glycol	6	17 3/4"
Silva 8	CTSL8G	Glycol	8	23 5/16"

SILVA F 1-3



SILVA F 4-8

Towers are stocked in

- Red
- White
- Black

100+ colors and patterns available upon special request



Custom Branding Available

FAUCETS AND SHANKS

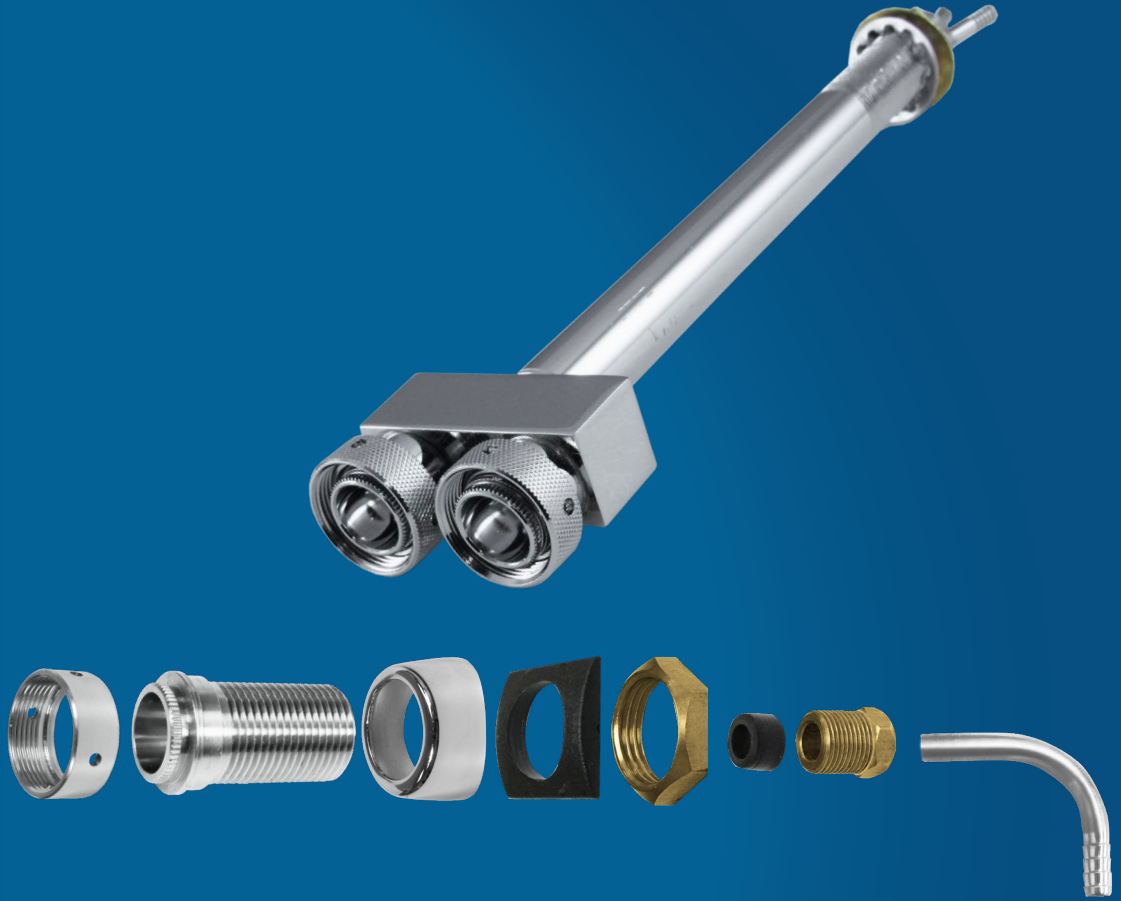

Faucets and Shanks

- Complete line of domestic and European shanks and faucets
- Full set of replacement faucet parts and accessories
- Innovative design - Domestic, European and Fast-Pour faucets
- 304 Stainless Steel or Brass faucets and shanks
- Industry standard quality of assembly and finishing

■ Tower Customization Parts	51
■ Domestic Faucets	53
■ Domestic Faucets Parts	54
■ Stout & Euro Faucets	55
■ Shanks & Parts	56

FAUCETS AND SHANKS

TOWER CUSTOMIZATION PARTS

- Parts to build custom towers
- Parts can be powder coated
- Design your own towers



Tower Parts

SKU	Description
TP-BODY5-1	Stainless Steel Body, 5mm, 1 Hole
TP-BODY5-2	Stainless Steel Body, 5mm, 2 Holes
TP-BODY5-2-WIDE	Stainless Steel Body, 5mm, 2 Holes Wide Apart
TP-BODY5-3	Stainless Steel Body, 5mm, 3 Holes
TP-BODY5-3-WIDE	Stainless Steel Body, 5mm, 3 Holes Wide Apart
TP-BODY3-G	Stainless Steel Body, 5mm, 3 Holes, Gold
TP-BODY5-4	Stainless Steel Body, 5mm, 4 Holes
TP-BODY5-4-WIDE	Stainless Steel Body, 5mm, 4 Holes Wide Apart
TP-BODY4-G	Stainless Steel Body, 5mm, 4 Holes, Gold
TP-BODY5-5	Stainless Steel Body, 5mm, 5 Holes
TP-LEG8-5	Stainless Steel Leg, 5mm, 8 3/4"
TP-LEG8-G	Stainless Steel Leg, 8 3/4", Gold
TP-LEG10-5	Stainless Steel Leg, 5 mm, 10"
TP-LEG10-G	Stainless Steel Leg, 10", Gold
TP-LEG12-5	Stainless Steel Leg, 5mm, 12 2/4"
TP-LEG12-G	Stainless Steel Leg, 12 2/4", Gold
TP-ELBOW5	Stainless Steel 90 Degree Elbow, 5mm
TP-ELBOWG5	Stainless Steel 90 Degree Elbow, 5mm, Gold
TP-TEE5	Stainless Steel Tee, 5mm
TP-TEE5-1	Stainless Steel Tee, 5mm, 1 Hole
TP-TEE5-2	Stainless Steel Tee, 5mm, 2 Hole
TP-TEE5-L	Stainless Steel Tee, 5mm, Long
TP-TEE5-X	Stainless Steel Tee, 5mm, X
TP-SIDE5	Stainless Steel Side Cover, 5mm
TP-SIDE5-1	Stainless Steel Side Cover, 5mm, 1 Hole
TP6212	3" Rubber Gasket



TP-BODY2



TP-BODY3-WIDE



TP-BODY5



TP-LEG8-5



TP-LEG10-G



TP-LEG14-5



TP-TEE5



TP-TEE5-1



TP-TEE5-X

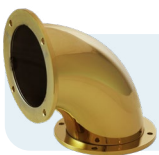

Powder Coating Available



TP-SIDE5-1-G



TP-SIDE5-1



TP-TEE5-L



TP-TEE5-2

FAUCETS AND SHANKS

TOWER CUSTOMIZATION PARTS

- Parts to build custom towers
- Parts can be powder coated
- Design your own towers



Tower Inserts

Vinyl SKU	Stainless Steel SKU	Description
TP-ASM4L	TP-ASM4LSS	Internal 4 Lines Tower Assembly, Left
TP-ASM4R	TP-ASM4RSS	Internal 4 Lines Tower Assembly, Right
TP-ASM5L	TP-ASM5LSS	Internal 5 Lines Tower Assembly, Right
TP-ASM5R	TP-ASM5RSS	Internal 5 Lines Tower Assembly, Right
TP-ASM6L	TP-ASM6LSS	Internal 6 Lines Tower Assembly, Left
TP-ASM6R	TP-ASM6RSS	Internal 6 Lines Tower Assembly, Right
TP-ASM8L	TP-ASM8LSS	Internal 8 Lines Tower Assembly, Left
TP-ASM8R	TP-ASM8RSS	Internal 8 Lines Tower Assembly, Right

Tower Assembly Parts

SKU	Description
CRT23	3/8" OD Copper Refrigeration Loop, 23"
CRT3/8	3/8" OD Copper Refrigeration Tube, 1'
TP6212	3" Rubber Gasket

Stainless Steel Insert Kits

SKU	Description
SPMSS-SH1	SPM Shank for SS Lines, 1.5"
SPMSS-TW	Tightning Threaded Coupling for SPMSS-SH1
SPM-TW	Tightning Thread Washer for SPM Shanks
SPM-CR	External Concaved SS Ring for SPM Shanks
SPM-TI	Thermo-Insulating Plastic Insert for SPM Shanks
SPM-G	Fluoroplastic Inside Gasket for SPM Shank/Cold Block
SHP6006	Chrome Coupling Nut

Vinyl Insert Kits

SKU	Description
SPM-SH2	SPM Shank for Vinyl Lines, 2"
SPM-SH3	SPM Shank for Vinyl Lines, 3"
SPM-TW	Tightning Thread Washer for SPM Shanks
SPM-CR	External Concaved SS Ring for SPM Shanks
SPM-TI	Thermo-Insulating Plastic Insert for SPM Shanks
SPM-G	Fluoroplastic Inside Gasket for SPM Shank/Cold Block
SHP6006	Chrome Coupling Nut

FAUCETS AND SHANKS

DOMESTIC FAUCETS



- 304 Grade Stainless Steel
- Gold plated Brass
- Chrome plated Brass
- Flow control options

Domestic Faucets

SKU	Description
BF1001	Polished Brass, Chrome plated, Brass Lever
BF1002	Polished Brass, Chrome plated, St. Steel Lever
BF1002SS	Polished Stainless Steel
BF1003	Polished Brass, Brass Lever
BF1003SS	Brass/Gold Plated, Stainless Steel
BF1005	Polished Brass, Chrome Plated, St.Steel Lever, made in Italy
BF630SS	Stainless Steel, Perlick
BF650SS	Stainless Steel, Flow Control, Perlick
BFT1007	Chrome, Stainless Steel Spout, TOF
BFC304SS	Polished Stainless Steel, S/S Spout
BFC304SSF	Stainless Steel, Flow Control, Back Shot, S/S Spout
BFM304	Polished Stainless Steel 304, Micro Matic



BF1001



BF1002
BF1002SS



BF1003
BF1003SS



BF1005



BF630SS



BF650SS



BFM304



BFC304SSF



BFC304SS



BFT1007

FAUCETS AND SHANKS

DOMESTIC FAUCET PARTS

- 304 Grade Stainless Steel
- Gold plated Brass
- Chrome plated Brass

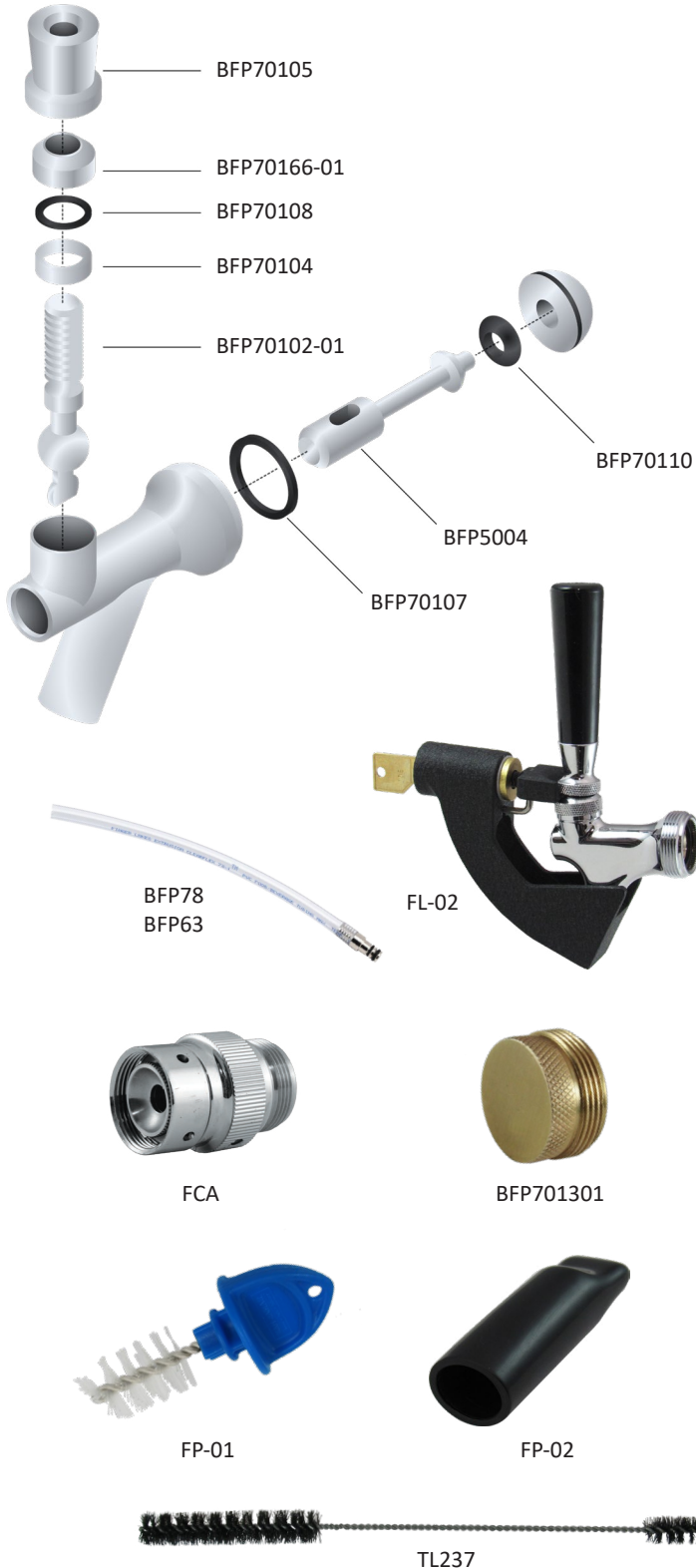

Faucet Parts

SKU	Description
PL.H	Plastic Black Handle
BFP70105	Faucet Collar, Chrome
BFP70106	Faucet Collar, Brass
BFP70166-01	Faucet Bonnet, Chrome
BFP70166-02	Faucet Bonnet, Brass
BFP70108	Friction Washer
BFP70104	Ball Washer
BFP70102-01	Faucet Lever, Brass
BFP70102-02	St. Steel Faucet Lever
BFP70107	Body Gasket / Faucet Washer
BFP5004	Faucet Shaft Assembly, Chrome
BFP70103-03	Faucet Shaft Assembly, Brass
BFP70110	Faucet Shaft Seal

Faucet Accessories

SKU	Description
BFP14	SS Stout Spout, Intertap
BFP78	Stainless Steel Growler Tube Filler for Domestic Faucet
BFP63	Stainless Steel Growler Tube Filler for Perlick 630 / 650
BFP129	Angled Ferrule Adapter to Tilt Tap Handle, Chrome
BFP70130	Faucet Plug, Brass
FCA	Flow Control Adapter
FL-02	Faucet Lock with Nozzle Cover
FP-01	Faucet Brush Plug
FP-02	Faucet Rubber Plug
TL237	Faucet Brush, Double Sided
TL271	Faucet Brush

FAUCETS AND SHANKS

STOUT & EURO FAUCETS

- 304 Grade Stainless Steel
- Gold plated Brass
- Chrome plated Brass

Stout Faucets

SKU	Description
SF2000	Stout Brass Faucet
SF2001	Chrome Stout Faucet

Stout Faucet Parts

SKU	Description
SFP001	Stout Faucet Flow Straightener
SFP002	Stout Faucet O-Ring
SFP003	Stout Faucet Creamer Plate 0.3mm
SFP016	Stout Faucet St. Steel Nozzle



SF2000



SF2001

Euro Flow Control Faucets

SKU	Description
BFE3000	Polished Brass, Gold plated, Flow Control, Self Closing, S/S Spout, with Shank
BFE3001	Polished Brass, Chrome plated, Flow Control, Self Closing, S/S Spout, with Shank
BFE3002	Euro Faucet, Ball type, Brass, Flow Control, with Shank
BFE3003	Euro Faucet, Ball type, Brass, Chrome plated, Flow Control, with Shank



SFP001



SFP002

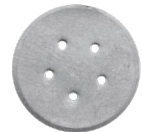

SFP003



SFP016



BFE3000



BFE3001



BFE3003

FAUCETS AND SHANKS

SHANKS & PARTS

- 304 Stainless Steel or Brass shanks
- Available in a variety of sizes
- Chrome or Brass spacers

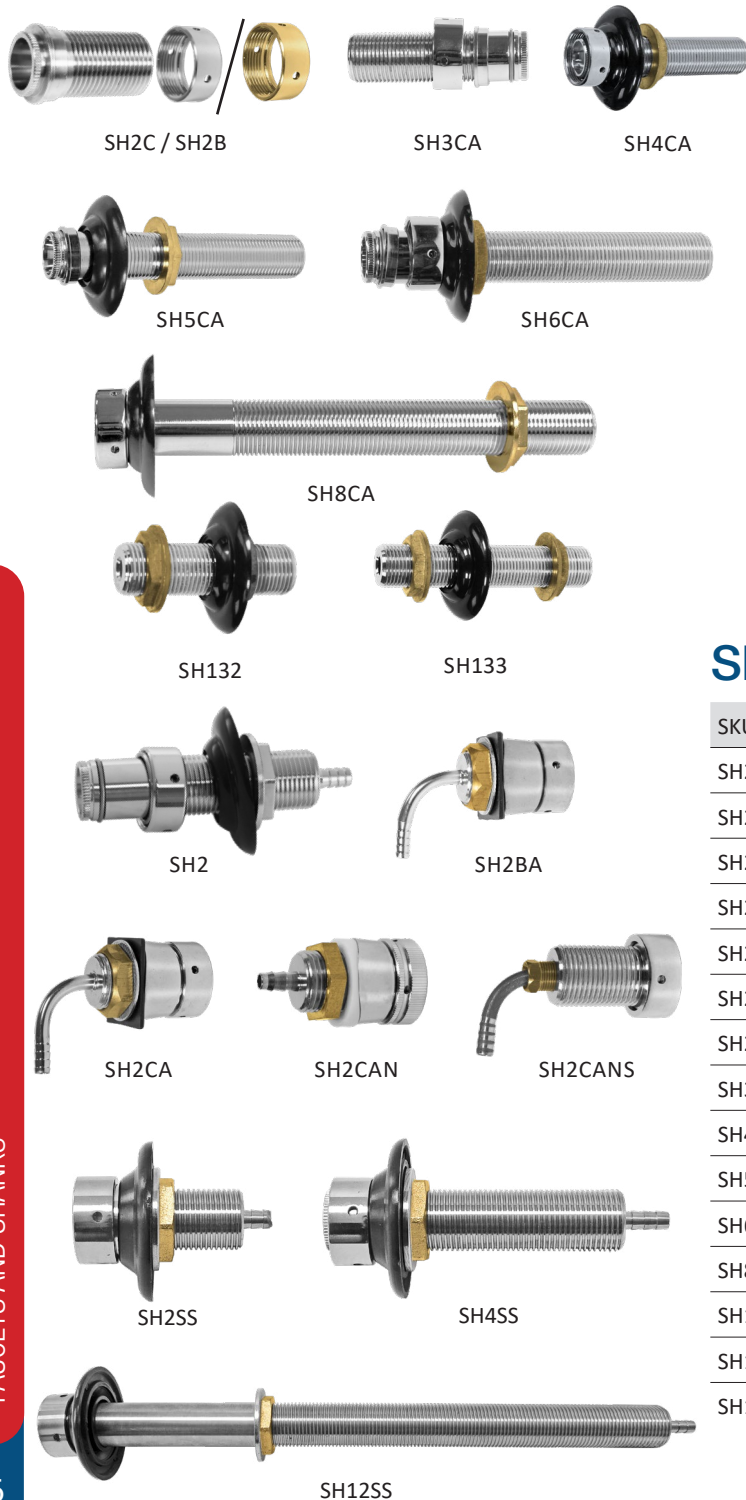

Shank Assembly Without Nipple

SKU	Description
SH2C	1 3/4" with 3/16" bore, SS, chrome coupling nut
SH2B	1 3/4" with 3/16" bore, SS, brass coupling nut
SH3CA	3 1/8" with 3/16" bore
SH4CA	4 1/8" with 3/16" bore
SH5CA	5 1/8" with 3/16" bore
SH6CA	6 1/8" with 3/16" bore
SH8CA	8 1/8" with 3/16" bore
SH10CA	10 1/8" with 3/16" bore
SH12CA	12 1/8" with 3/16" bore
SH3CA14SS	Stainless Steel, 3 1/8" with 1/4" bore
SH132	Cooler coupling, 3" assembly, 5/16" bore
SH133	Cooler coupling 4" assembly, 5/16" bore

Shank Assembly With Nipple

SKU	Description
SH2BA	1 3/4" with 3/16" bore & elbow, brass coupling nut & spacer
SH2CA	1 3/4" with 3/16" bore & elbow, chrome coupling nut & spacer
SH2BAN	1 3/4" with 3/16" bore & nipple, brass coupling nut & spacer
SH2CAN	1 3/4" with 3/16" bore & nipple, chrome coupling nut, spacer
SH2BANS	2 1/4" with 3/16" bore & spinning elbow, brass coupling nut & spacer
SH2CANS	2 1/4" with 3/16" bore & spinning elbow, chrome coupling nut & spacer
SH2SS	Stainless Steel 2 1/8" with 3/16" Bore and Nipple
SH3SS	Stainless Steel 3 1/8" with 3/16" Bore and Nipple
SH4SS	Stainless Steel 4 1/8" with 3/16" Bore and Nipple
SH5SS	Stainless Steel 5 1/8" with 3/16" Bore and Nipple
SH6SS	Stainless Steel 6 1/8" with 3/16" Bore and Nipple
SH8SS	Stainless Steel 8 1/8" with 3/16" Bore and Nipple
SH10SS	Stainless Steel 10 1/8" with 3/16" Bore and Nipple
SH12SS	Stainless Steel 12 1/8" with 3/16" Bore and Nipple
SH14SS	Stainless Steel 14 1/8" with 3/16" Bore and Nipple

FAUCETS AND SHANKS

SHANKS & PARTS

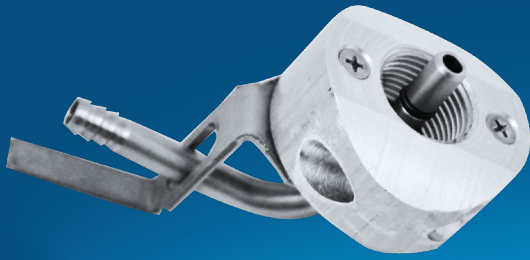

- 304 Stainless Steel or Brass shanks
- Available in a variety of sizes
- Chrome or Gold spacers
- Full line of replacement parts

Compression Shank Assembly



Shank Replacement Parts

SKU	Description
SHCT2	Compression Shank - 1 3/4"
SHP001	SS 3/16" Tube x 3/16" Barb Elbow
SHP012	Locking Flange for Wall Shank Assembly
SHP015	Plastic Black Outer Flange - 4"
SHP002	Compression Nut
SHP003	Grommet Gland
SHP003E	Grommet Gland for Indented European Shank
SHP004	Lock Nut for Tower
SHP005	Plastic Spacer
SHP006	Sleeve
SHP007	Snap Ring
SHP009	SS Outer Flange - 4"
SHP011	Brass Lock Nut
SHP010	7/8" Zink Lock Washer
SHP013	Cooler Coupling / Shank Washer
SHP228	Cold Block Brass
SHP6006	Chrome Coupling Nut
SHP7007	Brass Coupling Nut
SHSPMA	SPM Cold Block Assembly
SPB1	3/4" Brass Spacer
SPC2	3/4" Chrome Spacer
SPCC3	Curved Chrome Outer Flange - 3"



DRIP TRAYS

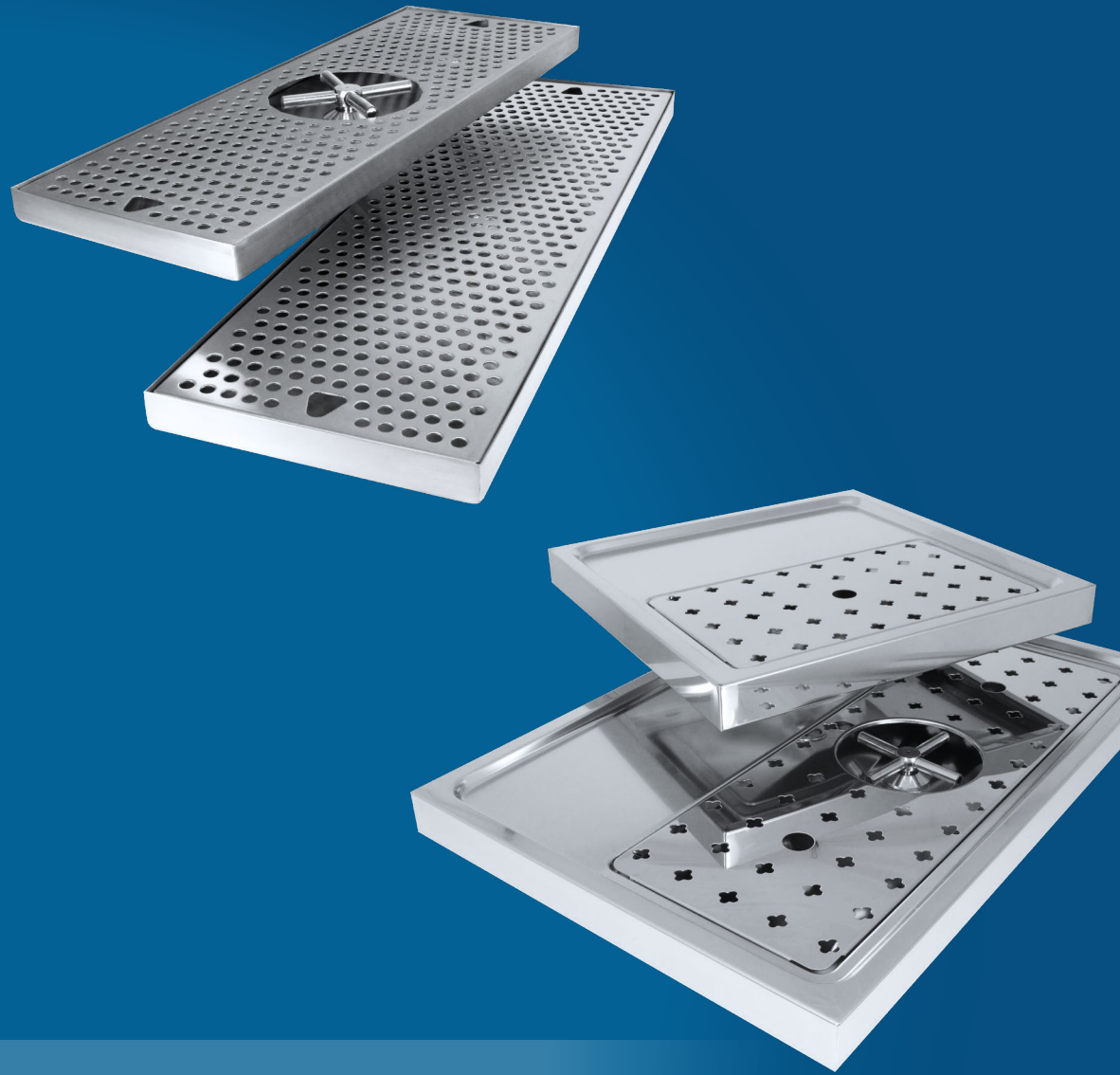

Drip Trays

- Complete line of 304 Stainless Steel drip trays
- Drip Trays for both permanent and mobile situations
- Glass Rinser options available for most drip trays (not all)

■ Countertop Drip Trays	59
■ Platform Drip Trays	60
■ Drip Tray Wall Mount & Drip Tray Parts	61
■ Clamp-on Drip Trays	62
■ Glass Rinser Drip Trays	62

DRIP TRAYS

COUNTERTOP DRIP TRAYS

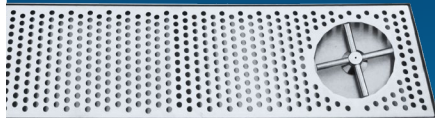

- Designed for permanent or mobile use
- 304 Grade Stainless Steel
- Available with or without a glass rinser
- All drip trays standard with drain
- Variety of sizes and shapes

Countertop Drip Tray

SKU	L ength	W idth	Rinser
DT8SS	8"	5 1/2"	NO
DTU10x5SS	10"	5"	NO
DTU12x7SS	12"	7"	NO
DTU15x5SS	15"	5"	NO
DTU16x7SS	16"	7"	NO
DTU20x5SS	20"	5"	NO
DTU20x7SS	20"	7"	NO
DTU24x5SS	24"	5"	NO
DTU24x7SS	24"	7"	NO

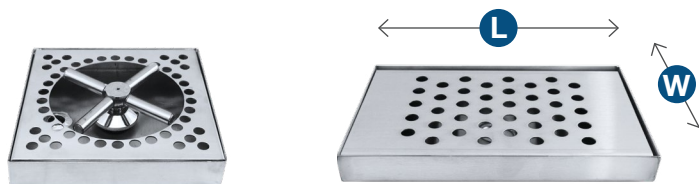

DT361

DTU **L** SS

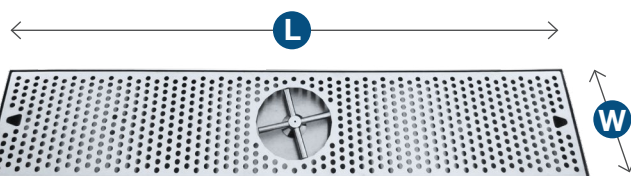

DTU **L** X **W** SS-CR

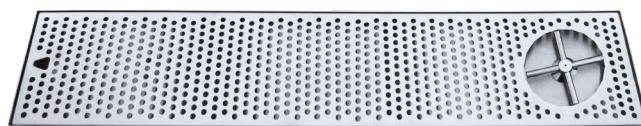

DTU **L** X **W** SS-SR

Countertop Drip Tray with Rinser

SKU	L ength	W idth	Rinser
DT360	11" (w/ flange)	6 1/2"	YES
DT361	6 1/2"	6 1/2"	YES
DTU10X5SS-CR	10"	5"	YES
DTU15X5SS-CR	15"	5"	YES
DTU20X5SS-CR	20"	5"	YES
DTU20X7SS-CR	20"	7"	YES
DTU20X7SS-SR	20"	7"	YES
DTU24X5SS-CR	24"	5"	YES
DTU24X7SS-CR	24"	7"	YES
DTU24X7SS-SR	24"	7"	YES
DTU30X7SS-CR	30"	7"	YES
DTU30X7SS-SR	30"	7"	YES
DTU36X5SS-CR	36"	5"	YES
DTU36X7SS-CR	36"	7"	YES
DTU36X7SS-SR	36"	7"	YES
DTU45x7SS-CR	45"	7"	YES
DTU45x7SS-SR	45"	7"	YES
DTU48x5SS-CR	48"	5"	YES
DTU48x7SS-CR	48"	7"	YES
DTU48x7SS-SR	48"	7"	YES
DTU54x7SS-CR	54"	7"	YES
DTU54x7SS-SR	54"	7"	YES

Countertop Drip Tray, No Drain

SKU	L ength	W idth	Rinser
DTU10X5SS-ND	10"	5"	No
DTU12x7SS-ND	12"	7"	No
DTU15X5SS-ND	15"	5"	No
DTU16x8SS-ND	16"	8"	No
DT24SS-ND	24"	5 1/2"	No

Countertop Drip Tray, Recessed

SKU	L ength	W idth	Rinser
DTU12X7SS-ND Recessed	12"	7"	No
DTU16X8SS-ND Recessed	16"	8"	No

DRIP TRAYS

PLATFORM DRIP TRAYS

- Designed for beer tower to be mounted on top of the tray
- Keeps condensation and spillage away from countertop
- Ideal for ICE towers

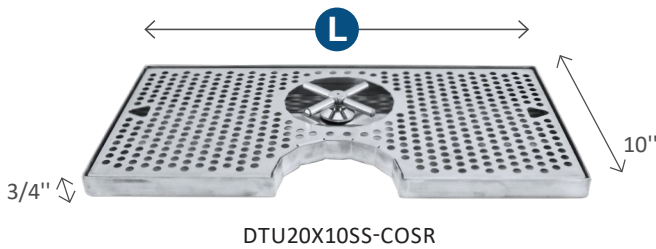
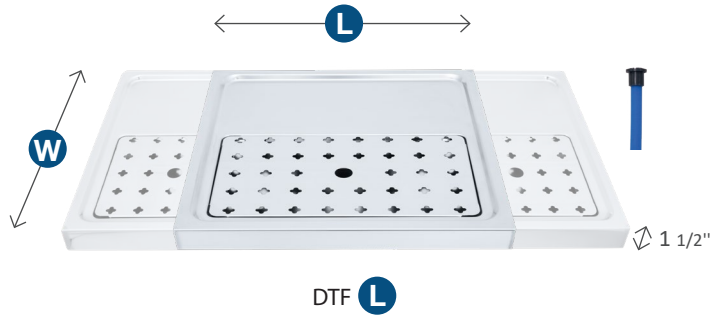

Platform Drip Trays

SKU	L ength	W idth	Rinser
DTF16	15 3/4"	15 3/4"	NO
DTF24	23 5/8"	15 3/4"	NO
DTF28	27 9/16"	15 3/4"	NO
DTF32	31 1/2"	15 3/4"	NO
DTF40	39 3/8"	15 3/4"	NO
DTF48	47 1/2"	19 5/8"	NO
DTF16R	15 3/4"	15 3/4"	YES
DTF24R	23 5/8"	15 3/4"	YES
DTF28R	27 9/16"	15 3/4"	YES
DTF32R	31 1/2"	15 3/4"	YES
DTF40R	39 3/8"	15 3/4"	YES
DTFC32R	31 1/2"	15 5/8"	YES
DTFC40R	39 3/8"	15 5/8"	YES
DTFC48R	47 1/2"	19 5/8"	YES

Cut Out Drip Trays

SKU	L ength	W idth	Rinser
DTU20X10SS-COSR	20"	10"	YES
DTU28X10SS-COSR	28"	10"	YES
DTU28X10SSG-COSR	28"	10"	YES
DTU33X10SS-COSR	33"	10"	YES

All Drip Trays come standard with drain



DRIP TRAYS

DRIP TRAY WALL MOUNTS

DRIP TRAY PARTS



- Drip Trays can easily attach to refrigerators and walls
- Full line of drip tray accessories

Drip Tray Wall Mounts

SKU	Faucets	Length	Width	Height
DTWM8SS	Up to 3	8"	6 1/2"	14"
DTWM15SS	Up to 5	15"	6 1/2"	14"
DTWM24SS	Up to 8	24"	6 1/2"	14"
DTWM30SS	Up to 10	30"	6 1/2"	14"
DTWM36SS	Up to 12	36"	6 1/2"	14"



*NOTE: Drip Tray Wall Mounts do not come standard with faucets or holes. Please advise your sales representative of how you would like your Drip Tray Wall Mount configured.

Drip Tray Parts

SKU	Description
DTP-RIN	Metal Rinser Assembly
DTPC-RINP	Plastic Rinser Assembly
DTP002B	2" Threaded Metal Drain
DTP004B	4" Threaded Metal Drain
DTP006M	6.5" Threaded Metal Drain
DTP004P	4" Threaded Plastic Drain
DTP006P	6" Threaded Plastic Drain
DTP100D	Female Metal Drain Fitting for 1/2" Hose
DTP205F	Female Drain Fitting for 1/2" Hose - Plastic Flange Adapter
DTP205M	Threaded Top Piece of Female Drain Fitting (DTP205F)
DTP-RP-RIN	Metal Rinser Assembly, Round Plate
DTP-PIN	Metal Rinser Stainless Steel Pin Assembly
JGPI451214FS	Gray Acetal Female Connector 3/8" x 1/2" BSPP

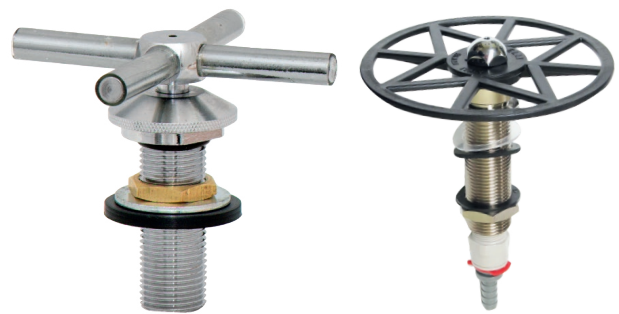

DTP-RIN

DTPC-RINP



DTP002B

DTP006M

DTP004P



DTP006P

DTP100D

DTP205F

DTP-PIN

JGPI451214FS

DRIP TRAYS

CLAMP-ON DRIP TRAY GLASS RINSER DRIP TRAY



- Ideal solution for mobile or special event
- Designed for use with various towers
- Available in Chrome or Black finishing
- Stainless Steel drip tray grid

Clamp-on Drip Trays

SKU	Description
DTB9	9" x 6" clamp-on black

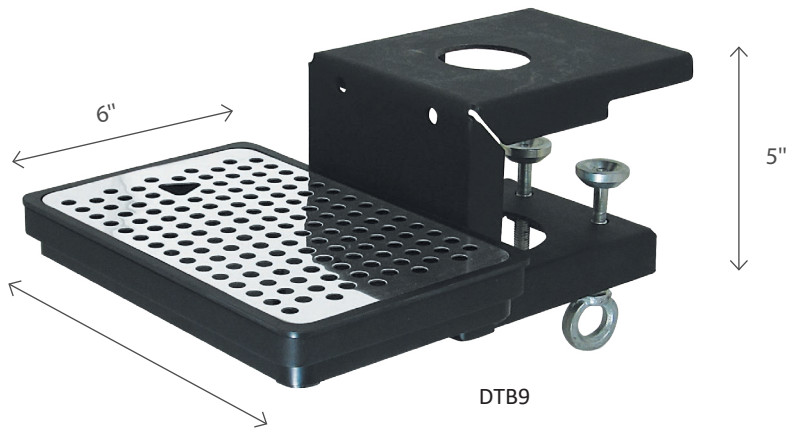

NOTE: Clamp-on Drip Tray can hold all American, Gothic, and Milano towers

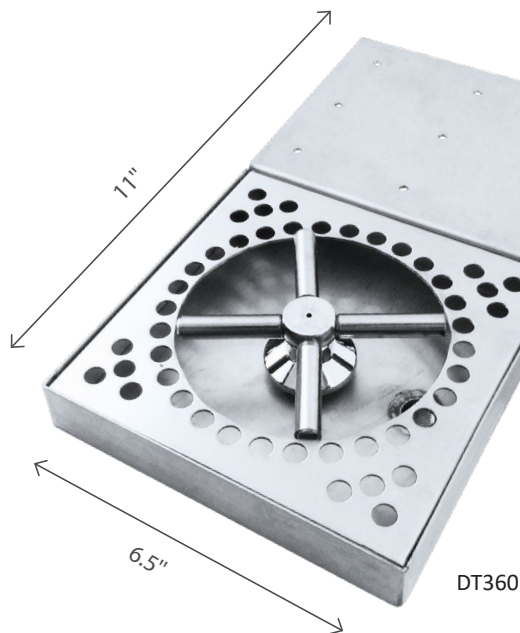

Glass Rinser Drip Tray

SKU	Description
DT360	Glass Rinser Drip Tray, with Side Mounting Flange

GLYCOL POWER PACKS



Glycol Power Packs

- Easier to install, service and maintain
- Large condenser for hot ambient conditions
- High-Efficiency Evaporator shaped for optimal use of the glycol bath
- Digital thermostat for easier maintenance
- Environmentally friendly HFC-Free insulation
- Pump Saver - Dumper coupling assembly included for additional safety to prevent damage to the pump(s)

BEER AND BEVERAGE COOLING SYSTEMS

GLYCOL POWER PACKS

- Vertical or horizontal body for a better use of available space
- Digital thermostats on all models
- Optional 6" legs

Glycol Power Packs

Name	KALINKA ICE	KALINKA V-ICE
Part Number	KG-1/6VP	KGVU-1/6VP
Maximum Distance, ft	up to 40'	
Capacity, BTU/hr evap 20f	1150	
Glycol tank capacity, gal	2	1.5
Voltage, Volt/Hz	115/60	
Dedicated Circuit, amp	15	
Compressor Power, hp	1/7+	
Pump Type	MID-5 or FloJet SPC42	
Pumps	1	
Pump Capacity	135	
Thermostat	Digital	
Refrigerant	R134a	R-290
Rubber Feet	Yes	
Dimensions W x D x H , in	18x17x12	11x17x23
Weight Gross/Net, lbs	52/45	61/51



KALINKA V-ICE
KGVU-1/6VP
(Vertical Pump)



KG-1/6VP
(Vertical Pump)

BEER AND BEVERAGE COOLING SYSTEMS GLYCOL POWER PACKS

- Vertical or horizontal body for better use of available space
- Digital thermostats on all models
- Optional 6" legs

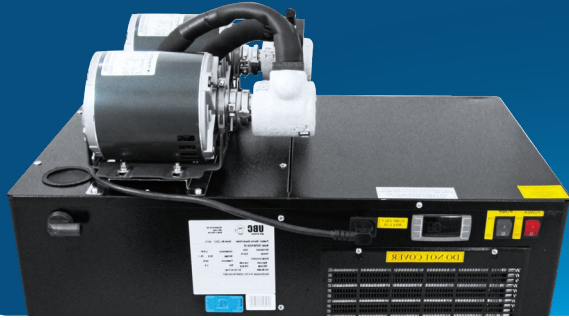

Glycol Power Packs

Name	H35G-3/8VP VERTICAL PUMP	H35G-3/8GP ROTARY PUMP	H35G-3/8GP-ASM 2 X ROTARY PUMPS
Part Number	H35G-3/8VP	H35G-3/8GP	H35G-3/8GP-ASM
Maximum Distance, ft	75'	125'	
Capacity, BTU/hr evap 20f	3200		
Glycol tank capacity, gal	5.8		
Voltage, Volt/Hz	115/60		
Dedicated Circuit, amp	15		
Compressor Power, hp	3/8		
Pump Type	MID-5 or Flojet SPC42	50-100gal/hr	
Pumps	1	2	
Pump Capacity, GPH	240	80	
Thermostat	Digital		
Refrigerant	R134a		
Legs (Sold Separately)	6"		
Dimensions W x D x H , in	30x18x18	30x18x19	
Weight Gross/Net, lbs	93/83	99/88	



H35G-3/8GP
(Rotary Vane Pump)



H35G-3/8VP
(Vertical Pump)



H35G-3/8GP-ASM
(Rotary Vane Pumps)



BEER AND BEVERAGE COOLING SYSTEMS

GLYCOL POWER PACKS

- Vertical or horizontal body for a better use of available space
- Digital thermostats on all models
- Optional 6" legs



Glycol Power Packs

Name	H75G-3/8VP VERTICAL PUMP	H75G-3/8GP ROTARY PUMP
Part Number	H75G-3/8VP	H75G-3/8GP
Maximum Distance, ft	75'	125'
Capacity, BTU/hr evap 20f	3200	
Glycol tank capacity, gal	5.5	5.5
Voltage, Volt/Hz	115/60	
Dedicated Circuit, amp	15	
Compressor Power, hp	3/8	
Pump Type	FloJet SPC42	80gal/hr
Optional Additional Pump	n/a	
Thermostat	Digital	
Refrigerant	R134a	
Legs (Sold Separately)	6"	
Dimensions W x D x H , in	17x15x30	17x15x31
Weight Gross/Net, lbs	93/83	102/92



H75G-3/8GP
(Rotary Vane Pump)



H75G-3/8VP
(Vertical Pump)

Product Features

- Efficient R134a refrigerant
- Compact size
- All metal robust construction

BEER AND BEVERAGE COOLING SYSTEMS GLYCOL POWER PACKS



- Vertical or horizontal body for better use of available space
- Digital thermostats on all models
- Optional 6" legs



G30-3/8GP
(Rotary Vane Pump)

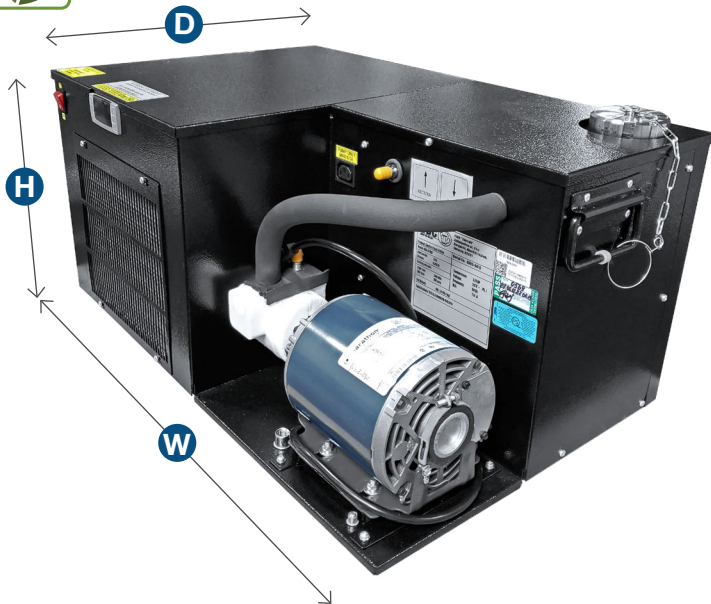

NOTE: This Glycol Deck unit has a sealed bath

Glycol Power Packs

Name	G30-3/8GP ROTARY PUMP
Part Number	G30-3/8GP
Maximum Distance, ft	125'
Capacity, BTU/hr evap 20f	2600
Glycol tank capacity, gal	2.9
Voltage, Volt/Hz	115V/60
Dedicated Circuit, amp	15
Compressor Power, hp	3/8
Pump Type	50-100 gal/hr
Pumps	1
Pump Capacity, GPH	50
Thermostat	Digital
Refrigerant	R134a
Legs (Sold Separately)	6"
Dimensions W x D x H, in	27x19x13
Weight Gross/Net, lbs	111/101

Glycol Accessories

SKU	Description
GL-1G	Propylene Glycol, 1 Gallon
GLD	Propylene Glycol, 53 Gallon Drum
TL101	Refractometer
P106	Legs for Glycol Chillers
TRT3/8-2	Recirculation bundle, 3/8" ID, 2 lines, 1 Foot
FIT2	Tape, 2" Foam Insulation, 30'
FT9019	3/8" Hose U-bend
FT9005	3/8" Elbow Hose Splicer



FIT2



GL-1G



TRT3/8-2



FT9005



FT9019



TL101

BEER AND BEVERAGE COOLING SYSTEMS

GLYCOL POWER PACKS

- Vertical or horizontal body for a better use of available space
- Digital thermostats on all models
- Optional 6" legs



Glycol Power Packs

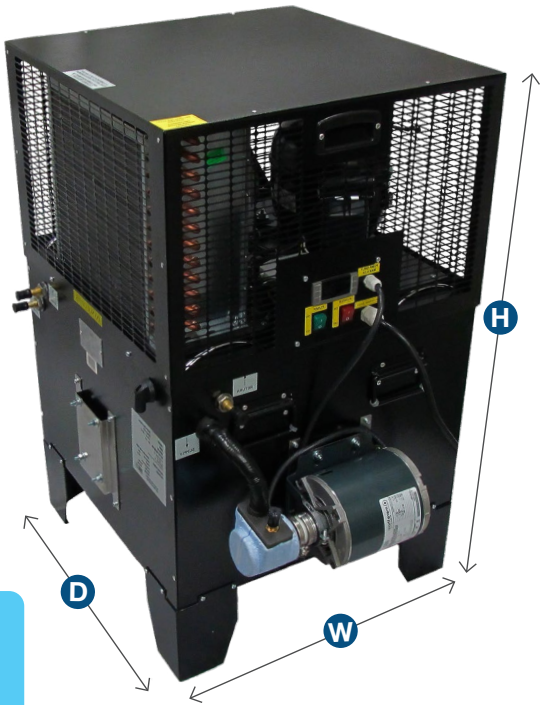

Name	EXTRA 1/2 GP		EXTRA 3/4 GP	
Part Number	EG-1/2P	EG-1/2P-ASM (2 pumps)	EG-3/4P	EG-3/4P-ASM (2 pumps)
Maximum Distance, ft	250'	250'	450'	450'
Capacity, BTU/hr evap 20f	2900	2900	5500	5500
Glycol tank capacity, gal	18			
Voltage, Volt/Hz	115/60			
Dedicated Circuit, amp	20			
Compressor Power, hp	1/2		3/4	
Pump Type	80gal/hr			
Pumps	1	2	1	2
Pump Capacity, GPH	80	160	80	160
Thermostat	Digital			
Refrigerant	R134a			
Legs	6"			
Dimensions W x D x H , in	28x23x30			
Weight Gross/Net, lbs	149/141		172/155	



EXTRA 1/2GP
(Rotary Vane Pump)

Optional
Second Pump

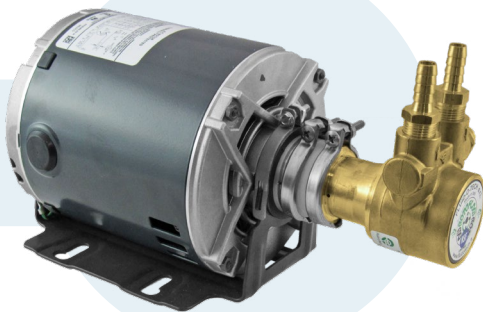

EXTRA 3/4GP
(Rotary Vane Pump)

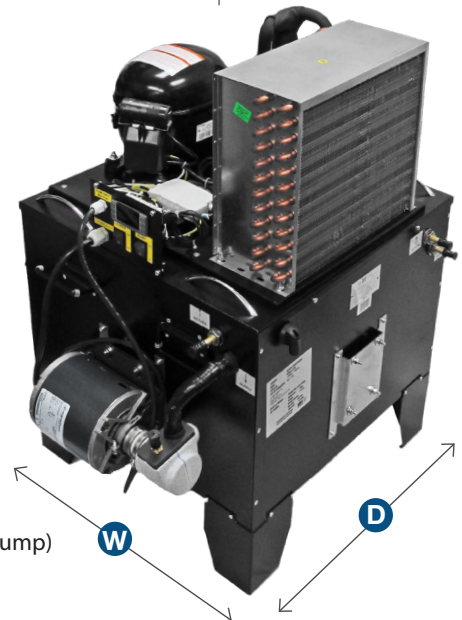

BEER AND BEVERAGE COOLING SYSTEMS

GLYCOL POWER PACKS



- Vertical or horizontal body for a better use of available space
- Stainless Steel finish "Brewery Series" glycol chillers
- Operation distance up to 750 ft
- Digital thermostats on all models
- Optional 6" legs

Glycol Power Packs

Name	EXTRA 1.5P	EXTRA 1.5P WATER COOLED
Part Number	EG-1.5-2P (Brewery Series) EG-1.5SS-2P	EG-1.5-2PWC (Brewery Series) EG-1.5SS-2PWC
Maximum Distance, ft	750'	
Capacity, BTU/hr evap 20f	10800	9900
Glycol tank capacity, gal	18	
Voltage, Volt/Hz	220/60	220/60
Dedicated Circuit, amp	20	20
Compressor Power, hp	1 ½	
Pump Type	80gal/hr	
Pumps	2	
Optional Additional Pumps	2	
Thermostat	Digital	
Refrigerant	R404a	
Legs	6"	
Dimensions W x D x H , in	29x23x28	29x23x32
Weight Gross/Net, lbs	235/187	205/193

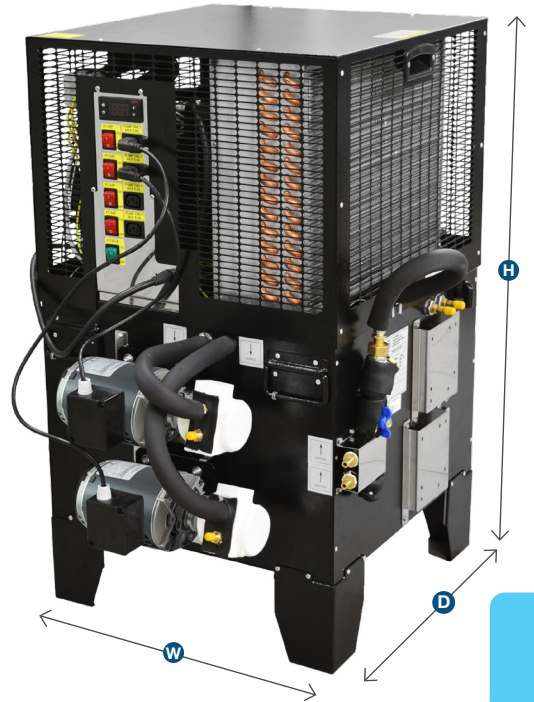

EXTRA 1.5P
(Rotary Vane Pump)

Stainless steel body
"Brewery Series"



Optional
Third and Fourth
Pump

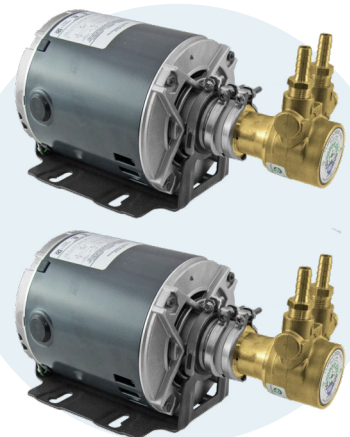

DRAUGHT BEER ICE BANK FLASH COOLERS

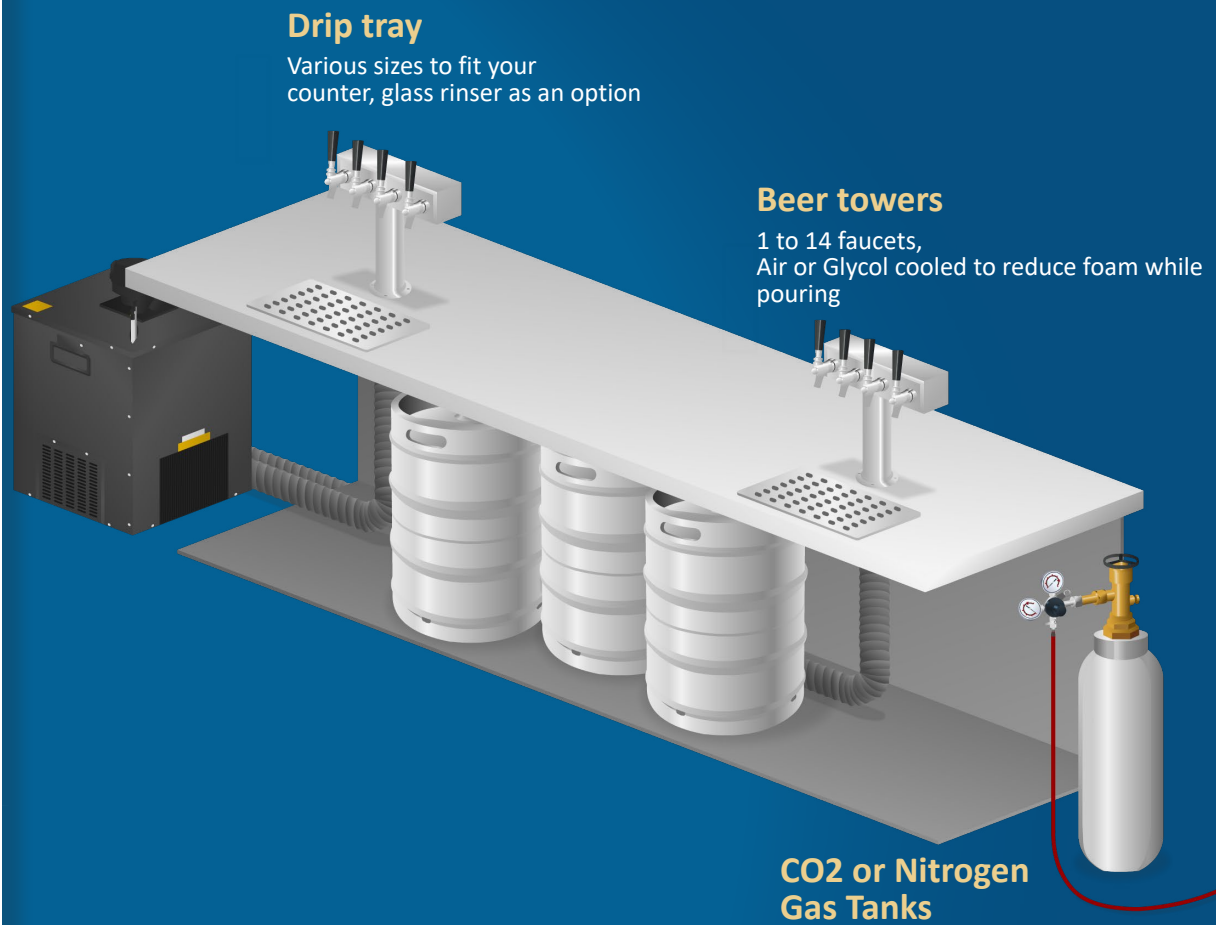

Draught Beer Ice Bank Flash Coolers

- Suitable for beer, beverages or wine
- Easy-to-install chillers ideal for mobile and special event solutions
- Can be added to an existing remote glycol system for additional cooling capacity
- Highest climate class - class 4 (outdoor use)

DRAUGHT BEER ICE BANK / FLASH COOLERS

FLASH COOLERS



- Suitable for cooling and dispensing beer, beverages or wine
- Can be used as a mobile solution for special events or patio events
- Can be added to a remote glycol system for additional cooling capacity

Flash Coolers

Name	Sputnik 1/6	Sputnik 1/4
Part Number	SPUTNIK-1/6	SPUTNIK-1/4
Capacity, l/h ($\Delta T = 28^\circ F$)	20	50
Dedicated Circuit, amp	2.8	15
Voltage, V/Hz	115 V / 60Hz	
Compressor Power, HP	1/6	1/4
Power consumption, Wt	350	416
Operating amperage, A	2.8	5.9
Refrigerant	R134a	
Ready time ($T_{amb}=75^\circ F$), min	15	25
Outlet temperature, $^\circ F$	35.6 - 42.8	
Number of Product Lines, Coils	1	2
Operating ambient temperature, $^\circ F$	75	
Power cord length, ft	6.6	
Dimensions W x D x H , in	8x16x15	15x15x17
Net Weight, lbs	58/68	94.4



Flash Coolers

Name	Kalinka 2
Part Number	KF-1/6T2
Maximum Distance, Ft	N25'
Capacity-Compressor (evap 20F), BTU/hr	1150
Capacity-Ice Bank, BTU/hr	924
Ice bank, Lbs	6.6
Dedicated Circuit, Amp	15
Voltage, Volt/Hz	115/60
Power consumption, Watt	300
Compressor Power, HP	1/6hp
Thermostat, Type	Digital
Number of Product Lines, Coils	2
Coil Diameter, ID-OD, In	1/4" -5/16"
Coil Length (total), Ft	30
Pump Type	MID-5
Pump Flow rate, Gal/Hr (water)	95
Refrigerant, Type	R134a
Dimensions W x D x H , in	18x22x12.3
Weight Net/Gross, Lbs	50/56



SPUTNIK 1/6
1 product line



SPUTNIK 1/4
2 product lines



DRAUGHT BEER ICE BANK / FLASH COOLERS

FLASH COOLERS

- Suitable for cooling and dispensing beer, beverages or wine
- Can be used as a mobile solution for special events or patio events
- Can be added to a remote glycol system for additional cooling capacity



TAYFUN T120F
4 product lines



Flash Coolers

Name	Tayfun T75F	Tayfun T120F	Tayfun T160F
Part Number	T75F-1/4T3	T120F-1/3T4	T160F-1/2T6
Maximum Distance, Ft	25'		
Capacity-Compressor (evap 20F), BTU/hr	1900	2600	3100
Capacity-Ice Bank, BTU/hr	3100	5500	7500
Ice bank, Lbs	21	35.2	52.9
Dedicated Circuit, Amp	15		
Voltage, Volt/Hz	115V / 60Hz		
Power consumption, Watt	550	750	800
Compressor Power, HP	1/4hp	1/3hp	1/2hp
Thermostat, Type	Manual		
Number of Product Lines, Coils	3	4	6
Coil Diameter, ID-OD, In	1/4" -5/16"		
Coil Length (total), Ft	120	200	350
Pump Type	FloJet SPC42		
Pump Flow rate, Gal/Hr (water)	240		
Refrigerant, Type	R134a		
Dimensions W x D x H, in	14x15x29	17x18x31	32x19x23
Weight Net/Gross, Lbs	75/84	97/106	125/136



TAYFUN T75F
3 product lines



TAYFUN T160F
6 product lines

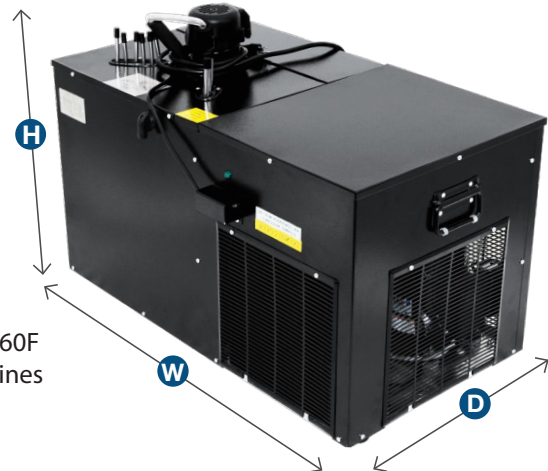

DRAUGHT BEER ICE BANK / FLASH COOLERS

FLASH COOLERS

- Suitable for cooling and dispensing beer, beverages or wine
- Can be used as a mobile solution for special events or patio events
- Can be added to a remote glycol system for additional cooling capacity

Flash Coolers

Name	Tayfun T220F
Part Number	T220F-1/2T14
Maximum Distance, Ft	25'
Capacity-Compressor (evap 20F), BTU/hr	4500
Capacity-Ice Bank, BTU/hr	9000
Ice bank, Lbs	57.3
Dedicated Circuit, Amp	15
Voltage, Volt/Hz	115V / 60Hz
Compressor Power, HP	1/2hp
Thermostat, Type	Manual
Number of product lines, coils	14
Coil Diameter, ID-OD, In	1/4" - 5/16"
Coil Length (total), Ft	420
Pump Type	FloJet SPC51
Pump Flow rate, Gal/Hr (water)	240
Refrigerant, Type	R134a
Dimensions W x D x H , in	22x24x35
Weight Gross/Net, Lbs	145/162



TAYFUN V200E
2 product lines
(tower sold separately)



Flash Coolers

Name	Tayfun V-200E	Tayfun V-400
Part Number	V-200E	V-400
Capacity, BTU (AT = 30°F)	5,300	5,200
Water Tank volume, Gal	16.75	31
Water Pump capacity, GPH/PSIG	250/10	
Operating amperage, A	10A	20A
Voltage, Volt/Hz	115V / 60Hz	
Compressor Power, HP	1/2hp	2 x 1/3hp
Ice bank, lbs	65	120
Ice forming time (Tamb=75°F), h	5	6
Number of product lines, coils	1, 2, 3, 4, or 6	3
Coil Diameter, mm	Ø 8.0	
Outlet temperature, °F	38-46	
Operating ambient temperature, °F	75-90	
Refrigerant, Type	R134a	R290
Dimensions W x D x H , in	22x22x41	26x27x39
Net Weight, lbs	153	205



TAYFUN T220
14 product lines

BEVERAGE DISPENSERS, COOLING & EQUIPMENT



Beverage Dispensers, Coolers & Equipment

UBC line of portable and remote coolers and accessories for post-mix beverage dispensing systems, juice and tea dispensers, filtered carbonated water systems and for other bag-in-box beverages.

- **Counter Electric** Post-Mix Dispensers 71
- **Ice Cooled Drop-in** Post-Mix Dispensers .. 75
- **Epoque** Touchscreen Dispensing Tower ... 77
- **Beverage and Carbonator** Coolers 78
- **Beverage System** Parts 79

BEVERAGE COOLING AND DISPENSING

COUNTER ELECTRIC POST-MIX DISPENSERS

- Stainless steel cabinet, product lines, and built in drip tray
- R290 Refrigerant
- Available for 2, 4, 6, or 8 products

Counter Electric Post-Mix Dispensers

Name	CarboMix 6	CarboMix 6 Plus
Part Number	CM6-1/4	CMP6-1/4
Number of Valves, pcs		6
Ice bank, lbs		29
Ice bank forming time, hours		6
Draw performance, drinks (355 ml (12oz), 2 drinks/min, ≤40°F, 75 °F ambient temperature)		220
Product outlet temperature, °F		37-40
Operating ambient temperature, °F		75
Tank volume, gal		9.2
Refrigerant		R290
Voltage, Volt/Hz		115V / 60hz
Power Cord Length, ft		3.2
Current, A		4.5
Dimensions W x D x H , In		18x28x27
Weight Gross/Net, Lbs		147.7



NEW

CARBOMIX 6

Product Features

- Stainless steel cabinet, product lines, and built in drip tray
- CFC free, GREEN R290 or conventional R134a refrigerant
- Available for 2, 4, 6, or 8 products
- High quality post-mix dispensing valves
- All valves can be serviced individually
- Removable refrigeration deck
- Optional LED illuminated branding
- Optional legs

Complementary Products



Carbonators
Page 73

Bag-in-Box Rack
Page 75

BEVERAGE COOLING AND DISPENSING

ICE COOLED DROP-IN POST-MIX DISPENSERS

- Heavy-duty stainless construction with built-in sealed cold plate and drainage
- Available for 2, 4, 6 or 8 products



ICEBERG 6

NEW

Ice Cooled Drop-In Post-Mix Dispensers

Name	IceBerg 6
Part Number	ICB-6
Number of Valves, pcs	6
Ice Tank Volume, gal	10
Operating Ambient Temperature, °F	60-90
Product Outlet Temperature, °F	39-46
Draw Performance, drinks (355 ml (12oz), 2 drinks/min, ≤40°F, 75 °F ambient temperature)	80
Countertop Cut Out, W x D	15 3/8" x 23 1/4"
Pressure of supplied water / syrups, bar	4.2
Voltage, V/Hz	115V / 60Hz
Current, A	1.5 Amp
Power cord length, ft	9.8
Dimensions W x D x H , In	18.3 x 25.3 x 38.1
Weight Gross/Net, Lbs	161.9

Complementary Products



Carbonators
Page 73

Product Features

- Heavy duty stainless construction with built-in sealed cold plate, and drainage
- CFC free, ice bin insulated with structural foam
- Available for 2, 4, 6, or 8 products
- High quality post-mix dispensing valves with lever or push button dispensing versatility
- Tower with a removable splash plate and drip tray for easy cleaning
- Optional LED illuminated branding

Bag-in-Box Rack
Page 75



BEVERAGE COOLING AND DISPENSING

TOUCHSCREEN DISPENSING TOWER

- Large 10" touchscreen control
- Countertop installation with a small footprint
- Up to 8 valves dispensing carbonated and non-carbonated beverages



EPOQUE

NEW

Product Description

The Epoque touchscreen tower is an attractive, illuminated touch screen dispensing tower to dispense soda, teas and juices - any carbonated or non-carbonated beverage. With up to 8 valve modules, this tower offers the flexibility to add new drinks and its user-friendly interface allows customers to enjoy their personal preferences in an interactive, modern experience.

Epoque Dispensing Tower

Name	Epoque
Part Number	EPQ6
Product Inlets	6 syrups + 2 (water / soda)
Electrical Requirements	24V
Product Connections	3/8"
Screen Type	Touch
Screen Size	7"
Flow Rate	1.8 oz/sec
Dimensions W D H	8x12x23
Weight Net, Lbs/kg	33 / 15

Complementary Products



Carbonators
Page 73



Bag-in-Box Rack
Page 75

BEVERAGE COOLING AND DISPENSING

BEVERAGE AND CARBONATOR COOLERS

- Portable cooling and carbonation of water and soft drinks
- Remote cooling and carbonation of bag-in-box drinks

CARBO-CHILL 60V

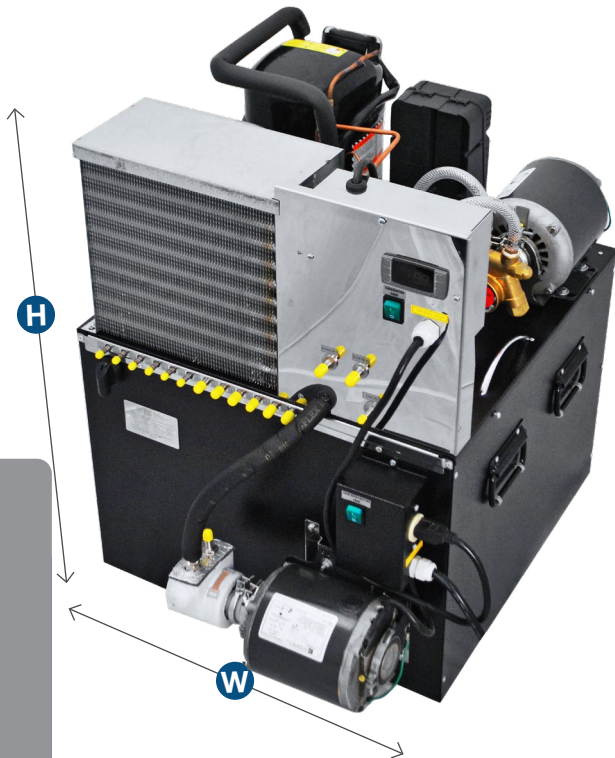

Name	Carbo-Chill 15	Carbo-Chill 60V
Part Number	CCV15-1/4T2	CCV60-1/2T6
Built-in Carbonator	YES	YES
Maximum Distance, Ft	N/A	150"
Capacity-Compressor (evap 20F), BTU/hr	1500	3900
Capacity-Ice Bank, BTU/hr	1400	6300
Ice bank, Lbs	10	45
Dedicated Circuit, Amp	15	20
Voltage, Volt/Hz	115V/60Hz	
Power consumption, Watt	450	800
Compressor Power, HP	1/4	1/2
Thermostat, Type	Digital	Digital
Number of product lines, coils	2	6
Coil Diameter, ID-OD, In	1/4"-5/16"	
Pump Type	Agitator	Gear
Pump Flow rate, Gal/Hr (water)	95	100
Refrigerant, Type	R134a	
Dimensions W x D x H , In	14x19x18	18x24x29
Weight Gross/Net, Lbs	85/80	185/175

Complementary Product

- Designed for carbonated and non-carbonated beverages
- Operational touchscreen
- 2-8 products
- Made in Europe

Epoque Tower



BEVERAGE COOLING AND DISPENSING BEVERAGE SYSTEM PARTS

- Parts and accessories for remote bag-in-box systems
- Portable bottle water dispensers
- Parts for drop-in ice bin coolers



CARB-400397

Carbonators

SKU	Description
BP16-1404	Carbonator, Replacement Probe Assembly
CARB-436002	Carbonator, Standard, McCann
CARB-400397	Carbonator, BigMac, McCann

FloJet Pumps

SKU	Description
PV42	Vertical Agitator Pump, FloJet SPC42
BPP5000-130	Syrup pump, FLOJET
BPP01500-030A	Transfer Valve, Regular
PG56	Beer pump, FLOJET

Pump Fittings

SKU	Description
BPF001	Brass 1/4" elbow hose barb inlet with shut-off
BPF002	Brass 1/4" "T" hose barb inlet with shut-off
BPF003	Brass 1/4" strait hose barb inlet with shut-off

In-line Regulators

SKU	Description
DTP01752-327C	In-line Water Pressure Regulator, 30 psi
DTP01752-307C	In-line Water Pressure Regulator, 50 psi, 3/8" Barb
DTP01750-301C	In-line Water Pressure Regulator, 50 psi, 1/4" Barb



CARB-436002



BP16-1404



PV42



BPP5000-130



BPP01500-030A



PG56



BPF001

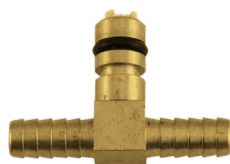

BPF002



DTP01752-327C



DTP01752-307C

BEVERAGE COOLING AND DISPENSING

BEVERAGE SYSTEM PARTS

- Parts and accessories for remote bag-in-box systems
- Portable bottle water dispensers
- Parts for drop-in ice bin coolers



FHV3NN



TW1812100

Water Filtration

SKU	Description
FHV3NN	3-stage water filtration system, 0.3 Gpm, removes chlorine and by-products, ECOSOFT
CHV3ECOEXP	Replaceable filter pack for 3-stage water filters, ECOSOFT
ROBUSTEN	Reverse osmosis water filtration system, 0.3 Gpm, removes total dissolved solids, nitrates, chlorides, sulfates, hydrocarbonates and hardness, ECOSOFT ROBUST
TW1812100	Membrane, ECOSOFT ROBUST



BPC001



BPC002



BPC003

Connectors

SKU	Description
BPC001	Liqui-box QCD II Bag-in-Box connector
BPC002	CC Bag-in-Box connector
BPC003	Ball lock GAS quick disconnect, 1/4" barb
BPC004	Ball lock LIQUID quick disconnect, 1/4" barb
BPC005	Pin lock GAS quick disconnect, 1/4" barb
BPC006	Pin lock LIQUID quick disconnect, 1/4" barb
BPP007	Swivel Set, 1/4" ffl Nut and 5/16" Barb
BPP008	Swivel Set, 1/4" ffl Nut and 3/8" Barb



BPC004



BPC005



BPC006

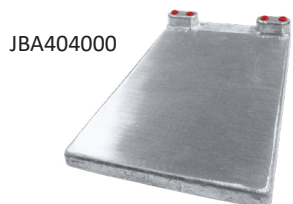

JBA404000

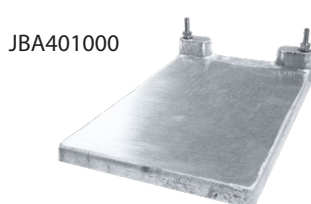

JBA401000

Cold Plates

SKU	Description
JBA401000	8" x 12", 1 Product, 1/4" Barb
JBA402000	8" x 12", 2 Products, 1/4" Barb
JBA404000	10" x 15", 2 Products, 1/4" Barb
JBA404003	8" x 14", 3 Products, 1/4" Barb
JBA404008	8" x 14", 8 Products, 1/4" Barb



RK2-BIFJG

Bottle Water Dispensers

SKU	Description
BWD1000A	FloJet single inlet bottle water dispenser
BWD2000A	FloJet double inlet bottle water dispenser



Bag-in-Box Rack

SKU	Description
RK2-BIFJG	2-box inclined shelf

WINE-ON-TAP SYSTEMS

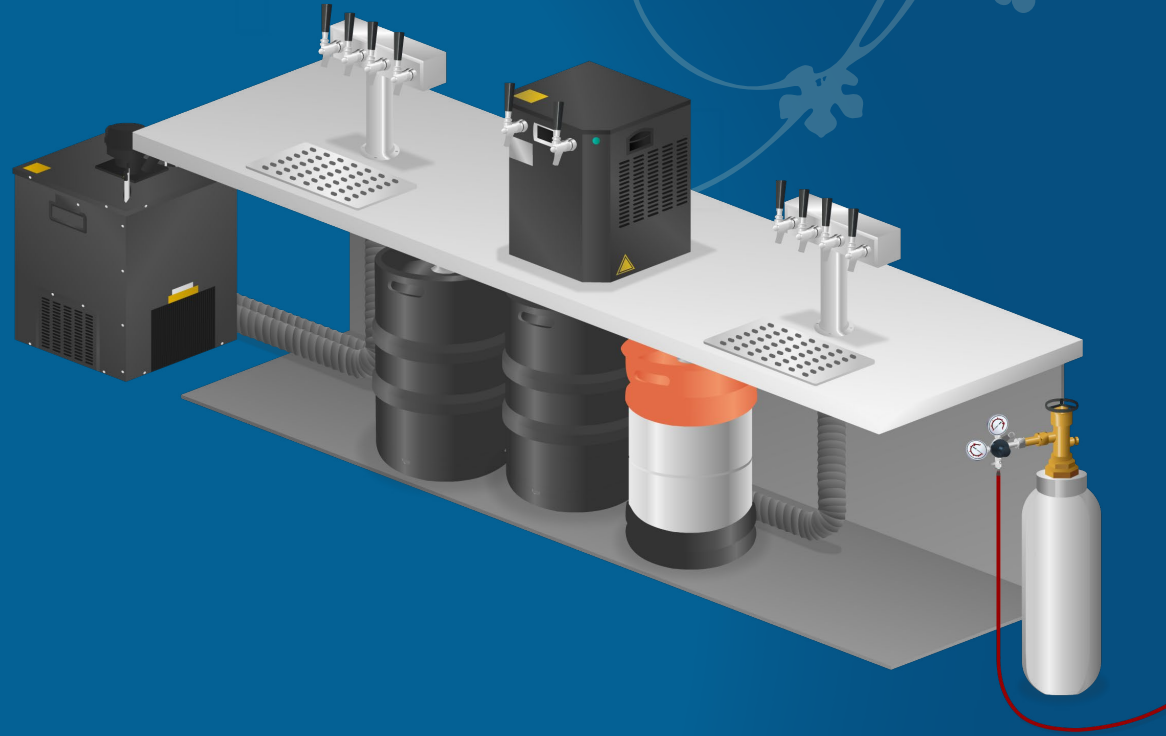

Wine-On-Tap System

Wine-on-tap means a perfect pour, every time, for any length of time. Exactly the way the winemaker intended.

- An inert gas pushes the wine out of the keg, preserving the wine remaining in the keg for months.
- Wine will not oxidize and will never be corked or experience bottle variation or any other flaws due to packaging.

WINE-ON-TAP SYSTEMS

WINE-ON-TAP COOLERS

- Easy-to-install coolers ideal for wine-on-tap dispense
- 316 Stainless Steel product lines suitable for wine dispensing
- Digital thermostat



TAYFUN T120F
4 product lines



TAYFUN T75F
3 product lines

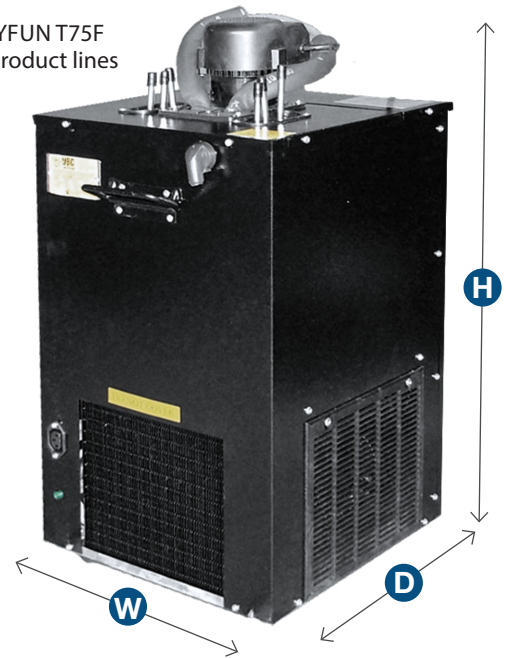

KALINKA 2

Name	Kalinka 2	Tayfun T75F	Tayfun T120F
Part Number	KF-1/6T2	T75F-1/4T3	T120F-1/3T4
Maximum Distance, Ft	25'	25'	v25'
Capacity-Compressor (evap 20F), BTU/hr	1150	1900	2600
Capacity-Ice Bank, BTU/hr	924	3100	5500
Ice bank, Lbs	6.6	22	44
Dedicated Circuit, Amp	15		
Voltage, Volt/Hz	115/60		
Power consumption, Watt	300	550	750
Compressor Power, HP	1/7+hp	1/4hp	1/3hp
Thermostat, Type	Digital		
Number of product lines, coils	2	3	4
Coil Diameter, ID-OD, In	1/4" -5/16"		
Coil Length (total), Ft	30	120	200
Pump Type	MID-5	FloJet SPC42	
Pump Flow rate, Gal/Hr (water)	95	240	
Refrigerant, Type	R134a		
Dimensions W x D x H , in	18x22x12.3	15x16x28	17x19x30
Weight Gross/Net, Lbs	50/56	75/84	97/106

DRAUGHT BEER DISPENSE SYSTEM COMPONENTS



Draught Beer Dispense System Components

■ Primary Regulators	84
■ Secondary Regulators	85
■ Regulator Parts	86
■ Gas Blenders	88
■ Regulator Panels.....	89
■ Pumps & Motors	91
■ Keys	92
■ Kege Accessories	93
■ Kege Couplers & Parts	94
■ Draught Beer System Parts.....	97
■ John Guest Fittings	98
■ Fittings	101
■ Trunkline and Tubing.....	103

DRAUGHT BEER DISPENSE SYSTEM COMPONENTS

PRIMARY REGULATORS

- Full line of Domestic and European regulators
- Various options for type of regulators



Primary CO₂ Regulators - 60psi

SKU	Description
RGC-T2	Primary CO ₂ , 60psi, TapRite
RGC-T2HP	Primary CO ₂ , 160psi, TapRite
RGCM-60	Primary CO ₂ 60psi, MicroMatic

Primary Nitrogen Regulators

SKU	Description
RGN-T2	Primary N ₂ , 60psi, TapRite
RGN-T2HP	Primary N ₂ , 160psi, TapRite
RGNM-60	Primary N ₂ , 60psi, MicroMatic
RGN-942BN	Primary N ₂ , 120psi, MicroMatic

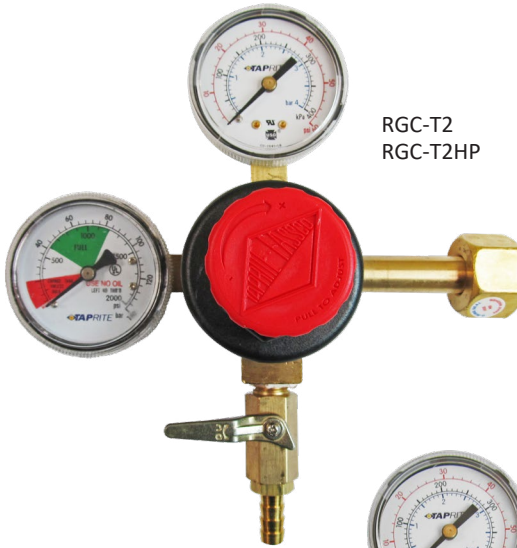

RGC-T2
RGC-T2HP

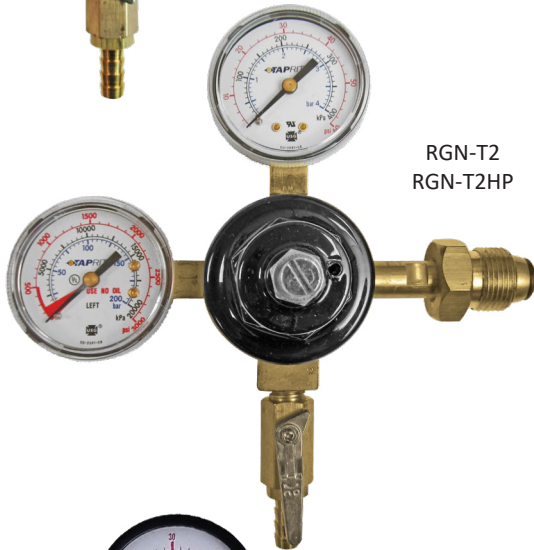

RGN-T2
RGN-T2HP



RGNM-60

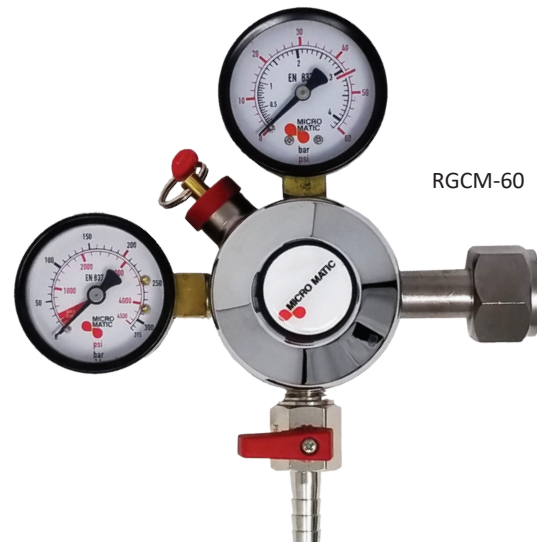

RGCM-60

DRAUGHT BEER DISPENSE SYSTEM COMPONENTS SECONDARY GAS REGULATORS

- Complete line of primary and secondary gas regulators
- Regulator parts and components

Secondary Regulators

SKU		Description
TapRite	MicroMatic	
RGST-1PB	RGSM-1PB	Secondary, 1 product, plug-barb
RGST-1BB	RGSM-1BB	Secondary, 1 product, barb-barb
RGST-1BP	RGSM-1BP	Secondary, 1 product, barb-plug
RGST-1BB2	-	Secondary, 1 product, 2 shut-offs, barb-barb
RGST-2PB	RGSM-2PB	Secondary, 2 product, plug-barb
RGST-2BB	RGSM-2BB	Secondary, 2 product, barb-barb
RGST-2PB	RGSM-2BP	Secondary, 2 product, barb-plug
RGST-3PB	RGSM-3PB	Secondary, 3 products, plug-barb
RGST-3BB	RGSM-3BB	Secondary, 3 product, barb-barb
RGST-3PB	RGSM-3BP	Secondary, 3 product, barb-plug
RGST-4PB	RGSM-4PB	Secondary, 4 products, plug-barb
RGST-4BB	RGSM-4BB	Secondary, 4 products, barb-barb
RGST-4PB	RGSM-4BP	Secondary, 4 products, barb-plug
RGST-5PB	RGSM-5PB	Secondary, 5 products, plug-barb
RGST-5BB	RGSM-5BB	Secondary, 5 products, barb-barb
RGST-5PB	RGSM-5BP	Secondary, 5 products, barb-plug

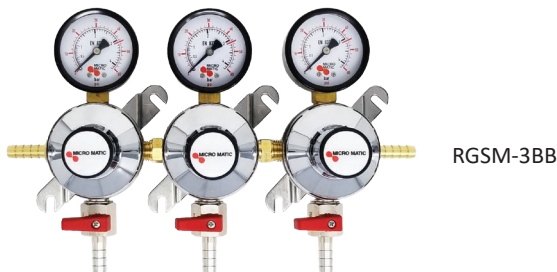

Regulator Fittings

SKU	Description
RGPCO2-N	CO ₂ bottle to N ₂ regulator adapter
RGPN-CO2	N ₂ bottle to CO ₂ regulator adapter
RGP-COV	CO ₂ changeover valve

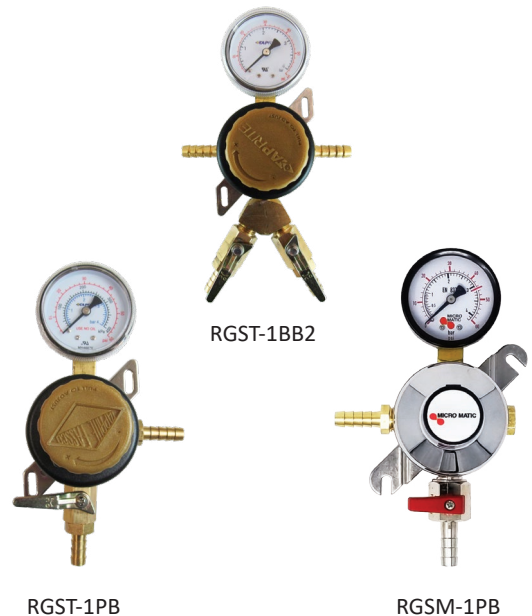

DRAUGHT BEER DISPENSE SYSTEM COMPONENTS

REGULATOR PARTS

- Full set of regulator parts and accessories
- Air distributor allows you to connect many different barrels from one primary regulator

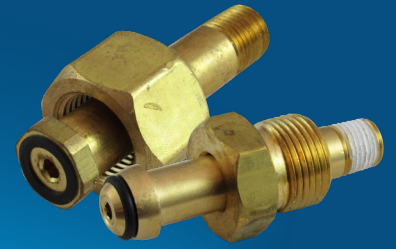

RGP294



RGP1024



RGP-P14



RGP-S2



RGP-Y14



RGP125-5B



RGP740-19



RGP740-20



RGP121-BL



RGP121-B



RGPCO2-N

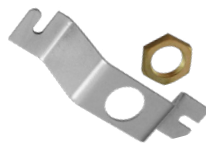

RGP-MB



RGP6400P



RGP6400S

Regulator Parts

SKU	Description
RGPN-CO2	N2 Bottle to CO2 Regulator Adapter
RGPCO2-N	CO2 Bottle to N2 Regulator Adapter
RGPCO2	CO2 Regulator Nut and Nipple
RGP740-19	CO2 Nut and Nipple with Flat Seat
RGP740-20	Nitrogen Nut and Nipple with O-Ring
RGP294	CO2 Washer, Hard Fiber
RGP125-6B	Barbed Nipple, 3/8"
RGP125-5B	Barbed Nipple, 5/16"
RGP125-4B	Barbed Nipple, 1/4"
RGP1224	N Regulator O-Ring
RGP121-BL	Hex Nipple MPT/Union 1/4", Left Hand Thread
RGP121-B	Hex Nipple MPT/Union 1/4"
RGP1024	CO2 Rubber Seal, TapRite
RGP-Y14	Regulator Y Fitting 1/4"
RGP-S2	Safety Valve
RGP-P14	Plug 1/4"
RGP-MB	Mounting Bracket for Micromatic

Regulator Repair Kits

SKU	Description
RGP7740-15	Repair Kit for CO2 and Secondary, TapRite
RGP7740-15N	Repair Kit for N, TapRite
RGP6400-P	Repair Kit for Primary Premium Regulator, Micromatic
RGP6400-S	Repair Kit for Secondary Premium Regulator, Micromatic

DRAUGHT BEER DISPENSE SYSTEM COMPONENTS

REGULATOR PARTS

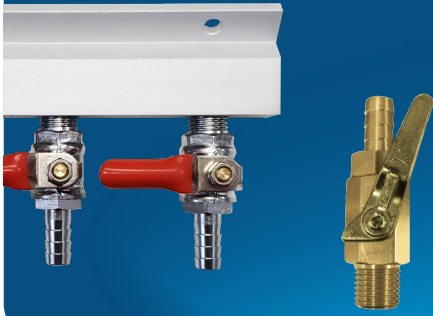

- Air Distributors in various sizes
- Regulator parts and components

Regulator Gauges

SKU	Description
RGP740-502	60lbs Regulator Gauge
RGP740-503	160lbs Regulator Gauge
RGP6003-3000R	3000lbs Regulator Gauge, Righthand Thread
RGP6003-3000L	3000lbs Regulator Gauge, Lefthand Thread



RGP740-502



RGP-RGG

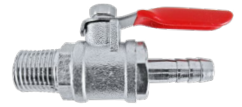

RGP1600C14



RGP1600CA



RGP1600A



RGP6003-3000L

Regulator Gauge Guards

SKU	Description
RGP-RGG	Rubber Jacket for Regulator Gauge
RGP-TAPGG	Gauge Guard for TapRite Regulator
RGP-MMGG	S/S Gauge Guard for MicroMatic Regulator



RGP-MMGG



RGP-TAPGG

Regulator Shut-Offs

SKU	Description
RGP1600NC3/8	Shut-off Valve, 3/8" Barb, No Check Valve, Metal Knob
RGP1600NC	Shut-off Valve, 5/16" Barb, No Check Valve, Metal Knob
RGP1600CA	Shut-off Valve with Ball Check, 5/16" Barb, Metal Knob, TapRite
RGP1600C14	Shut-off Valve, 1/4" Barb, Check Valve, Metal Knob
RGP1600C	Shut-off Valve, 5/16" Barb, Check Valve, Metal Knob
RGP1600A	Shut-off Valve, 5/16" Barb, Check Valve, Taprite

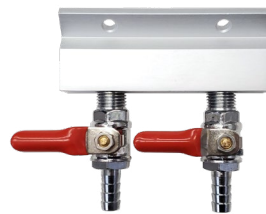

AD1742



AD1743

Air Distributors

SKU	Description
AD1742	Two-way Air Distributor
AD1743	Three-way Air Distributor
AD1744	Four-way Air Distributor
AD1745	Five-way Air Distributor



AD1744

Standard manifold block comes with shut-off valves only. Safety valves, plugs and barbed nipples are ordered separately.

DRAUGHT BEER DISPENSE SYSTEM COMPONENTS

GAS BLENDERS

- Specially designed to fill the needs of the Canadian and U.S. beer dispensing market
- McDantum blending panels include gauges to adjust pressure

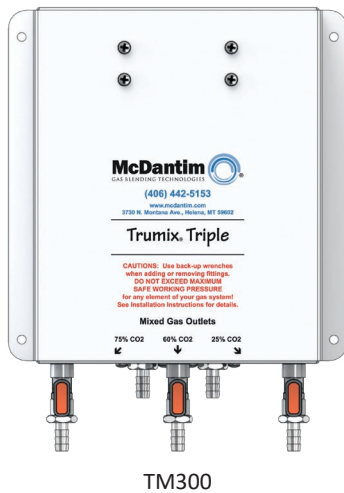

McDantum Trumix™ Blending Panel

The McDantum Trumix™ Blending Panel was specifically designed to fill the needs of the U.S. Beer Dispensing Market. The Panel is a small wall-mounted unit that tucks neatly and safely out of the way. It is easy to install and is extremely dependable. The Trumix™ requires no electricity, on-going maintenance or adjustment. It can be used equally well with all sources of clean nitrogen and CO2 including high pressure cylinders, bulk tanks or separators.

McDantum blending panels include gauges to adjust pressure.

SKU	Description
TM100	Single Outlet Blending Panel, up to 15 kegs/hr
TM100HF	Single Outlet Blending Panel, up to 30 kegs/hr
TM200	Double Outlet Blending Panel, up to 30 kegs/hr
TM200HF	Double Outlet Blending Panel, up to 60 kegs/hr
TM300	Triple Outlet Blending Panel
MV013	1/4" T w/Check Valve

In-line leak indicator

With McDantum's In-Line Leak Indicator (MV035), you can see within seconds if you have a leak and gauge how big that leak is.

SKU	Description
MV035	Double In-line leak indicator
MV039	Single In-line leak indicator

DRAUGHT BEER DISPENSE SYSTEM COMPONENTS

REGULATOR PANELS

- Secondary gas regulators, FOBs and beer pumps mounted on a metal panel for easy installation on the walk-in cooler interior wall
- Available custom assembled



Regulator Panels

SKU	Description
BP-S2	Secondary Panel with 2 Secondary Regulators
BP-SF1	Secondary Panel with 1 Secondary Regulator and 1 FOB, 3/8" ID Tubing
BP-SF2	Secondary Panel with 2 Secondary Regulators and 2 FOBs, 3/8" ID Tubing
BP-SF3	Secondary Panel with 3 Secondary Regulators and 3 FOBs, 3/8" ID Tubing
BP-SF4	Secondary Panel with 4 Secondary Regulators and 4 FOBs, 3/8" ID Tubing
BP-SF5	Secondary Panel with 1 Secondary Regulator and 2 FOBs
BP-SF6	Secondary Panel with 2 Secondary Regulators and 2 FOBs, 3/16" ID Tubing
BP-SF7	Secondary Panel with 2 Secondary Regulators and 2 FOBs, 3/8" ID Tubing, PP

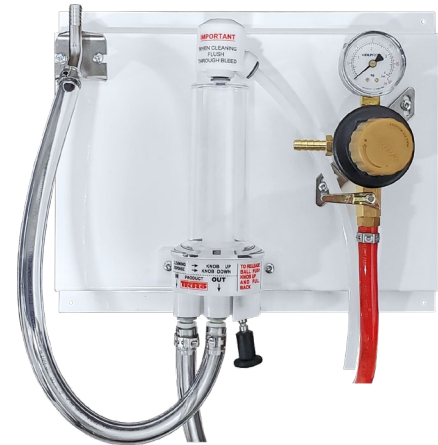

All Regulator Panels come standard with 6ft. Beer Line, 3/8" Tail Piece and Swivel Hex Nut and 6ft. Gas Line.

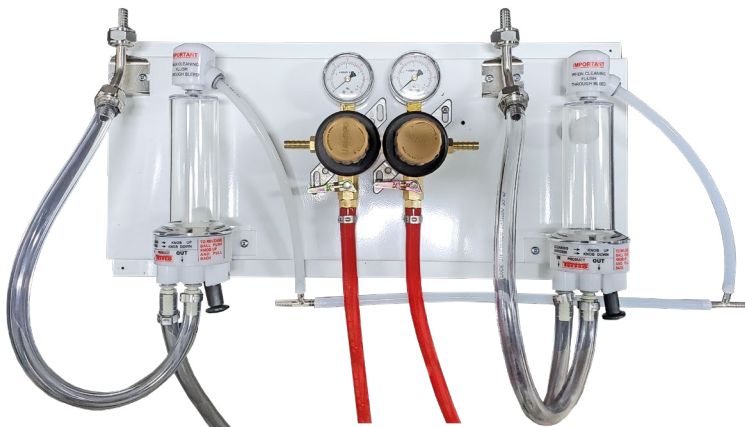

BP-SF2

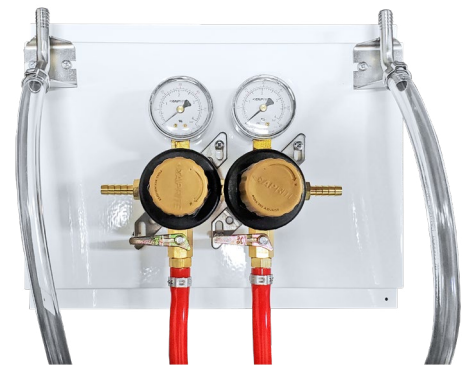

BP-SF6



BP-SF4

DRAUGHT BEER DISPENSE SYSTEM COMPONENTS

REGULATOR PANELS

- Secondary gas regulators, FOBs and beer pumps mounted on a metal panel for easy installation on the walk-in cooler interior wall
- Available custom assembled



Custom Panel Options

FOBs:

Choose from 3 different FOB options:

- FOB (3/8" OD Bleed Valve)
- FOB2, Classic (3/16" OD Bleed Valve)
- FOB3 (3/16" OD Bleed Valve)

Regulators:

Choose from 2 different regulator options:

- TapRite
- MicroMatic

Let us know of any other specifications and we will design your panel based on all your requirements!

Regulator Panels

SKU	Description
BPP-L2-EBT	Lead Pump Panel with 2 Flojet Beer Pumps, 2 Secondary Regulators, 2 Tecflo FOBs and Manifold
BPP-L2-DELUXE	Deluxe Panel with 2 Flojet Beer Pumps, 2 Secondary Regulators, 2 FOBs, Beer Manifolds, Cleaning Heads
BPP-L2-EBT-MX	Lead Pump Panel with 2 Flojet Beer Pumps, 2 Secondary Regulators, 2 Tecflo FOBs

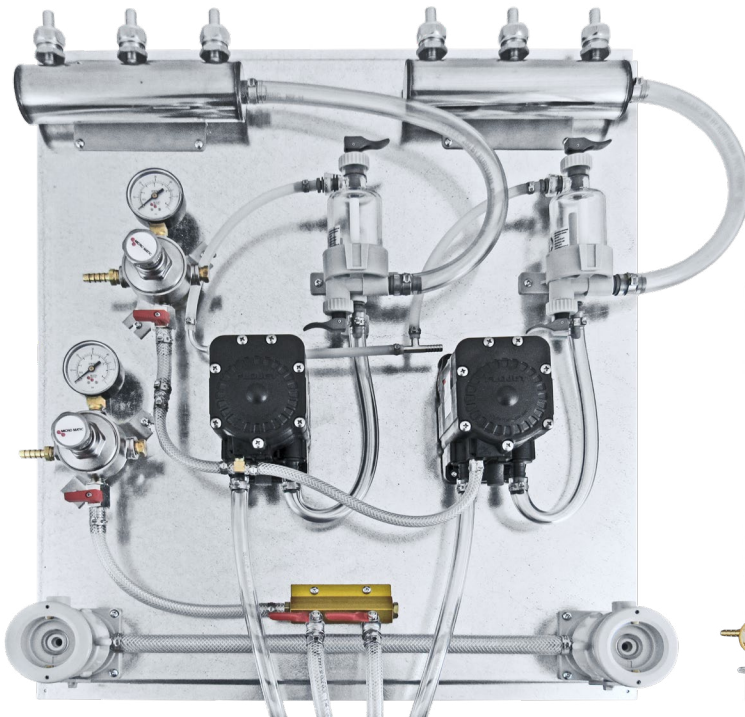

BPP-L2-DELUXE

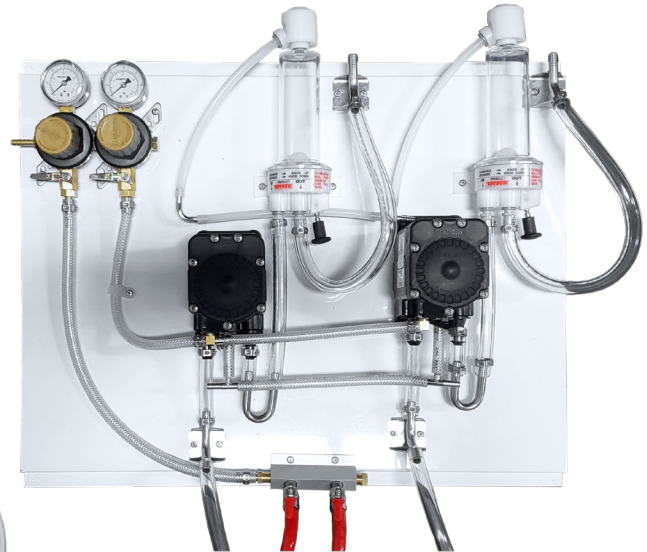

BPP-L2-EBT



BPP-L2-EBT-MX

DRAUGHT BEER DISPENSE SYSTEM COMPONENTS

PUMPS AND MOTORS



PM1-3

- Flojet Beer pumps
- Procon pumps
- Replacement pumps and motors for UBC equipment

Rotary Vane Pumps & Motors

SKU	Description
PMA-ASM	100 GPH Pump and Motor Assembly (complete with fittings and clamp)
PMA75-ASM	75 GPH Pump and Motor Assembly (complete with fittings and clamp)
PMA45-ASM	45 GPH Pump and Motor Assembly (complete with fittings and clamp)
PP100	Rotary Vane Pump, Procon/Fluid-o-tech Pump 100 GPH
PP75	Rotary Vane Pump, Procon/Fluid-o-tech Pump 75 GPH
PP45	Rotary Vane Pump, Procon/Fluid-o-tech Pump 45 GPH
PM1-3M	Pump Motor, 1/3HP
EC5W	Electric 9W Fan Motor
EC9W	Electric 9W Fan Motor
EC16W	Electric 16W Fan Motor
EC25W	Electric 25W Fan Motor

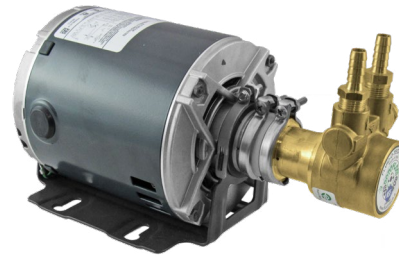

PMA-ASM



PP100



PA200

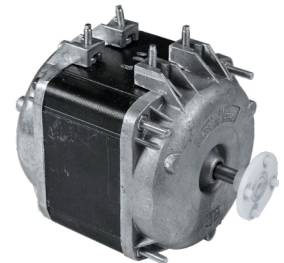

EC25W

Pump Parts

SKU	Description
PA291	Dumper Coupling
PA200	Dumper Coupling Assembly
P1113	V-Band Clamp
PAJ	Foam Pump Jacket
D125-6C	Barb Male Pipe Connector 3/8" x 3/8"



PV42



PV05

Vertical Agitator Pump

SKU	Description
PV42	Vertical Pump Flojet SPC42
PV05	Vertical Pump Saber MID-05

Beer Pump

SKU	Description
PG56	Flojet Beer Pump
PG56-100	Flojet Flow Reversal Valve



PG56



PG56-100

DRAUGHT BEER DISPENSE SYSTEM COMPONENTS

KEGS

- 304 Stainless Steel kegs
- Generic or Micromatic spears
- Stackable or non-stackable
- Available embossed, etched and branded



Schafer SUDEX Kegs

SKU	Description
KGSUD-D20	Stainless Steel Keg, Schafer SUDEX with MicroMatic D Fitting, 20L, Stackable, AISI 304
KGSUD-D30	Stainless Steel Keg, Schafer SUDEX with MicroMatic D Fitting, 30L, Stackable, AISI 304
KGSUD-D50	Stainless Steel Keg, Schafer SUDEX with MicroMatic D Fitting, 50L, Stackable, AISI 304

NEW



Stainless Steel Cask Keg

SKU	Description
KGCOR-20	304 Stainless Steel Cask Keg, 4.5 gal (20.46L)
KGCASK-40	304 Stainless Steel Cask Keg, 9 gal (40.9L)



Ball lock fittings with 1/4" barb available for gas and liquid posts on corny kegs.

Torpedo Ball Lock Cornelius Kegs

SKU	Description
KGCOR-6	304 Stainless Steel Cornelius Ball Lock Keg, Stackable, 1.5 gal (6L)
KGCOR-10	304 Stainless Steel Cornelius Ball Lock Keg, Stackable, 2.5 gal (10L)
KGCOR-19	304 Stainless Steel Cornelius Ball Lock Keg, Stackable, 5 gal (19L)

DRAUGHT BEER DISPENSE SYSTEM COMPONENTS

KEG ACCESSORIES

- Keg Accessories
- Keg Caps
- Keg Stackers
- Keg Spears and Parts



TLK-D/S



TL19A



KD3



KS-SKA



KS1B-50



KS2B-50

Keg Accessories

SKU	Description
TLK-D/S	Keg Spear Decompression Tool for D and S Valve
TLK-PT	Keg Retaining Ring, Pick Tool
TL19A	Keg Digital Scale, 100kg/220lbs
KS-SKA	Slim Keg Adapter, Black
KS1B-50	Keg Stacker, Height 1.5", 50L Keg, Black
KS2B-50	Keg Spacer, Height 6", 50L Keg, Black
KJ1/4-1/2	Keg Jacket, Insulated for 1/2 or 1/4 Barrels
KD3	Keg Dolly



CO2 valve in keg spear is colour coated to help determine the age of the spear



UBC carries both DSI and MicroMatic spears and parts. Contact us for any spear questions

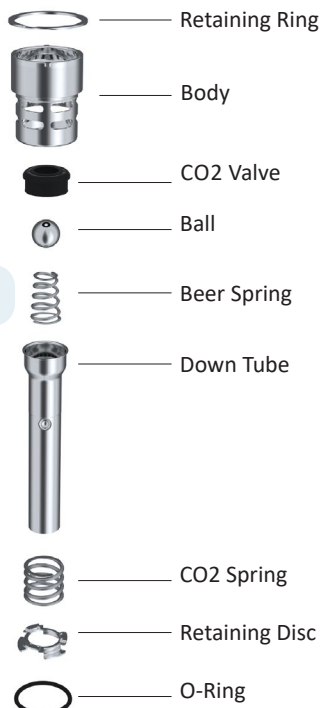

Tamper Evident Keg Caps



SKU	Description
KGC-DPULL-BLACK	Type D Keg Cap, Pull Up, No Logo, Black
KGC-DPULL-WHITE	Type D Keg Cap, Pull Up, No Logo, White
KGC-DPULL-GREEN	Type D Keg Cap, Pull Up, No Logo, Green
KGC-DPULL-RED	Type D Keg Cap, Pull Up, No Logo, Red
KGC-DPULL-BLUE	Type D Keg Cap, Pull Up, No Logo, Blue
KGC-DPULL-YELLOW	Type D Keg Cap, Pull Up, No Logo, Yellow

Dustproof Keg Caps



SKU	Description
KGC-DU-BLACK	Type D Keg Cap, No Logo, Black
KGC-DU-GREEN	Type D Keg Cap, No Logo, Green
KGC-DU-RED	Type D Keg Cap, No Logo, Red
KGC-D-WHITE	Type D Keg Cap, No Logo, White

Branded keg caps available with your logo. Speak to a sales representative for a free mock-up.



Keg Spear Parts

SKU	Description
KGP06-2058	D Type, Spear Retaining Ring, DSI/MicroMatic
KGP50-1125	D Type, Spear CO2 Valve, DSI
KGP112-895	D Type, Spear CO2 Valve, MicroMatic
KGP47-0003	D Type, Spear St. Steel Ball, DSI/MicroMatic
KGP100-008	D Type, Spear Beer Spring, MicroMatic
KGP47-0001	D Type, Spear Beer Spring, DSI
KGP100-007	D Type, Spear CO2 Spring, MicroMatic
KGP700-357	D Type, Spear Retaining Disc, MicroMatic
KGP45-0017	D Type, Spear O-Ring, DSI/MicroMatic

DRAUGHT BEER DISPENSE SYSTEM COMPONENTS

KEG COUPLERS

- Complete line of domestic and European keg couplers
- Brass or stainless steel body and probe
- Different types of handles available



UBC Keg Couplers

SKU	Description
CH-DSS	D Type, Stainless Steel Probe and Body
CH-SSS	S type, Stainless Steel (Stella Artois, Beck's, Leffe, Czechvar)
CH-G	G type (Bass, Grolsch, Tennent's, Boddington's)
CH-U	U type (Guinness, Harp)
CH-A	A type (Hogaarden, Staropramen)



CH-DSS



CH-SSS



CH-A

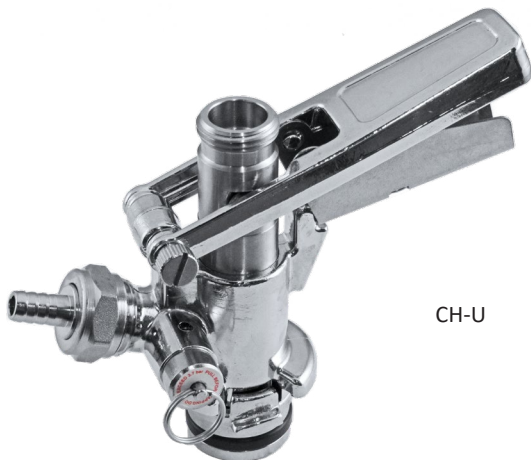

CH-U



CH-G

DRAUGHT BEER DISPENSE SYSTEM COMPONENTS

KEG COUPLERS



- Complete line of domestic and European keg couplers
- Brass or stainless steel body and probe
- Different types of handles available



CHM-D



CHM-S



CHM-G



CHM-U

MicroMatic Keg Couplers

SKU	Description
CHM-D	D type, MM
CHM-DS	D type, St. Steel, MM
CHM-S	S type, MM (Stella Artois, Beck's, Leffe, Czechvar)
CHM-SS	S type st. steel, MM (Stella Artois, Beck's, Leffe, Czechvar)
CHM-G	G type, MM (Bass, Grolsch, Tennent's, Boddington's)
CHM-U	U type, MM (Guinness, Harp)
CHM-A	A type, MM (Hogaarden, Staropramen)
CHM-M	M type, MM (Einbecker, Zywiec)



CHM-A



CHM-M



CHP137SS



CHP133

Keg Coupler Accessories

SKU	Description
CHP133	Beer Line Wall Bracket - 3 Way
CHP137SS	Beer Y - Fitting, Stainless Steel
CHP741	Straight Shutoff Valve, Stainless Steel

Nut & Washer

SKU	Description
FT1020	Swivel Hex Nut
FT8016	Beer Washer



FT1020



FT8016



CHP741

DRAUGHT BEER DISPENSE SYSTEM COMPONENTS

KEG COUPLER PARTS

- Complete line of keg coupler parts
- Replacement parts for all couplers



Keg Coupler Parts

SKU	Description
CHP014	Keg Coupler Part, Handle Assembly, MM
CHP1014	Keg Coupler Part, Safety Relief Valve
CHP218	Keg Coupler Part, Handle Assembly
CHP220	Keg Coupler Part, Ball
CHP221	Keg Coupler Part, Thomas Valve
CHP224	Keg Coupler Part, Probe Assembly D-Type with Ball and Stopper
CHP225	Keg Coupler Part, Probe Assembly S-Type
CHP226	Keg Coupler Part, Hinge Pin S/S
CHP227	Keg Coupler Part, Gas Nipple 3/8"

SKU	Description
CHP242	Keg Coupler Part, Body Seal
CHP304	Keg Coupler Part, Gas Nipple 5/16"
CHP317	Keg Coupler Part, Probe O-Ring
CHP363	Keg Coupler Part, Hinge Pin S/S, MM
CHP376	Keg Coupler Part, Probe Seal D-Type
CHP383	Keg Coupler Part, Probe S-Type, MM
CHP522	Keg Coupler Part, Probe Seal S-Type
CHP524	Keg Coupler Part, Ball Stop
CHP527	Keg Coupler Part, Ball, MM

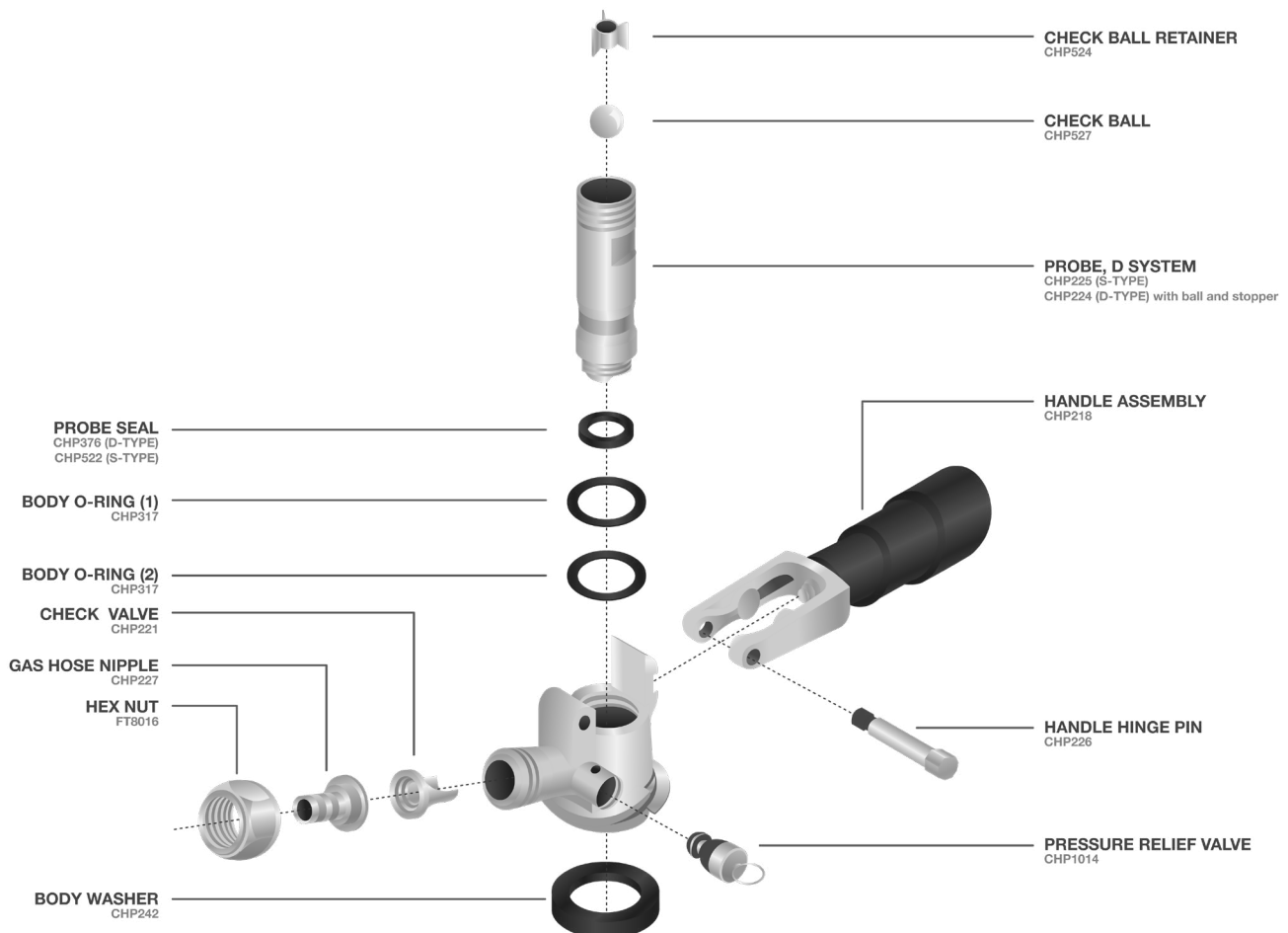

DRAUGHT BEER DISPENSE SYSTEM COMPONENTS

DRAUGHT BEER SYSTEM PARTS



- FOB detectors to eliminate foam and wasted beer
- Beer pumps for dispensing draft beer while maintaining the brewers recommended applied pressure on the beer



FOB/FOB 3



FOB-2



FOB D



FOBUSS2

NEW



JG251210S



JG291208S



FT9018



H0400-005



BPP5000-130



PG56

FOB Controllers

SKU	Description
FOB	FOB Detector Ecoflo 3/8"
FOB2	FOB Detector Classic
FOB3	FOB Detector Ecoflo 3/16"
FOBD	Dual FOB Detector
FOBUSS2	FOB Detector Stainless steel, UBC

FOB Fittings

SKU	Description
JGPI251006S	5/16" Stem to 3/16" Hose
JGPI251008S	5/16" Stem to 1/4" Hose
JGPM250808S	5/16" Stem to 5/16" Hose
JGPI251208S	3/8" Stem to 1/4" Hose
JGPI251210S	3/8" Stem to 5/16" Hose
JGPI251212S	3/8" Stem to 3/8" Hose
JGPI251216S	3/8" Stem to 1/2" Hose
JGPI291208S	3/8" Stem to 1/4" Hose Elbow
FT9018	1/8" Y fitting with 1/8" End, Plastic
H0400-005	Translucent Poly Tubing, 1/8" ID

Beer Pumps

SKU	Description
BPP5000-130	Syrup Pump, FLOJET
PG56	Beer Pump, FLOJET

DRAUGHT BEER DISPENSE SYSTEM COMPONENTS

JOHN GUEST FITTINGS

- Complete line of John Guest fittings
- John Guest push-in fittings are fast and reliable connection alternative over traditional compression and barb fittings when connecting two liquid lines

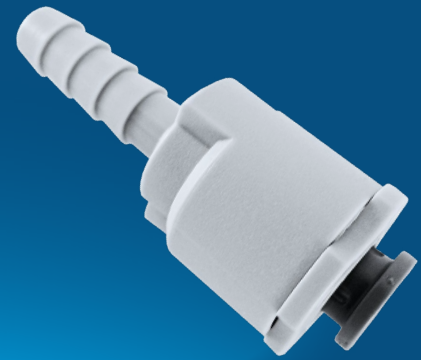

JGSI031012S

JGSI271008S



JGSI271208S

JGPI201612S



JGPI201210S



JGPI211210S



PF6381690

John Guest Superseals

SKU	Description
JGSI031012S	5/16" Superseal x 3/8" SpeedFit Union Elbow
JGSI270808S	1/4" Superseal x 1/4" ID Barb
JGSI271008S	5/16" Superseal x 1/4" ID Barb
JGSI271208S	3/8" Superseal x 1/4" ID Barb
JGSI041210S	Superseal Union Connector 3/8" Superseal - 5/16" Speedfit
JGSM040808S	Superseal Union Connector 5/16" Superseal - 5/16" Speedfit

John Guest Reducers

SKU	Description
JGPI201208S	Reducing Union 3/8" - 1/4"
JGPI201210S	Reducing Union 3/8" - 5/16"
JGPI201612S	Union Reducer 1/2" - 3/8"
JGPI211208S	90 Elbow Reducer 3/8" - 1/4"
JGPI211210S	90 Elbow Reducer 3/8" - 5/16"

John Guest Shut-Offs

SKU	Description
JGPPSV040808W	Propylene Shut-Off Valve, 1/4"
JGPPSV041212W	Propylene Shut-Off Valve, 3/8"
PF6380390	In-Line Plastic Shut-Off 1/4" x 1/4" Barb
PF6381690	In-Line Plastic Shut-Off 3/8" x 3/8" Barb
PF7108490	In-Line Plastic Shut-Off 5/16" x 5/16" Barb



JGPPSV041212W



JGPPSV040808W

DRAUGHT BEER DISPENSE SYSTEM COMPONENTS

JOHN GUEST FITTINGS



- Complete line of John Guest fittings
- John Guest push-in fittings are fast and reliable connection alternative over traditional compression and barb fittings when connecting two liquid lines

CPC Fittings

SKU	Description
CPC17004	CPC Quick Disconnect, 1/4" Socket
CPC17006	CPC Quick Disconnect, 3/8" Socket
CPC22004	CPC Quick Disconnect, 1/4" Plug
CPC22006	CPC Quick Disconnect, 3/8" Plug



CPC17004

CPC22004



JGPI451213S

JGPI451613S

John Guest BSPP

SKU	Description
JGPI011212S	Male Connector 3/8" x 1/4" BSPP
JGPI451213S	Female Connector 3/8" x 3/8" BSPP
JGPI451214FS	Female Connector 3/8" x 1/2" BSPP (Flat End)
JGPI451613S	Female Connector 1/2" x 3/8" BSPP



JGPI121208S

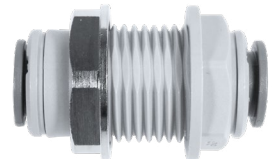

JGPI1212S

John Guest Bulkheads

SKU	Description
JGPI121208S	Reducing Bulkhead Union 3/8" - 1/4"
JGPI1212S	Bulkhead Union 3/8"
JGPI1216S	Bulkhead Union 1/2"



JGPI1216S



JGPIC1808R

John Guest Locking Clips

SKU	Description
JGPIC1808R	1/4" Locking Clip
JGPIC1812R	3/8" Locking Clip

John Guest Tees

SKU	Description
JGPI0208S	Union Tee 1/4"
JGPI0212S	Union Tee 3/8"
JGPI0216S	Union Tee 1/2"



JGPI0208S



JGPI0216S

DRAUGHT BEER DISPENSE SYSTEM COMPONENTS

JOHN GUEST FITTINGS

- Complete line of John Guest fittings
- John Guest push-in fittings are fast and reliable connection alternative over traditional compression and barb fittings when connecting two liquid lines

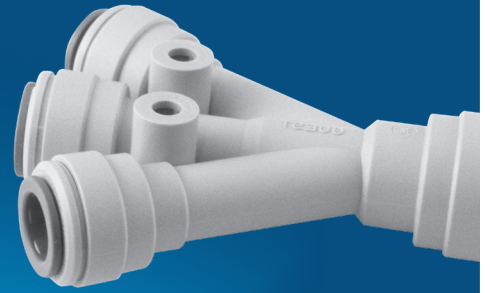

JGPI131216S



JGPI251212S



JGPI251006S



JGPI251008S



JGPI291208S



JGPI251208S



JGPI2312S



JGPI491612S



JGPI0408S



JGPI0412S



JGPI0416S

John Guest Stems

SKU	Description
JGPI131216S	3/8" OD Stem to 1/2" OD Tube Enlarger
JGPI061210S	Reducer 3/8" Stem to 5/16" Tube Grey
JGPI251006S	FOB Fitting, 5/16" Stem to 3/16" Hose
JGPI251008S	FOB Fitting, 5/16" Stem to 1/4" Hose
JGPM250808S	FOB Fitting, 5/16" Stem to 5/16" Hose
JGPI251208S	FOB Fitting, 3/8" Stem to 1/4" Hose
JGPI251210S	FOB Fitting, 3/8" Stem to 5/16" Hose
JGPI251212S	FOB Fitting, 3/8" Stem to 3/8" Hose
JGPI291208S	FOB Fitting, 3/8" Stem to 1/4" Hose Elbow
JGPI251612S	Tube to Hose Stem 1/2" Stem OD - 3/8" Hose ID

John Guest Dividers

SKU	Description
JGPI2312S	Two Way Divider 3/8"
JGPI2316S	Two Way Divider 1/2"
JGPI491612S	Three Way Divider 1/2"

John Guest Connectors

SKU	Description
JGPI0408S	Union Connector 1/4"
JGPI0412S	Union Connector 3/8"
JGPI0416S	Union Connector 1/2"
JGPM0408S	Union Connector 5/16"

DRAUGHT BEER DISPENSE SYSTEM COMPONENTS FITTINGS



- Complete line of generic fittings for draught beer systems
- Stainless steel
- Smooth finish

Elbow Splicers



SKU	Description
FT9002	1/4" Elbow Hose Splicer
FT9005	3/8" Elbow Hose Splicer
FT9015	1/2" Elbow Hose Splicer
FT4107	5/16" Elbow Hose Splicer

Y-Fittings



SKU	Description
FT9051	1/4" Y Fitting with 1/4" End
FT9035	5/16" Y Fitting with 5/16" End
FT9094	3/8" Y Fitting with 1/4" End
FT9095	3/8" Y Fitting with 3/8" End

Stepless Clamps



SKU	Description
FT95	Oetiker Stepless Clamp 09.5
FT105	Oetiker Stepless Clamp 10.5
FT113	Oetiker Stepless Clamp 11.3
FT123	Oetiker Stepless Clamp 12.3
FT133	Oetiker Stepless Clamp 13.3
FT140	Oetiker Stepless Clamp 14.0
FT145	Oetiker Stepless Clamp 14.5
FT157	Oetiker Stepless Clamp 15.7
FT170	Oetiker Stepless Clamp 17.0
FT185	Oetiker Stepless Clamp 18.5
FT198	Oetiker Stepless Clamps 19.8
FT210	Oetiker Stepless Clamp 21.0

Splicers & Reducers



SKU	Description
FT3220	5/16" x 5/16" Hose Splicer
FT3010	3/16" x 3/8" Hose Splicer
FT3022	3/16" x 3/16" Hose Splicer
FT3223	1/4" x 5/16" Hose Splicer
FT3224	5/16" x 3/8" Hose Splicer
FT9001	1/4" x 1/4" Hose Splicer
FT9012	3/8" x 1/4" Hose Splicer
FT9013	3/8" x 3/8" Hose Splicer
FT9130	1/2" x 1/2" Hose Splicer
FT9138	1/2" x 3/8" Hose Splicer

T-Fittings

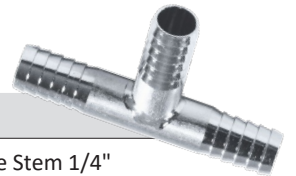

SKU	Description
FT7008	Barb T Two Stems 3/8" One Stem 1/4"
FT7009	Barb T Two Stems 1/4" One Stem 3/8"
FT7079	Barb T Three Stems 1/2"
FT9006	Barb T 1/4"
FT9007	Barb T 3/8"
FT9009	Barb T Two Stems 1/4" One Stem 3/8"
FT9033	Barb T 5/16"

Tail Pieces



SKU	Description
FT1011	1/4" Hose Barb Beer Nut, Nickel Plated Brass
FT1013	3/8" Hose Barb Beer Nut, Nickel Plated Brass
FT3205	1/4" Hose Barb Beer Nut
FT3206	5/16" Hose Barb Beer Nut
FT3207	3/8" Hose Barb Beer Nut
FT3208	1/2" Hose Barb Beer Nut
FT3337	3/16" Hose Barb Beer Nut

DRAUGHT BEER DISPENSE SYSTEM COMPONENTS

FITTINGS

- Complete line of generic fittings for draught beer systems
- Stainless steel
- Smooth finish



Cold Plate Fittings

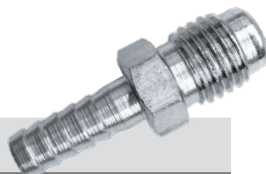

SKU	Description
FT3016	1/4" Barb Fitting
FT3018	3/8" Barb Fitting
FT7254	3/8" NPT x 1/4" Male Flare Fitting with Red Washer
FT8008	5/16" Flare Washer, Red

Crosses

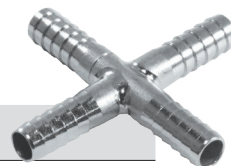

SKU	Description
FT9010	1/4" Hose Cross
FT9011	3/8" Hose Cross

Wall Brackets



SKU	Description
FT9406	SS Wall Bracket with 3/8" Barb
FT9403	Wall Brack with Thread for Beer Nut

U-Bends



SKU	Description
FT4108	5/16" Hose U-Bend
FT9014	1/4" Hose U-Bend
FT9019	3/8" Hose U-Bend
FT9099	3/8" Hose U-Bend Large Radius

90° Tail Pieces



SKU	Description
FT7167	3/16" 90 degree tail piece
FT7106	5/16" 90 degree tail piece
FT7176	1/4" 90 degree tail piece
FT7250	3/8" 90 degree tail piece

Hose Plugs



SKU	Description
FT9027	1/4" Hose Plug
FT3356	5/16" Hose Plug
FT9028	3/8" Hose Plug
FT9030	3/8" x 1/2" x 1/4"

Coil Fittings

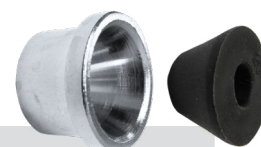

SKU	Description
FT785F	1/4" Ferrule
FT785G	1/4" Grommet
FT786F	5/16" Ferrule
FT786G	5/16" Grommet
FT787F	3/8" Ferrule
FT787G	3/8" Grommet

Gear Clamps



SKU	Description
DMHC5-4	5/16"-3/8" SS Gear Clamp
DMHC5-5	1/2" SS Gear Clamp

DRAUGHT BEER DISPENSE SYSTEM COMPONENTS

TRUNKLINE

- Available in 4 - 16 product line configurations
- Thick 3/4" insulation for efficient cooling
- Class 1 - Flame retardant

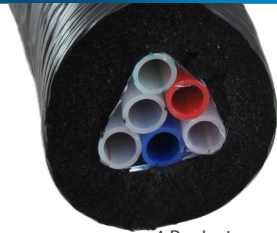

4 Product
2 Glycol



8 Product
2 Glycol



10 Product
4 Glycol



14 Product
4 Glycol

1/4" I.D. Trunk Line

SKU	Description
TRT1491	12 Product / 4 Glycol

3/8" I.D. Trunk Line

SKU	Description
TRT1446	4 Product / 2 Glycol
TRT1447	6 Product / 2 Glycol
TRT1448	8 Product / 2 Glycol
TRT1228	8 Product / 2 Glycol - Barrier Lines NEW
TRT1449	10 Product / 4 Glycol
TRT1461	12 Product / 4 Glycol
TRT1230	12 Product / 4 Glycol - Barrier Lines NEW
TRT1819	16 Product / 4 Glycol

5/16" I.D. Trunk Line

SKU	Description
TRT1441	4 Product / 2 Glycol
TRT1442	6 Product / 2 Glycol
TRT1443	8 Product / 2 Glycol
TRT1222	8 Product / 2 Glycol - Barrier Lines NEW
TRT1444	10 Product / 4 Glycol
TRT1224	12 Product / 4 Glycol - Barrier Lines NEW
TRT1820	16 Product / 4 Glycol
TRT1232	16 product / 4 Glycol - Barrier Lines NEW

3/8" I.D. Glycol Only

SKU	Description
TRT3/8-2	Recirculation bundle, Glycol only, 3/8" ID, 2 lines

Product Highlights

Fire Rating

Class 1 - Flame retardant

Foil Wrap

Efficient cold transfer from glycol lines to beer lines

Color Coded Beer Lines

5/16" or 3/8" I.D.

Moisture Barrier Wrap

Prevent condensation inside trunk line

Insulation

3/4"

Color Coded Glycol Lines

3/8" I.D.



DRAUGHT BEER DISPENSE SYSTEM COMPONENTS

INSULATION TUBING & ACCESSORIES

- Available in 4 - 16 product line configurations
- Thick 3/4" insulataion for efficient cooling
- Class 1 - Flame retardant



Insulation Tube

SKU	Description
IT11812	1 1/8" ID Insulation Tube, 1/2" Wall Thickness, 6' Long
IT11834	1 1/8" ID Insulation Tube, 3/4" Wall Thickness, 6' Long
IT13812	1 3/8" ID Insulation Tube, 1/2" Wall Thickness, 6' Long
IT13834	1 3/8" ID Insulation Tube, 3/4" Wall Thickness, 6' Long
IT15812	1 5/8" ID Insulation Tube, 1/2" Wall Thickness, 6' Long
IT15834	1 5/8" ID Insulation Tube, 3/4" Wall Thickness, 6' Long
IT21812	2 1/8" ID Insulation Tube, 1/2" Wall Thickness, 6' Long
IT21834	2 1/8" ID Insulation Tube, 3/4" Wall Thickness, 6' Long



TL070



BT2



CT2



FIT2



FT2

Tape

SKU	Description
BT2	2" PVC Barrier
CT2	2" Cork
FIT2	2" Foam Insulation
FT2	2" Foil

Accessories

SKU	Description
TL952	Hose Cutter Blade
TL958	Hose Cutter
TL954	Trunkline Cutter
TL070	Trunkline Adjustable Screw Mount Tie



TL954



TL958



TL952

DRAUGHT BEER DISPENSE SYSTEM COMPONENTS

TUBING

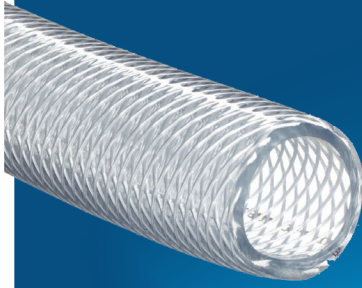

- New ultra-smooth bore tube for ultimate in beverage tube performance
- Low adhesion of bacteria and yeast
- Reduced formation of “beer stone” to extend cleaning cycle
- Color coded beer lines for easier installation

Thermoplastic Vinyl Hose

SKU	Description	ID	OD	Clamp size
HO200-0307	100' Coil, Clear PVC Tubing	3/16"	7/16"	13.3
HO200-0408	100' Coil, Clear PVC Tubing	1/4"	1/2"	14.0
HO200-0509	100' Coil, Clear PVC Tubing	5/16"	9/16"	15.7
HO200-0610	100' Coil, Clear PVC Tubing	3/8"	5/8"	17.0
HO204-0509	100' Coil, Red PVC Tubing for Air Supply	5/16"	9/16"	15.7
HO204-1174	Twin Welded Tubing, Construction 1 x 5/16" ID Red + 1 x 3/8" ID Clear	5/16" 3/8"	9/16" 5/8"	15.7 17.0



Thermoplastic Vinyl Hose

Braided Vinyl Hose

SKU	Description	ID	OD	Clamp size
HOK3150-03	100' Coil, Clear Braided Tubing	3/16"	3/8"	11.3
HOK3150-04	100' Coil, Clear Braided Tubing	1/4"	7/16"	12.3
HOK3150-05	100' Coil, Clear Braided Tubing	5/16"	17/32"	14.0
HOK3150-06	100' Coil, Clear Braided Tubing	3/8"	19/32"	17.0
HOK3150-08	100' Coil, Clear Braided Tubing	1/2"	3/4"	21.0



Braided Vinyl Hose

Polyethylene Hose

SKU	Description	ID	OD	Clamp size
HO222-0662	100' Coil, Translucent Poly Tubing	1/4"	3/8"	10.5
HO222-0862	100' Coil, Translucent Poly Tubing	3/8"	1/2"	13.3



Polyethylene Hose

Bev-Seal Ultra Beverage Tubing

SKU	Description	ID	OD	Clamp size
HO228-0762	Bev-Seal Ultra Beverage Tubing, 5/16" ID	5/16"	7/16"	12.3
HO235-0662	Bev-Seal Ultra Beverage Tubing, 1/4" ID	1/4"	3/8"	11.3
HO235-0862	Bev-Seal Ultra Beverage Tubing, 3/8" ID	3/8"	1/2"	13.3



Bev-Seal Tubing

KEGERATORS



Kegerators

- Variety of direct draw kegerators from single door to triple door units
- Heavy duty construction
- Stainless steel interior and counter top

■ Kegmaster 2	107
■ Kegmaster ECO	108
■ Kegmaster Craft	109
■ KegBar BB-100	110
■ Large Kegerators	111
■ Kegerator Accessories	112

KEGERATORS

KEGMASTER 2

- New more compact construction
- Cooling unit slides out for easy service
- Stainless steel interior and counter top
- Beer tower is cooled by forced air

Kegmaster 2

Description	KEGMASTER 2
Size without packaging HxDxW	39x31x24 in
Capacity	1/2 Barrel - 1 Keg 1/4 Barrel - 2 Kegs 1/6 Barrel - 4 Kegs
Noise	Not more than 65 db
Forced interior air circulation	Yes
Operating amperage	4.2 A
Dedicated circuit	15 A
Thermostat model	Manual
Compressor capacity	1/5 HP
Refrigerant type	R134-A
Wall thickness	1.7 in
Interior material	Stainless Steel
Door lock	Yes
Wheels	Yes
Weight Net/Gross	150 lbs / 160 lbs
Branding	Available as an option



KEGMASTER 2

Keg Configurations



Branding available as an option

KEGERATORS

KEGMASTER ECO

- Eco-friendly kegerator; saves on electrical costs
- Wheels at the back, legs at the front to keep unit secured in place
- Stainless steel interior and counter top
- Beer tower is cooled by forced air



KEGMASTER ECO

Kegmaster Eco

Description	KEGMASTER ECO
Size without packaging HxDxW	39x31x24 in
Capacity	1/2 Barrel - 1 Keg 1/4 Barrel - 2 Kegs 1/6 Barrel - 4 Kegs
Noise	Not more than 65 db
Forced interior air circulation	Yes
Operating amperage	4.0 A
Dedicated circuit	15 A
Thermostat model	Manual
Compressor capacity	1/6 HP
Refrigerant type	R134-A
Wall thickness	1.7 in
Interior material	Stainless Steel
Door lock	Yes
Wheels	Two in rear, leg posts in front
Weight Net/Gross	150 lbs / 160 lbs
Branding	Available as an option

Keg Configurations

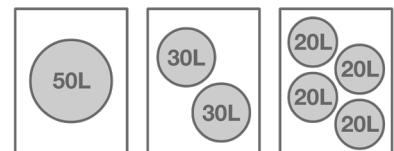

Branding available as an option

KEGERATORS

KEGMASTER CRAFT

- New slim kegerator design
- Designed to take up less space
- Stainless steel interior and counter top
- Beer tower is cooled by forced air

Kegmaster Craft

Description	KEGMASTER CRAFT
Size without packaging HxDxW	39x31x19 in
Electrical network	115V, 60Hz
Compressor Power, HP	1/6
Internal Volume, L	185
Net Volume, L	165
Refrigerant	R134a
Power Cord Length, M	2
Clearance	At least 80mm around the entire unit
Refrigerant (R-134) charge, KG	0,135
Maximum Capacity Keg Container 30L Slim / 20L Slim)	2/2



Keg Configurations



KEGMASTER CRAFT



Branding available as an option

KEGERATORS

KEGBAR BB-100

- New innovative design featuring front ventilation
- Designed to be installed in a tight space
- Stainless steel interior and counter top
- Cassette type cooling unit for easy service



Kegbar BB-100

KEGBAR BB-100	
Size without packaging HxDxW	39x28x33 in
Capacity	1/2 barrel - 1 keg 1/4 barrel - 2 kegs 1/6 barrel - 4 kegs
Tower	American 3" or Gefest Stainless Steel
Height with tower (American/Gefest)	52/58 in
Noise	Not more than 65 db
Forced interior air circulation	Yes
Operating amperage	5.3 A
Dedicated circuit	15 A
Thermostat model	Digital
Compressor capacity	1/4+ hp (944 Wt)
Refrigerant type	R134-a
Wall thickness	1.7 in
Interior material	Stainless Steel
Door lock	Yes
Wheels	Yes
Weight Net/Gross	212 lbs / 225 lbs
Branding	Available as an option



KEGBAR BB-100



Keg Configurations

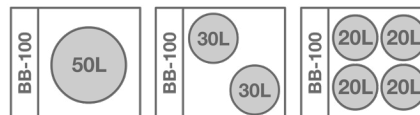

KEGERATORS

LARGE KEGERATORS

- Direct draw draught beer coolers
- Stainless steel interior and counter top
- Air cooled stainless steel beer towers
- Built-in drip tray



ADD C-94



ADD C-58

Description	ADD C-58	ADD C-68	ADD C-78	ADD C-94
Net Capacity (Cu. ft.)	20.82	25.49	28.2	37.65
Width, Overall (in.)	59 1/2"	69 1/2"	80"	95 1/2"
Depth, Overall (in.)	28 1/2"			
Height, Overall (in.) (Not including 12" Towers)	37"			
Number of Doors	2		3	
Condensing Unit Size (H.P.)	1/3			
Refrigerant	R-134A			
Cabinet Electrical Specs	115/60			
Total Amps	6.6		6.9	7.2
Power Supply Cord (10 ft.)	YES			
Shipping Weight (lbs.)	343	370	396	429

Keg Configurations

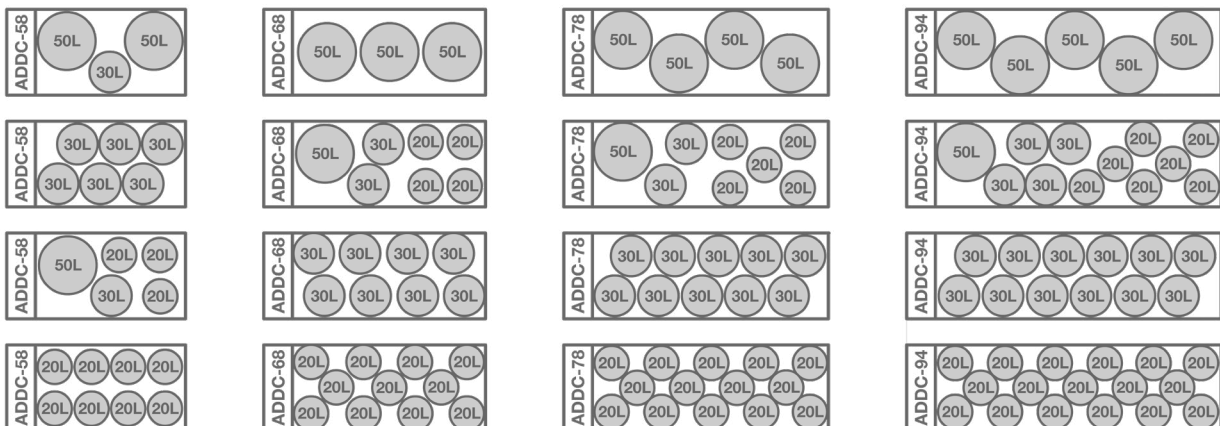

KEGERATORS

LARGE KEGERATORS

- New line of kegerators in stock
- Kegerator line cleaning kits
- Kegerator tapping kits
- Branding for kegerators
- CO2 / N2 Tanks

Beer Line Cleaning Kits

SKU	Description
LCK-1	Direct Draw System, 1 Qt
LCK-D	Direct Draw System, 1.3 Gallon

Kegerator Branding

Name	SKU
Door Branding	BRANDING-KG-Door
Door & Sides Branding	BRANDING-KG-Full

CO2 / N2 Tanks

Name	SKU
CO2 Tank, 2.5 lbs	CO2-2.5
CO2 Tank, 5 lbs	CO2-5
N2 Tank	N2-5

Our 5 lb aluminum alloy CO2 cylinders are certified and stamped for use in the USA (US DOT 3AL) and also Canada (TC-3ALM).



CDD-58

Description	CDD-58
Net Capacity (Cu. ft.)	20.82
Width, Overall (in.)	58 7/8"
Depth, Overall (in.)	27 3/4"
Height, Overall (in.) (Not including 12" Towers)	36 1/4"
Number of Doors	2
Condensing Unit Size (H.P.)	1/5
Refrigerant	R290A
Cabinet Electrical Specs	115/60
Total Amps	6.6
Power Supply Cord (10 ft.)	YES
Shipping Weight (lbs.)	343

Kegerator Tapping Kits (CO2)

SKU	Faucets	Includes
KK1-ASM	1	Primary CO2 Regulator, Gauge Guard, Keg Coupler - D Type, Hosing, Clamps
KK2-ASM	2	Primary CO2 Regulator, Gauge Guard, Keg Couplers - D Type (2), Air Distributor, Hosing, Clamps
KK3-ASM	3	Primary CO2 Regulator, Gauge Guard, Keg Couplers - D Type (3), Air Distributor, Hosing, Clamps
KK4-ASM	4	Primary CO2 Regulator, Gauge Guard, Keg Couplers - D Type (4), Air Distributor, Hosing, Clamps



REACH-IN REFRIGERATORS



Reach-in Refrigerators

- Large glass surface for increased visibility
- Extra large interior usable space
- Highest climate class - class 4 (outdoor use)
- Branded exterior walls (optional)
- Galvanized steel case primed on both sides and painted on the outer side for increased durability and anti-corrosion

■ Display Cooler	114
■ Virgo Slim Refrigerator	115
■ Smart Cool 350	116
■ IceStream OPTIMA	117
■ IceStream SUPER LARGE	118

REACH-IN REFRIGERATORS DISPLAY COOLER

- Heavy-duty construction
- Available branded or non-branded
- Great for display purposes on bar

Display Cooler

Description	SC52B
Capacity	52 Litre
Unit Size HxDxW	31x18x16.5 in
Inner Cabinet Size HxDxW	20x12x13 in
Refrigerant Type	R134a
Power Supply	110V/60Hz
Input Power	76 W
Temperature	0 to 10°C



Can Cooler

Description	IS-50CAN
Capacity	50 Litre
Unit Size H x ø	34x17.4 in
Inner Cabinet Size H x ø	24x13.4 in
Refrigerant Type	R600a
Power Supply	110V/60Hz
Temperature	+2 to +10°C



NEW



Branding available as an option

REACH-IN REFRIGERATORS

VIRGO SLIM REFRIGERATOR

- Heavy-duty construction
- Fits into tighter spaces
- Illuminated lightbox with a logoed screen

Virgo Slim Refrigerator

Description	SC-105JP
Size without packaging HxDxW	74x16x14 in
Int. volume	3.71 cu ft
Noise	Not more than 55 db
Interior lighting	LED
Forced interior air circulation	Yes
Evaporator type	Static cooling, aluminum roll-bond
Forced condenser cooling	No
Operating amperage	1.0 A
Thermostat model	Mechanical
Compressor type	Siklan ADW77T6
Compressor capacity	1/4 hp
Refrigerant Type	R-134a
Wall thickness	1.5 in
Interior material	Metal
Interior steel gauge	0.5 mm
Qty of shelves	5
Door lock	No
Wheels	No
Weight (Net)	114 lbs (52kg)



Branding available as an option

REACH-IN REFRIGERATORS

SMART COOL 350

- Heavy-duty construction
- Energy efficient door frames
- Embraco 1/6 hp compressor
- Digital thermostat
- Forced air ribbed pipe evaporator
- Illuminated lightbox with a logoed screen

IceStream Smart Cool

Description	IS-SC
Size without packaging HxDxW	82x23x24 in
Int. volume, L	350
Noise	Not more than 55 db
Interior lighting	Philips, DeLux, Osram
Forced interior air circulation	Yes
Evaporator type	Static cooling, aluminum roll-bond
Forced condenser cooling	No
Operating amperage	1.9 A
Thermostat model	Dixell XR02CX
Compressor type	Embraco EMT6144U
Compressor capacity	1/5 hp
Wall thickness	1.5 in
Interior material	Metal
Interior steel gauge	0.5 mm
Qty of shelves	4
Door lock	Yes
Wheels	Yes
Weight (Net)	187 lbs (85 kg)



Shelf Dividers

SKU	Description
VS12-10	Merchandising Glide Rack VISI SLIDE, 12oz, 10 Rows Wide
VS16-10	Merchandising Glide Rack VISI SLIDE, 16oz, 10 Rows Wide
VS20-9	Merchandising Glick Rack VISI SLIDE, 20oz, 9 Rows Wide
VF12-10	Merchandising System Rack VISI FAST, 12oz, 10 Rows Wide
VF20-8	Merchandising System Rack VISI FAST, 20oz, 8 Rows Wide



Branding and/or customization is available

REACH-IN REFRIGERATORS

IceStream OPTIMA

- Heavy-duty design
- 3/8 hp Embraco compressor
- Large interior usable space
- Vertical built-in lighting for better product visibility
- Door lock
- Custom branding available on request

IceStream Optima



Description	IS-O
Size without packaging HxDxW	81x30x32 in
Int. volume, L	712
Noise	Not more than 65 db
Interior lighting	Philips, DeLux, Osram
Forced interior air circulation	Yes
Evaporator type	Dynamic cooling, ribbed pipe
Forced condenser cooling	Yes
Operating amperage	3.1 A
Thermostat model	AKO 13120 / Dixell XR02CX
Compressor type	Embraco NE6210Z
Compressor power	1/2 hp
Refrigerant type	R600a/R290
Wall thickness	2.3 in, foam filled
Interior material	Metal
Interior steel gauge	0.5 mm
Qty of shelves	5
Door lock	Yes
Wheels	Rear wheels, front adjustable legs
Weight (Net)	330 lbs (150 kg)

Branding and/or customization is available



REACH-IN REFRIGERATORS

IceStream SUPER LARGE

- Heavy-duty design
- 1/2 hp Tecumseh compressor
- Vertical built-in lighting for better product visibility
- Sliding doors with a lock
- Large interior usable space
- Custom branding available on request

IceStream Super Large

Description	IS-SL
Size without packaging HxDxW	81x31x51 in
Int. volume	42.4 cu ft
Noise	Not more than 65 db
Interior lighting	Philips, DeLux, Osram
Forced interior air circulation	Yes
Evaporator type	Dynamic cooling, ribbed pipe
Forced condenser cooling	Yes
Operating amperage	4.7 A
Thermostat model	AKO 13120 / Dixell XR02CX
Compressor type	Tecumseh CAJ4461Y
Compressor capacity	3/4 hp
Wall thickness	2.3 in
Interior material	Metal
Interior steel gauge	0.5 mm
Qty of shelves	10
Door lock	Yes
Wheels	Yes
Weight (Net)	485 lbs (220 kg)



Branding and/or customization is available

BACK BAR COOLERS



Back Bar Coolers

- Single door to triple door back bar refrigerators
- Front ventilation and cassette type cooling unit for easy service

■ CoolBar BB-100	120
■ Large Back Bar Coolers	121

BACK BAR COOLERS

COOLBAR BB100

- All stainless steel top and interior
- Front ventilation
- Energy efficient, “Low-E”, double pane thermal insulated glass door
- Heavy duty PVC coated wire shelves

CoolBar BB-100

Description	COOLBAR BB-100
Size Without Packaging HxDxW	39x28x33 in
Internal Volume	8.2 cu ft
Capacity	315 Bottles (0.33L)
Noise	Not more than 65 db
Interior Lighting	LED
Forced Interior Air Circulation	Yes
Evaporator Type	Dynamic Cooling, Ribbed Pipe
Forced Condenser Cooling	Yes
Operating Amperage	5.3 A
Dedicated Circuit	15 A
Thermostat Model	Digital
Compressor Capacity	1/4+ hp (944 Wt)
Refrigerant Type	R134-a
Wall Thickness	1.7 in
Interior Material	Stainless Steel
Quantity of Shelves	3
Door Lock	Yes
Wheels	Yes
Weight Net/Gross	212 lbs / 225 lbs
Branding	Available as an Option



Sliding refrigeration module for easier servicing

BACK BAR COOLERS

LARGE BACK BAR COOLERS

- Heavy-duty design
- Enhanced refrigeration system
- Left side mount compressor and front breathing
- Analog or digital thermostat
- Adjustable coated wire shelves
- Solid and glass door options

Back Bar Coolers

Description	2 DOOR COOLER	2 DOOR COOLER	3 DOOR COOLER	3 DOOR COOLER
Part Number	ABBC-58	ABBC-68	ABBC-78	ABBC-94
Doors	2		3	
Capacity	852	1,014	1,092	1302
Shelves	4		6	
Total Amps	6.6		6.9	7.2
HP	1/3			
Voltage	115/60/1			
Nema Plug	5-15P			
Cord length	8'			
Length (in.)	59 1/2"	69 1/2"	80"	95 1/2"
Depth (in.)	28"			
Height (in.)	37"			
Shipping Weight	343 lbs	370 lbs	396 lbs.	429 lbs.

*NOTE: A minimum clearance of 3" on each side, front and rear of cabinet is required for optimum performance.



ABBC-94



ABBC-58

Wheels sold separately

Glass doors available upon request

BACK BAR COOLERS

LARGE BACK BAR COOLERS

- Heavy-duty design
- Enhanced refrigeration system
- Left side mount compressor and front breathing
- Analog or digital thermostat
- Adjustable coated wire shelves
- Solid and glass door options

*NOTE: A minimum clearance of 3" on each side, front and rear of cabinet is required for optimum performance.



CBB-58G

Glass Door Back Bar Coolers

Description	2 GLASS DOOR COOLER
Part Number	CBB-58G
Doors	2
Capacity (12 Oz Can)	852
Shelves	4
Total Amps	2.88
HP	1/5
Voltage	115/60/1
Nema Plug	5-15P
Cord Length	9'
Length (in.)	58 7/8"
Depth (in.)	29 1/8"
Height (in.)	36 1/4"
Shipping Weight	297 lbs

Product Features

- Glass-doors for improved product visibility.
- Foamed-in-place polyurethane insulation provides unit with structural integrity
- Interior is illuminated by LED lights for product visibility
- 304 Stainless Steel interior and surface

MOBILE AND EVENT BEER COOLING & DISPENSING



Mobile and Event Beer Cooling & Dispensing

- A great way to keep the beer flowing where built-in systems can not be used
- Cold kegged beer anywhere, anytime without using electricity
- All you need is ice for cooling beer and CO₂ for dispensing
- Can be used for dispensing other beverages - soda water, bag-in-box juices or wine

■ Mobile Dispense Parts	124
■ Jockey Box Picnic Coolers	125
■ Jockey Box Tapping Kits	127

MOBILE AND EVENT BEER COOLING & DISPENSING

MOBILE DISPENSE PARTS

- Reliable parts to make your event a success
- Can be used outdoors
- Commercial grade parts for home use
- Parts to use when creating your own patio beer dispenser



JBA50

JBA70

JBA120

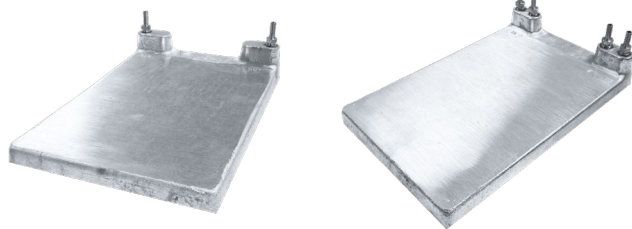

JBA0812-1

JBA1015-2



KP501



High Efficiency Product Coils

SKU	Coil O.D.	Coil Length	Height	Width	Depth
JBA50	5/16"	50'	5 1/2"	5 1/4"	7 1/2"
JBA70	5/16"	70'	6 1/2"	9"	9"
JBA119	5/16"	119'	9"	9 1/2"	9 1/2"
JBA120	5/16"	120'	9"	9 1/2"	9 1/2"

Cold Plates

SKU	Description
JBA0812-1	Cold Plate 8"x12", 1 product, 1/4" barb
JBA0812-2	Cold Plate 8"x12", 2 products, 1/4" barb
JBA1015-2	Cold Plate 10"x15", 2 products, 1/4" barb
JBA0814-4	Cold Plate 8"x14", 4 products, 1/4" barb
JBA0814-8	Cold Plate 8"x14", 8 products, 1/4" barb

Cold Plate Fittings

SKU	Description
FT3016	1/4" Barb Fitting
FT3018	3/8" Barb Fitting
FT7254	3/8" NPT x 1/4" Male Flare Fitting with Red Washer
FT8008	5/16" Flare Washer, Red

Party Pump Parts

SKU	Description
KP004C-B	Keg Pump Body, 4"
KP008C-B	Keg Pump Body, 8"
KPP0084FC	Plastic Faucet
KPP0084C	Plastic Faucet with Tube
KPP393	Pump, O-Ring
KPP395	Pump Thomas Valve

CO2/N Tanks

SKU	Description
CO2-2.5	CO2 Tank, 2.5Lbs
CO2-5	CO2 Tank, 5Lbs
N2-5	N2 Tank, 5Lbs

Party Pumps

SKU	Description
KP004C	Keg Pump, 4"
KP008C	Keg Pump, 8"
KP008F	Keg Pump with Faucet, 8"
KP501	Pony Keg Pump



KP008F

KP008C

MOBILE AND EVENT BEER COOLING & DISPENSING

JOCKEY BOX PICNIC COOLERS

- 304 stainless steel coil(s)
- Square coils for a better fit in the cooler
- Coils stand on legs to allow ice-cold water to chill beer from underneath
- 50', 70', or 120' coils

Jockey Boxes, Plastic

SKU	Faucets	Finishing	Coil Length	Coil O.D.	W idth	H eight	D epth
JB50-1	1	Plastic	50'	5/16"	23 3/4"	14"	13 1/4"
JB70-1	1	Plastic	70'	5/16"	23 3/4"	14"	13 1/4"
JB120-1	1	Plastic	120'	5/16"	23 3/4"	14"	13 1/4"
JB50-2	2	Plastic	2 x 50'	5/16"	23 3/4"	14"	13 1/4"
JB70-2	2	Plastic	2 x 70'	5/16"	23 3/4"	14"	13 1/4"
JB120-2	2	Plastic	2 x 120'	5/16"	23 3/4"	14"	13 1/4"
JB50-3	3	Plastic	3 x 50'	5/16"	23 3/4"	14"	13 1/4"
JB6x50-3	3	Plastic	3 x 100'	5/16"	23 3/4"	14"	13 1/4"
JB50-4	4	Plastic	4 x 50'	5/16"	23 3/4"	14"	13 1/4"
JB50-5	5	Plastic	50'	5/16"	23 3/4"	14"	13 1/4"



Cooler Size **48Qt.**



Cooler Size **54Qt.**

Jockey Boxes, Stainless Steel

SKU	Faucets	Finishing	Coil Length	Coil O.D.	W idth	H eight	D epth
JB70SS-1	1	Stainless Steel	70'	5/16"	24"	16 1/2"	15"
JB120SS-1	1	Stainless Steel	120'	5/16"	24"	16 1/2"	15"
JB50SS-2	2	Stainless Steel	2 x 50'	5/16"	24"	16 1/2"	15"
JB70SS-2	2	Stainless Steel	2 x 70'	5/16"	24"	16 1/2"	15"
JB120SS-2	2	Stainless Steel	2 x 120'	5/16"	24"	16 1/2"	15"
JB50SS-3	3	Stainless Steel	3 x 50'	5/16"	24"	16 1/2"	15"
JB50SS-4	4	Stainless Steel	4 x 50'	5/16"	24"	16 1/2"	15"



Branded Jockey Boxes on Page 136

MOBILE AND EVENT BEER COOLING & DISPENSING JOCKEY BOX PICNIC COOLERS

- 304 stainless steel coil(s)
- Square coils for a better fit in the cooler
- Coils stand on legs to allow ice-cold water to chill beer from underneath
- 50', 70', or 120' coils



Jockey Boxes, Stainless Steel with Tower

SKU	Faucets	Finishing	Coil Length	W idth	H eight	D epth
JB50SS-2T	2	Stainless Steel	2 x 50'	24"	16 1/2"	15"
JB70SS-2T	2	Stainless Steel	2 x 70'	24"	16 1/2"	15"
JB120SS-2T	2	Stainless Steel	2 x 120'	24"	16 1/2"	15"
JB316SS-3 (wine)	3	Stainless Steel	70'	24"	16 1/2"	15"

Jockey Boxes, Retro Coolers

SKU	Faucets	Finishing	Coil Length	W idth	H eight	D epth
JB50-1R	1	Stainless Steel	50'	11.5"	13"	9 1/2"
JB50-1X2R	1	Stainless Steel	100'	11.5"	13"	9 1/2"
JB50-2R	2	Stainless Steel	50'	11.5"	13"	9 1/2"

Retro Coolers

SKU	Finishing	W idth	H eight	D epth
13L Cooler, Black	Stainless Steel	11.5"	13"	9 1/2"



JB50-1R



JB50-1X2R
(inside view)



13L Cooler, Black

Customize your own retro jockey box with a jockey box DIY kit with 50' coil

MOBILE AND EVENT BEER COOLING & DISPENSING

JOCKEY BOX TAPPING KITS

- Jockey box tapping kits for 1-5 lines
- Includes everything to connect to the keg and CO2 or Nitrogen tank
- Each kit includes Sanke D-type SS probe coupler(s), Primary CO2 or Nitrogen regulator, air distributor, quick disconnects, tubing and clamps, ready to plug-and-play with the jockey box!

Jockey Box Tapping Kits (CO2)

SKU	Faucets	Includes
JBK1-ASM	1	Jockey Box 1 line Tapping Kit, CO2
JBK2-ASM	2	Jockey Box 2 lines Tapping Kit, CO2
JBK2SEC-ASM	2	Jockey Box 2 lines Tapping Kit with 2 products Secondary regulator, CO2
JBK3-ASM	3	Jockey Box 3 lines Tapping Kit, CO2
JBK3SEC-ASM	3	Jockey Box 3 lines Tapping Kit with 3 products Secondary regulator, CO2
JBK4-ASM	4	Jockey Box 4 lines Tapping Kit, CO2
JBK4SEC-ASM	4	Jockey Box 4 lines Tapping Kit with 4 products Secondary regulator, CO2
JBK5-ASM	5	Jockey Box 5 lines Tapping Kit, CO2
JBK5SEC-ASM	5	Jockey Box 5 lines Tapping Kit with 5 products Secondary regulator, CO2



Jockey Box Tapping Kits (N2)

SKU	Faucets	Includes
JBK1N-ASM	1	Jockey Box 1 line Tapping Kit, Nitrogen
JBK2N-ASM	2	Jockey Box 2 lines Tapping Kit, Nitrogen
JBK2NSEC-ASM	2	Jockey Box 2 lines Tapping Kit with 2 products Secondary regulator, Nitrogen
JBK3N-ASM	3	Jockey Box 3 lines Tapping Kit, Nitrogen
JBKNSEC-ASM	3	Jockey Box 3 lines Tapping Kit with 3 products Secondary regulator, Nitrogen
JBK4N-ASM	4	Jockey Box 4 lines Tapping Kit, Nitrogen
JBK4NSEC-ASM	4	Jockey Box 4 lines Tapping Kit with 4 products Secondary regulator, Nitrogen
JBK5N-ASM	5	Jockey Box 5 lines Tapping Kit, Nitrogen
JBK5NSEC-ASM	5	Jockey Box 5 lines Tapping Kit with 5 products Secondary regulator, Nitrogen



Secondary regulators available in tapping kits

Jockey Box DIY Assembly Kits

SKU	Coil Length	Includes
JBAK50-1	50'	Coil, Shank Assembly, Faucet, Hosing, Fittings, etc.
JBAK70-1	70'	Coil, Shank Assembly, Faucet, Hosing, Fittings, etc.
JBAK120-1	120'	Coil, Shank Assembly, Faucet, Hosing, Fittings, etc.



INSTALLATION AND MAINTENANCE TOOLS



Installation and Maintenance Tools

- Generic tools for installation and maintenance of draught beer systems
- Solutions and tools for professional beer line cleaning

■ Tools & Accessories	130
■ Beer Line Cleaning Equipment	131

NEW



PIPELINE FOURTEEN



PIPELINE GOLD PROFESSIONAL

PROFESSIONAL BEER LINE CLEANERS

- + CHANGES COLOR WHEN LINES ARE DIRTY
- + SAVE ON BEER LOSS, WATER & TIME
- + DESIGNED FOR A BI-MONTHLY CLEANING REGIME

- + CHLORINE FREE
- + UNRIVALLED PERFORMANCE
- + LEAVES LINES ATONISHINGLY CLEAN

Concentrated purple beer line cleaner for quick and efficient application and long-lasting effect. Designed to be employed every two weeks, after the beverage dispense system has been thoroughly treated with Pipeline Bottoming Out Kit, delivering significant savings on time, ullage and water.

Professional strength chlorine-free beverage dispense system cleaner. This highly concentrated version of Pipeline Gold is recommended for use by professional cleaning technicians for its exceptional cleaning power.

INSTALLATION AND MAINTENANCE TOOLS

TOOLS & ACCESSORIES

- Generic tools for installation and maintenance of draught beer systems

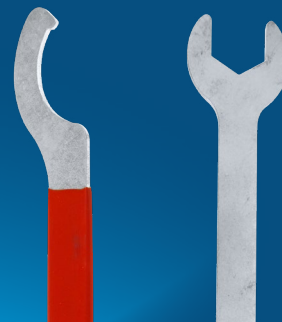

TRK-50R



TRK-53D



TL104



ST-01



TL-200



TL123



TL187



TL100



TL260



TL261



TL271



TL237



TL270-BCT



GL-1G

Thermostats

SKU	Description
TRK-1C1	Digital Thermostat ETC
TRK-50R	Manual Thermostat Ranco K50
TRK-53D	Digital Thermostat Dixell
ST-01	Spirit thermometer
TL104	Digital Thermometer

Faucet Accessories

SKU	Description
TL107	Draft Arm Wrench
TL187	Faucet Wrench
TL187HD	Faucet Wrench, Heavy Duty
TL123	Faucet & Hex Nut Wrench
TL271	Faucet Cleaning Brush
TL237	Double Sided Faucet Brush

Other Accessories

SKU	Description
TL260	CO2 Wrench - Off Set
TL261	CO2 Wrench - Standard
TL200	Spanner Brass Chrome
TL100	Clamp Crimper Standard
TL202	Tube Sizing Rod
TL2701-BCT	Beer Carbonation Tester with Protective Case

Propylene Glycol

SKU	Description
GL-1G	1 Gallon
GLD	53 Gallon Drum

INSTALLATION AND MAINTENANCE TOOLS BEER LINE CLEANING EQUIPMENT

- Solutions and tools for professional beer line cleaning

Beer Line Cleaning Kits

SKU	Description
LCK-1	Direct Draw System, 1 Qt Cleaning Kit
LCK-DP	Direct Draw System, 1.3 Gallon Cleaning Kit, D Valve Plastic Fitting
LCK-DM	Direct Draw System, 1.3 Gallon Cleaning Kit, D Valve Metal Fitting

Cleaning Accessories and Parts

SKU	Description
LCP100	Manual Relief Valve for Cleaning Tanks
LCP103	Back Plate
LCP104	Plastic Series Flasher, No Ball Lifter
LCP108	Single Flusher for Single Hole Keg Valve Taps
LCP109	SS Series Flusher with Ball Lifter
LCP110	Double Flusher for Single Hole Keg Valve Taps
LCP1301	Single Flusher - G
LCP2A1	Single Flusher - A
LCP4353	Straight Cleaning Attachment with 5/16" Hose Barb End (2 pc.)
LCP801	End Stop Cap - In Place Cleaning Caps
LCP851	Ball Lifter for cleaning from the faucet through the coupler
LCP901	Stainless Steel Mounting Board with Handle
LCP902	Duplex Coupling Connects 2 Beer Lines for Simultaneous Cleaning
LCP934	4 oz. tube lubricant
LCP938	8 oz. tin of probe lubricant

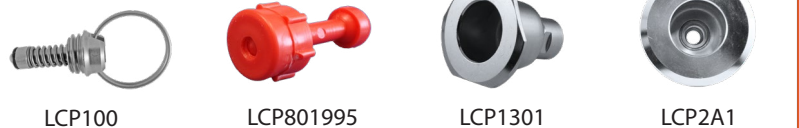

Stainless steel head/
valve kit also available

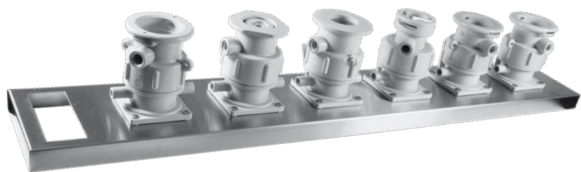

LCP901
(with attachments)

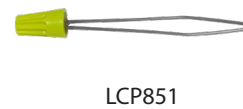

INSTALLATION AND MAINTENANCE TOOLS

BEER LINE CLEANING EQUIPMENT

■ Solutions and tools for professional beer line cleaning



LCF001A



LCF002G



LCF003S



LCF005D



LCF006U



LCF007M

Cleaning Valves

SKU	Description
LCF001A	A System Valve: Warsteiner, Paulaner, Spaten
LCF002G	G System Valve: Bass, Anchor Steam, Boddington
LCF003S	S System Valve: Heineken, Beck's, Scottish & Newcastle
LCF005D	D System Valve: Anheuser-Busch, Coors, Miller, Yuengling
LCF006U	U System Valve: Guinness, Harp
LCF007M	M System Valve: Schneider, Aventinus, Einbecker

Cleaning Cans

SKU	Description
LCT1455	1.3 Gallon Plastic Cleaning Can with one head*
LCT312-CH	2.4 Gallon Stainless Steel Cleaning Can with two heads, Economy*
LCT312	2.4 Gallon Stainless Steel Cleaning Can with two heads*
LCT320	2.4 Gallon Stainless Steel Cleaning Can with four heads*
LCT412-CH	4 Gallon Stainless Steel Cleaning Can with two heads, Economy*
LCT412	4.8 Gallon Stainless Steel Cleaning Can with two heads*
LCT420	4.8 Gallon Stainless Steel Cleaning Can with four heads*

*Cleaning valves sold separately



LCT1455



LCT412-CH

LCT312-CH



LCT420

LCT312

INSTALLATION AND MAINTENANCE TOOLS BEER LINE CLEANING EQUIPMENT



- Solutions and tools for professional beer line cleaning

Cleaning Caps

SKU	Description
LCF801147	D type cleaning plastic cap
LCF808033	S type cleaning plastic cap
LCF808041	U type cleaning plastic cap
LCF808051	G type cleaning plastic cap
LCF808053	A type cleaning plastic cap
LCF802912KS	D type cleaning panel plastic cap
LCF802064KS	A type cleaning panel plastic cap
LCF801184KS	S type cleaning panel plastic cap
LCF801180KS	G type cleaning panel plastic cap
LCF801174KS	U type cleaning panel plastic cap
LC110000S	5L. Dip Tube



Beer Line Cleaners

SKU	Description
LC31002	32 oz beverage system cleaner, BLC
LC1405L	1.3 gal beverage system cleaner, PIPELINE FOURTEEN
LCGP05L	1.3gal beverage system cleaner, PIPELINE GOLD
LC31004	1.9 oz beverage system cleaner, TM DESANA MAX
LC31005	1 gal beverage system cleaner, TM DESANA IC, Liquid
LC31032	32 oz beverage system cleaner, PENETRATE
LC32011	16 oz beverage system cleaner, SUPER NO-RINSE
LC32013	40 lb beverage system cleaner, SUPER NO-RINSE
LC32021	32 oz beverage system cleaner, PLC
LC4933B	1 gal beverage system cleaner, BENEFIT
LC5100	Sanitap Drain Cleaner Strips 5", 10 per package
LC5102	Sanitap Drain Cleaner Strips 12", 10 per package
LC5106	Sanitap Floor Drain Cleaner, 16", 3 per package
LC33023	Beer line Cleaner, 30 ct Keg and Carboy cleaning tablets
LC32041	Beer line Cleaner, 1 lb CM Oxygen brewery wash



LC32041



LC33023



LC32011



LC31032



LC32013

BRWEERY TARGETED PRODUCTS



Brewery Targeted Products

■ Schafer Kegs	135
■ Schafer Tanks	138
■ Branded Towers & Medallions	139
■ PEGAS CrafTap 3.0	140
■ PEGAS CrafPad Lite	141
■ Growler Filling Station	142
■ Ceramic Tap Handles	144
■ Illuminated Pub Signs	144
■ Branded Jockey Boxes	145
■ Patio Umbrellas / Chalkboards	147
■ Tables	149

PRODUCT HIGHLIGHT: KEG BRANDING

- Free mock-ups available
- All kegs can be branded at our warehouse prior to shipment



We Brand Kegs!

UBC Group Canada offers customizable branding options from our on-site keg branding facility to enhance the look of your kegs, using your company logo, wording or specific colours to make sure your keg is unique and professional. Our branding options include:

Embossing



Silk-Screening



Chemical-Etching



Get the Branding Your Brewery Deserves!

Making sure our clients are happy and receive their kegs as quickly as possible is an absolute priority of ours. Now with coast to coast coverage, you can trust us to deliver on time, every time!

With three different in-house branding styles to choose from and - You can be confident knowing your kegs will not only look great but also arrive quickly!



The Benefits of Branding

Branding kegs not only highlights the brand of your brewery, but also prevents loss of the keg and creates a uniform style to make them easily distinguishable. Simply let us know the requirements for your branded kegs and we'll work with you directly to ensure your kegs are completed in the fastest way possible, with careful attention paid to every detail.

BREWERY TARGETED PRODUCTS

SCHAFFER KEGS

- European 304 Stainless Steel kegs
- Micromatic or DSI spears
- Stackable for easier storage
- Embossing, silk screen printing and electric corrosion etching



KGSUD-D50



KGSUD-D30

KGSUD-D20

Schafer SUDEX Kegs

UBC Group is proud to be the exclusive Canadian distributor of Schafer kegs in Canada. Schaefer's 30+ year history in the beverage industry proves they are trusted keg specialists when it comes to quality and ingenuity.

Schafer SUDEX kegs are plasma-welded, durable stainless steel kegs built to withstand the brewing industry. With stackability, damage-resistant top and bottom chimes, and customizable branding options, Schafer SUDEX kegs are proven to be the leading choice in the beer and beverage industry.

SKU	Description
KGSUD-D20	Stainless Steel Keg, Schafer SUDEX with MicroMatic D Fitting, 20L, Stackable, AISI 304
KGSUD-D30	Stainless Steel Keg, Schafer SUDEX with MicroMatic D Fitting, 30L, Stackable, AISI 304
KGSUD-D50	Stainless Steel Keg, Schafer SUDEX with MicroMatic D Fitting, 50L, Stackable, AISI 304



Stackable kegs will nest on top of one another allowing for kegs to be stored securely



Custom embossing, silk screen printing and etching available with your brewery logo

BREWERY TARGETED PRODUCTS

SCHAFFER KEGS

- European 304 Stainless Steel kegs
- Micromatic or DSI spears
- Stackable for easier storage
- Embossing, silk screen printing and electric corrosion etching options available

Schafer Eco Kegs

SKU	Description
KGECO-D1/6	Stainless Steel ABS Plastic Bottom and Chime Keg, Schafer ECO 20L, Stackable, AISI 304
KGECO-D50	Stainless Steel ABS Plastic Bottom and Chime Keg, Schafer ECO 50L, Stackable, AISI 304

Product Features

- 30% Lighter than Stainless Steel kegs. Lowers shipping costs - saving money in the long run.
- Available with custom branding
- Safety disc installed on all kegs



KGECO-D50

KGECO-D1/6

Bottom and top chimes of ECO kegs are made of polypropylene which make for a lighter keg

Schafer Plus Kegs

SKU	Description
KGPLUS-D20	Schafer Stainless Steel-KEG, Junior PLUS 20L, Stackable
KGPLUS-D50	Schafer Stainless Steel-KEG, PLUS 50L DIN, Stackable

Product Features

- Robust construction ensuring the kegs will look great long into the future.
- Available with custom branding
- Safety discs installed on all kegs



KGPLUS-D50

KGPLUS-D20

BREWERY TARGETED PRODUCTS

SCHAFER TANKS

- European 304 Stainless Steel kegs
- Stackable
- Forklift Channels for Easy Mobility
- Tri-Connect Total Drain System with Top Hatch Configurations

Schafer Tanks

Schafer tanks provide a large-scale quality storage solution for breweries, available in 500L, 800L and 1000L sizes, either jacketed or non-jacketed. Jacketed tanks are most commonly found when a controlled temperature is desired, used in fermentation.

Non-jacketed is lighter weight and used when temperature is not an issue, as the tanks have forklift channels for easy mobility.

***Schafer Tanks available upon request*

Stainless Steel Tanks

SKU	Jacketed	Volume	Height (in.)	Diameter (in.)
500T	No	500L	52.64	39.37
500JT	Yes	500L	52.64	39.37
800T	No	800L	68.62	39.37
800JT	Yes	800L	68.62	39.37
1000T	No	1000L	73.74	39.37
1000JT	Yes	1000L	77.75	39.37

Product Features

- Available in a jacketed version for temperature sensitive applications
- Easily stackable
- Forklift Channels for easy mobility
- Tri-Connect total drain system with top Hatch Configuration
- Overpressure safety valve and CO2 valve



BREWERY TARGETED PRODUCTS

BRANDED TOWERS & MEDALLIONS

- Customize your logo on a tower to display your brand
- Various styles of towers available
- Vinyl wrap or stainless steel design
- Branded or blank fish eye medallions available



Branded Cylinder

Name	SKU	Faucets	Height
3" Cylinder 1, Chrome, AIR	D4743T	1	12"
3" Cylinder 1, Chrome, GLYCOL	D4743TG	1	12"
3" Cylinder 2, Chrome, AIR	D4743DT	2	12"
3" Cylinder 2, Chrome, GLYCOL	D4743DTG	2	12"
3" Cylinder 2, Chrome, GLYCOL LED	D4743DTG-LED	2	12"
3" Cylinder 3, Chrome, AIR	D4743TT	3	14"
3" Cylinder 3, Chrome, GLYCOL	D4743TTG	3	14"



Standard medallion size for all UBC towers is 82mm and is the most common size found in the industry.

Fish Eye Medallions

Name	SKU
3D, acrylic lens, blank, fish eye, 82mm	FE-Medallion
3D, acrylic lens, blank, fish eye, 80mm	FE-Medallion 80
3D, acrylic lens, blank, fish eye, 65mm	FE-Medallion 65

All fish eye medallions can be customized with any logo

Branded Terra

Name	SKU	Faucets	Width	Distance between faucets
Terra 2 BR	Terra 2 Branded	2	9 7/8"	5 1/8"
Terra 3 BR	Terra 3 Branded	3	15 7/8"	5 1/8"
Terra 4 BR	Terra 4 Branded	4	17 1/4"	3 7/8"
Terra 5 BR	Terra 5 Branded	5	26 7/8"	5 1/8"
Terra 6 BR	Terra 6 Branded	6	25"	3 7/8"

Front plate is fully customizable



BREWERY TARGETED PRODUCTS

PEGAS CRAFTAP 3.0

- Counter pressure filler for glass growlers
- No foam
- Less than 2% waste
- Long beer shelf life



GFS-TAP3.0

Pegas CraftTap 3.0

CraftTap uses a unique system that allows the user to determine the amount of foam. Therefore, the user can reduce their waste down to 2-0% while utilizing 98-100% of the product in each keg. The Pegas CraftTap is a manual system that uses a counter pressure filling method, the same operating principle found in large beer bottling factories around the world. This method ensures the bottles are filled in the way that only automatic fillers can provide - without foam and at a rate of two liters in just over sixty seconds.

Features

- Eliminates oxygen
- 30-45 day shelf life
- No foam / no mess
- Less than 2% waste
- Fits several bottle sizes
- Easy operation

Whats New on 3.0?

- Improved pressure release valve
- Improved door latch
- Newly tooled plastic body
- Metal frame connects top to base
- Insulated beer line enclosure
- Improved bottle raising platform
- Back lit POP area on back of unit

CraftTap Kits

SKU	Description
GFS-NP-ASM	Installation Kit for CraftTap
GFS-4P-ASM	Installation Kit for CraftTap and CraftPad 4
GFS-6P-ASM	Installation Kit for CraftTap and CraftPad 6
GFSK-1	CraftTap 1 Year Maintenance Kit

BREWERY TARGETED PRODUCTS

PEGAS CRAFTPAD LITE



- Dispense up to 6 beer brands from your CraftTap
- Two unique designs compatible with Crafttap 3 or Smart
- Whole system is purged after every pour

Pegas CraftPad Light

PEGAS CraftPad Light is the new and advanced multi-dispense system for the PEGAS Crafttap. The PEGAS CraftPad light is created to dispense up to 6 beer brands and other foaming beverages through 1 device. PEGAS has combined the key strengths of PEGAS CraftPad with modern design.

GFS-PADL4 / GFS-PADL6



The CraftPad Light can be installed on any surface

CraftPad Features

- Dispense up to 4 or 6 different beer brands
- Whole system is blown through after every pour
- Can be built into any horizontal or vertical surface
- Extra space to mark beer brands on CraftPad Light
- 30% lighter than the CraftPad
- CraftPad Light can be installed separately from CraftTap



BREWERY TARGETED PRODUCTS

GROWLER FILLING STATION

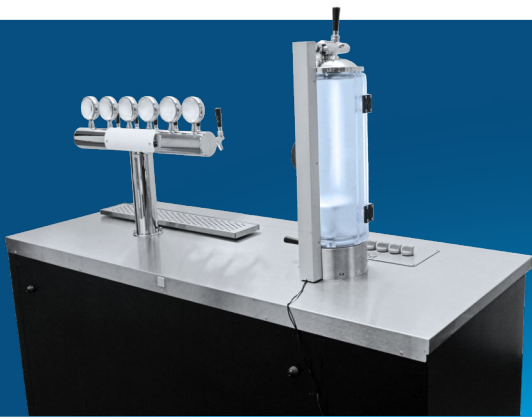

- Growler Filling Stations come in a variety of lengths
- Can be used with growler fillers, towers, etc.
- Great for sampling and pouring



Growler Filling Station

The Growler Filling Station is a great option for filling growlers and sampling beers or pouring pints. You can customize the station to suit your needs. The stations come in a variety of sizes to make it convenient for your location.

- Units come in 58", 68" or 94" length
- Can be used with a variety of different towers
- Can mount Pegas CraftPad or CraftPad Light
- Can store several different kegs for accomodation

ABBC-68-TERRA6+GFS





UBC UMBRELLAS

**NOW AVAILABLE
IN DIFFERENT SIZES &
STYLES!**

- Buy directly from the manufacturer
- Available in either round or square styling
- Delivered faster than most other customized market umbrellas
- Made in Europe by UBC PROMO



BREWERY TARGETED PRODUCTS

Beautiful, highest quality ceramic tap handles. Available in virtually any design to represent your beer in restaurants and bars. All handles are made with the highest quality ceramics, resin and other materials. Our specialized team is happy to work with you on your design and development to completion.



Generic Tap Handles

Name	Colours	Dimensions $W \times D \times H$, mm
A-5	Black, White	58x50x123
A-201	Black, White	62x35x128
A-57	Black, White	75x57x272
A-291	Black, White	80x58x272

UBC keeps generic handles in stock for purchase anytime. We can brand any of these handle options locally as well.

A-5

A-201

A-57

A-291

BREWERY TARGETED PRODUCTS

ILLUMINATED PUB SIGNS

- Variety of shapes and sizes
- Innovative eye-catching design
- Custom branding for breweries, bars and restaurants



BREWERY TARGETED PRODUCTS

BRANDED JOCKEY BOXES

- Cold keg beer anywhere, anytime without electricity
- Option of custom branding
- Ideal for events, tradeshow, etc.



- Available with 50', 70' or 120' coils
- UBC square coils for a better fit
- Quick disconnects for beer lines
- Optional tower for the top of the Jockey Box

Branded Jockey Boxes with Coils

SKU	Faucets	Finishing	Coil Length	Coil O.D.
JB70SS-1	1	Stainless Steel	70'	5/16"
JB120SS-1	1	Stainless Steel	120'	3/8" - 1/4"
JB70SS-2	2	Stainless Steel	2 x 70'	5/16"
JB120SS-2	2	Stainless Steel	2 x 120'	3/8" - 1/4"
JB50SS-3	3	Stainless Steel	3 x 50'	5/16"
JB50SS-4	4	Stainless Steel	4 x 50'	5/16"

Contact us for a free mock up with your design



BREWERY TARGETED PRODUCTS

PATIO UMBRELLAS, CHALKBOARDS

- High wind speed rating
- Ideal for multi-season use
- Fade resistant printing materials
- Available in several shapes and sizes



Available Sizes:

- 1.8m Round Patio Umbrellas
- 3m Round Patio Umbrellas
- 4m Round Patio Umbrellas
- 3x3m Square Patio Umbrellas



UBC BIERGARTEN & PATIO FURNITURE



- Quality European biergarten tables, bench sets, branded patio tables and chairs now available in Canada
- Many different variations of biergarten & patio furniture
- Different materials, different color finishes, legs/frames
- Can be customized locally in Canada



BREWERY TARGETED PRODUCTS

TABLES

- Designed for patios, special events and large venues
- Steel frame construction allows for multi season use
- Branding is easily customizable and tables/chairs available in several different models



Warranty Terms

UBC Group warrants that its products will be free from defects in material and workmanship, under normal use, regular service and preventative maintenance for 1 (one) year as described in the warranty. The warranty period for compressors is 5 (five) years as described below.

PREREQUISITES

This warranty is available to the first end user for equipment purchased from UBC or UBC's authorized dealers. Equipment resold without such authorization will not be covered under this warranty.

All equipment must be properly installed by a professional installer according to guidelines found in the product manuals. In case of more equipment related information needed during the installation, installation party needs to contact UBC. Approved usage conditions for operation must be provided as required in the product manuals (including but not limited to ambient conditions, dedicated power circuit and required clearance).

All equipment must be maintained and cleaned regularly as specified in the product manual. In case of equipment failure customer must contact UBC Group for a repair authorization number before any repairs are made. Warranty claim form must be completed in full and submitted to UBC Group within 1 month of the repair. Furthermore, pictures must be submitted with warranty claim form where applicable. The claim can be denied and/or suspended without picture(s) of the issue. Some products which are not made by UBC Group are warranted by their respective manufacturer; therefore, this Limited Warranty does not apply to such products.

WARRANTY PERIOD

Warranty period is one (1) year from the date of installation but no longer than eighteen (18) months from date of sale. Compressor warranty period is five (5) years from the date of installation or sixty-eight (68) months from the date of sale from UBC Group.

A warranty stub or documents of sale from distributor must be submitted for units not sold directly by UBC Group for warranty to be valid. The Warranty Claim form must be submitted within 1 month of completed repairs for claim to be valid.

WARRANTY COVERAGE

REFRIGERATION UNITS (INCLUDING COMPRESSOR)

If a product is deemed defective by UBC Group within the warranty period described above UBC Group, at its discretion, will either repair or authorize the repair of the product. UBC Group will be responsible for the labor charges according to the Labor Charges segment within the warranty period if all above mentioned prerequisites are satisfied.

UBC Group may also replace the product at its discretion bearing the labor costs for the product replacement

according to the Labor Charges segment. The customer is responsible for the return of the defective part or product to UBC Group for inspection and defect determination. Customer must package the part or product according to the instructions provided by UBC Group before shipping it. UBC Group will cover the shipping costs for the part or product as described in the Shipping segment of this warranty.

COMPRESSOR

Compressors are covered for an additional Parts Only warranty for a period of four (4) years beyond the general coverage described above. Under the additional coverage if a compressor is deemed defective by UBC Group, providing that all of the prerequisites described above are met, it will be exchanged for a new compressor. UBC Group will not cover the labor charges associated with the compressor replacement. It is the responsibility of the customer to return the defective part to UBC Group. The customer must return all parts of compressor and package the part according to the instructions provided by UBC Group before shipping it. UBC Group will cover the shipping costs for the part as described in the Shipping segment of this warranty.

The customer has the option to send the unit to UBC Group for compressor replacement and in this case will be responsible for all shipping charges. There will be no additional charges by UBC Group for the compressor replacement.

DEFECT DETERMINATION

UBC Group is the only body authorized to determine defects. Customers must contact UBC Group to receive authorization for any course of action prior to any repairs. A warranty claim form must be completed and submitted to UBC Group in order to process the claim and authorize any reimbursements. If a repair is made without an authorization number from UBC Group it will not be covered by the warranty and will not be reimbursed.

If a part or product is authorized for return it is for inspection purposes only. It is the sole discretion of UBC Group as to whether or not a credit/refund will be allowed.

UBC Group's determination of defects is final.

For more information on Warranties and Returns, please scan this QR code

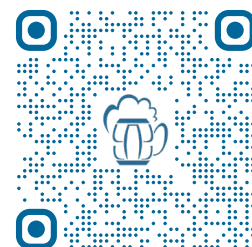

WARRANTY AND RETURN POLICY

Return Policy

RETURNS & SHIPPING

UBC items returned that suffer a product defect during the associated warranty period will be accepted with no restocking fees. All defective UBC parts/equipment will be tested and verified by UBC Technical Service staff before accepting and proceeding with warranty process. During the warranty period UBC Group will be responsible for shipping charges as described in the previous segments.

UBC Group will ship replacement parts using standard ground shipping only, unless previous arrangements are advised by the UBC Sales Representative. Refrigeration units will be shipped on pallets ground freight (LTL), unless previous arrangements are advised by the UBC Sales Representative. If faster replacement shipping is requested, the customer may incur the difference in shipping costs.

RETURN POLICY

UBC items returned that are not covered under any associated warranty, will be processed according to the return policy guidelines below:

- Within 30 days and UBC error or product defect are present, returns are accepted with no restocking fees.
- Within 30 days and there is no UBC error or product defect, returns are accepted with a minimum 15% restocking fee applied to regular products, and minimum 25% restocking fee applied to custom products.
- After 30 days and UBC error or product defect are present, returns are accepted with a minimum 15% restocking fee applied.
- After 30 days and there is no UBC error or product defect, returns will not be accepted.

Please see terms listed at the bottom of UBC 'Packing List' for further details regarding returning products to UBC Group.

RECEIVING MERCHANDISE

1. Shipments received from UBC must be inspected for damage before signing delivery paperwork. If it is not practical to inspect all items at this time, the phrase "Subject to further Inspection" must be written beside the receiver's signature.
2. All items received in the shipment must be thoroughly inspected for damage and accuracy within 48 hours of receipt, and UBC must be notified of any issues within this time.
3. If not notified within 48 hours, the shipment will be considered accepted as complete and without damage.

4. "Drop-shipments" or shipments "to be held for pick-up", will become the receiver's responsibility to have the third-party follow these guidelines on the receiver's behalf.

5. If a shipment shows damage, and the receiver has accepted it without indicating any note on the receipt paperwork, UBC will reject damage claims associated with the shipment.

By signing the carrier's freight bill without any notation of damage, you are agreeing that the shipment was delivered in good condition. Any damage found after that point, should be directed to the freight carrier in the form of a concealed damage claim.

UBC Group is not responsible for freight damage claimed once the shipment was signed for as received in good condition. UBC Group's responsibility ceases upon the shipment's acceptance by the recipient.

PRODUCT DELIVERY

The customer is responsible for inspecting units upon receipt for concealed damage caused during shipping. The customer must report damaged/non-working units or components to UBC Group immediately. Deliveries with physical damage should be denied. A claim must be filed with the carrier for any damages that occur during shipping. UBC Group is not responsible for units damaged during shipping.

SHIPPING

Most orders are shipped within 1 to 2 business days via a preferred shipping company. All goods are shipped from our central warehouse at 1143 Haultain Court, Mississauga, Ontario. Shipments are FOB Origin with freight charges prepaid and billed. The shipping charges will be added to the invoice.

Some heavy or large items must be shipped LTL Freight. Freight carrier delivery is to back of truck and does not include carrying the item into the building, unpacking or lift gate service to unload the shipment. If a dock or forklift is not available, lift gate service is available for an additional charge. Deliveries are made Monday thru Friday, excluding holidays.



Index

Air Distributors	87	Wall Brackets	102
Arcadia	24 - 26	90 Tail Pieces	102
Back Bar Coolers		Gear Clamps	102
CoolBar BB-100	120	Crosses	102
Large Back Bar Coolers	121-122	U-Bends	102
Bottle Water Dispensers	80	Hose Plugs	102
Carbonator Coolers	78	Coil Fittings	102
Carbonators	79	Flash Coolers	71
Ceramic Towers	49	FOBS	
Chalkboards	147	FOB Controllers	97
CO2 Tanks	112	Fittings	97
Coils	124	Gas Blenders	88
Cold Plates		Gefest Tower	18
Cold Plates	124	Glycol	67, 130
Cold Plate Fittings	124	Glycol Power Packs	64-69
Connectors	80	Growler Fillers, PEGAS	
Cylinder Towers	34	CrafTap 3.0	140
Cylinder Towers	34	CraftPad Lite	141
Cylinder Towers Branded	139	Filling Station	142
Double Pedestal Towers	40	ICE Towers	
Drip Trays		TOF Towers	47
Countertop	59	Arcadia Towers	47
Platform	60	Illuminated Signs	145
Wall Mount	61	Indie	20
Parts	61	In-line Leak Indicators	88
Clamp On	62	In-Line Regulators	79
Faucets		JG Towers	23
Domestic Faucets	53	Jockey Boxes	
Stout Faucets	55	With Coils	125
Stout Faucet Parts	55	With Towers	126
Euro Flow Control	55	With Branding	146
Accessories	57	Tapping Kits	127
Fittings		DIY Kits	127
Elbow Splicers	101	John Guest Fittings	
Y-Fittings	101	Superseals	98
Stepless Clamps	101	Reducers	98
Splicers & Reducers	101	Shut-offs	98
T-Fittings	101	CPC Fittings	99
Tail Pieces	101	BSPP	99
Cold Plate Fittings	102	Bulkheads	99

Index

Locking Clips	99	Pumps & Motors	
Tees	99	Rotary Vane Pumps & Motors	91
Stems	100	Pump Parts	91
Dividers	100	Vertical Agitator Pump	91
Connectors	100	Beer Pump	91
Keg Couplers		Refrigerators	
UBC	94	IceStream Smart Cool	116
MicroMatic	95	IceStream Optima	117
Accessories	95	IceStream Super Large	118
Parts	96	Regulator Panels	89
Kegerators		Regulators	
Large Kegerators	111	Primary CO2 Regulators	84
Kegbar BB100	110	Primary Nitrogen Regulators	84
Kegmaster 2	107	Secondary Regulators	85
Kegmaster Eco	108	Regulator Parts	86
Kegmaster Craft	109	Shanks	
Accessories	112	Shanks	56
Kegs		Shank Parts	57
Kegs	92	Tables	149
Keg Caps	93	Tap Handles	144
Keg Accessories	93	Tape	104
Keg Spears & Parts	93	Tee Box Towers	39
Large Diameter Towers		Terra Towers	28
4" Bridge	32	Thermostats	130
4" Arcadia XL	32	Trunkline	103
4" Norma Pass Thru	33	Tubing	
4" UBC Metro	32	Insulation Tubes	104
Line Cleaning		Thermoplastic Vinyl Hose	105
Cleaning Kits	131	Braided Vinyl Hose	105
Accessories	131	Bev-Seal Ultra Beverage Tubing	105
Cleaning Valves	132	Polyethylene Hose	105
Cleaning Cans	132	Accessories	104
Cleaning Caps	133	Umbrellas, Patios	149
Line Cleaners	133	Under Bar Dispenser Towers	41
Medallions		Venus Towers	46
Milano Towers	44	Vice Tower	19
Party Pumps	124	Wall Mount Dispenser Towers	41
Persey Tower	21	Wall Mount Growler Drip Tray	42
Pumps		Water Filtration	80
FloJet Pumps	79	Wine-on-tap Coolers	82
Pump Fittings	79	Wrenches	130
		Yukon Towers	34



UBC GROUP CANADA - EAST

1143 Haultain Court,
Mississauga, ON, L4W 2K1

Phone: 905 629 2597
Toll Free: 866 995 9965
Fax: 905 629 2577
Email: info@beer-co.ca

UBC GROUP CANADA - WEST

18860 24 Ave Unit 127
Surrey, BC, V3Z 0Y8

Phone: 604 529 6000
Toll Free: 877 789 4221

