



UBC
group

TAP HANDLES

• catalog



UBC Tap Handles

Since 1998, UBC Ceramics has helped breweries around the world increase beer sales by making their brands stand out in a bar setting. This is achieved by manufacturing a wide variety of custom and generic tap handle shapes based upon our customers' specific needs and wants. Initially starting out as a ceramic beer tower manufacturer, we have quickly progressed into one of the world's most dynamic tap handle design and production companies. Our ceramic tap handles are produced in Ukraine using environmentally friendly materials and technologies originally developed in Germany by ceramic beer stein manufacturers. With any tap handle purchase, UBC Ceramics will provide complimentary custom design and development assistance. Our specialized team will work with you to come up with interesting designs, and we offer 3D images before initial samples are created. We look forward to working with you on your next tap handle project!

The UBC Team

CERAMIC TAP HANDLES



A-1



A-2



A-3



A-4



A-5



A-6

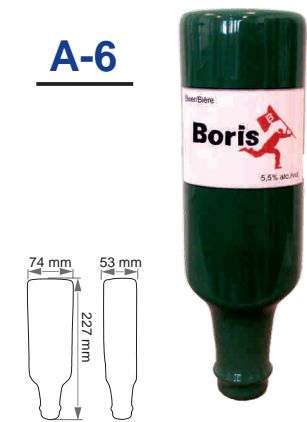

A-7

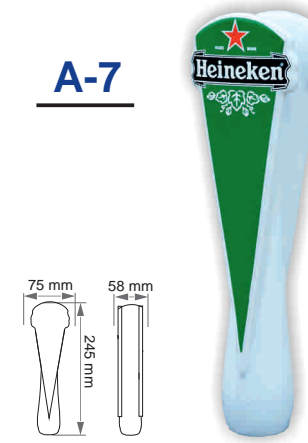

A-8

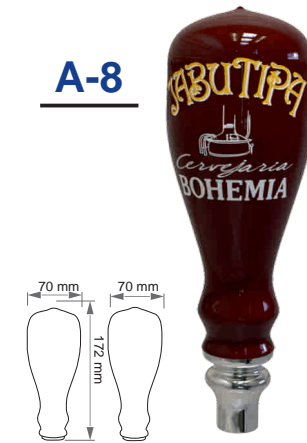

A-9

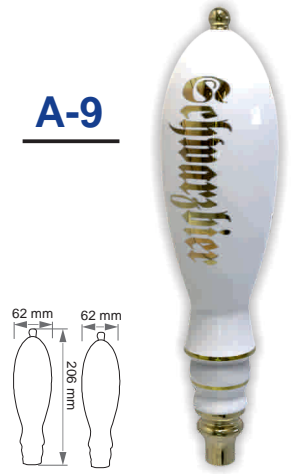

A-10

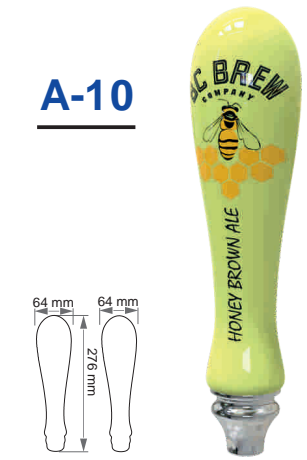

A-11



A-12



A-13



A-14



A-15



A-16



CERAMIC TAP HANDLES

A-17

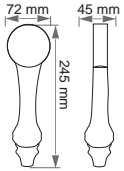

A-18

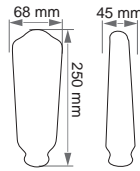

A-19

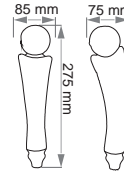

A-20

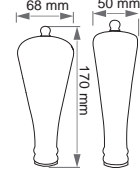

A-21

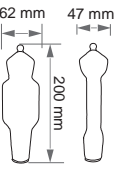

A-22

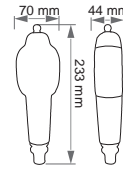

A-23

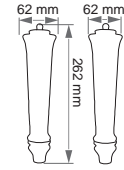

A-24

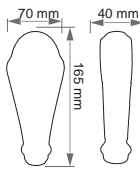

A-25

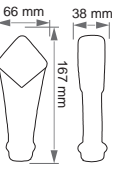

A-26

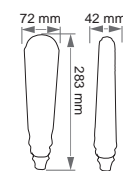

A-27

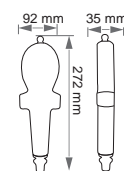

A-28

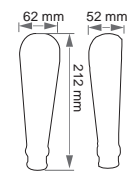

A-29

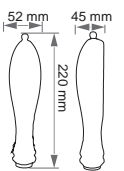

A-30

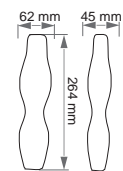

A-31

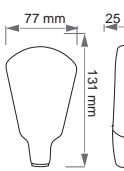

A-32

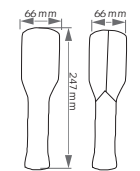

A-33

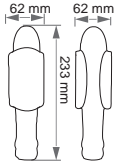

A-34

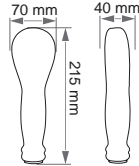

A-35

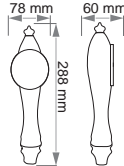

A-36

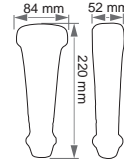

A-37

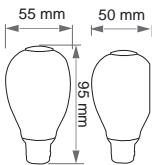

A-38

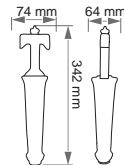

A-39

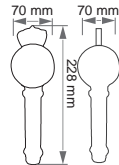

A-40

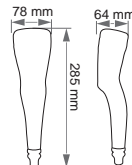

A-41

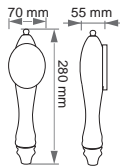

A-42

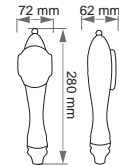

A-43

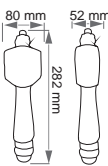

A-44

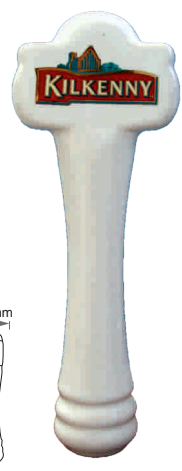
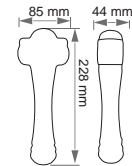

A-45

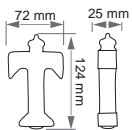

A-46

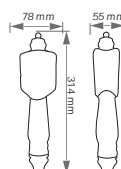

A-47

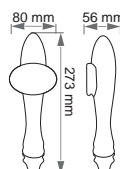

A-48

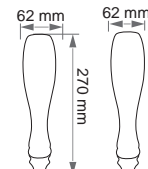

CERAMIC TAP HANDLES

A-49

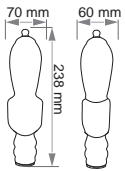

A-50

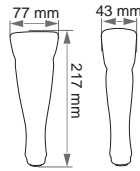

A-51

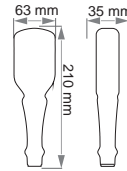

A-52

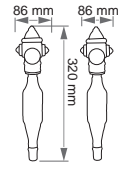

A-53

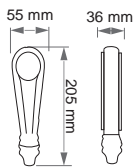

A-54

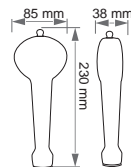

A-55

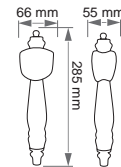

A-56

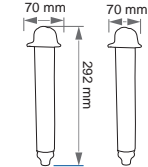

A-57

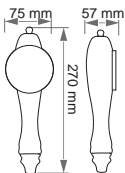

A-58

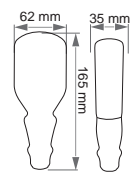

A-59

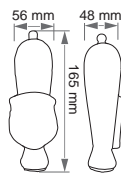

A-60

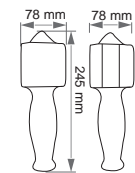

A-61

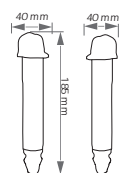

A-62

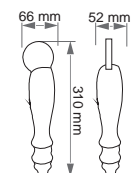

A-63

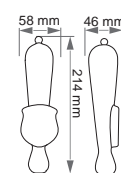

A-64

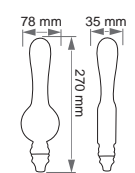

A-65

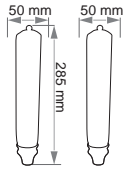

A-66

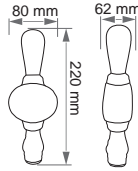

A-67

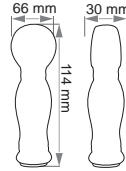

A-68

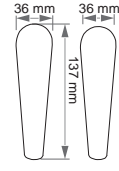

A-69

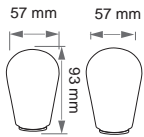

A-70

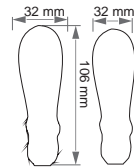

A-71

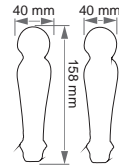

A-72

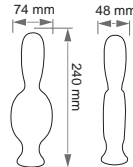

A-73

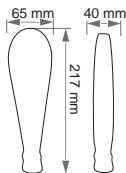

A-74

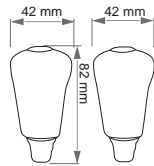

A-75

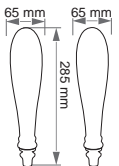

A-76

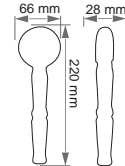

A-77

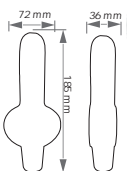

A-78

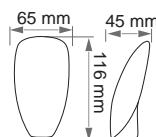

A-79

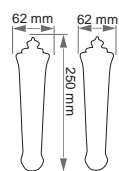

A-80

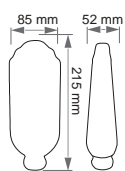

CERAMIC TAP HANDLES

A-81

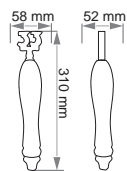

A-82

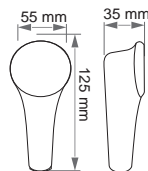

A-83

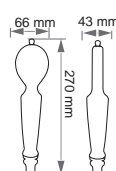

A-84

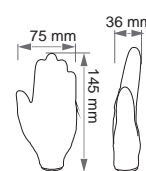

A-85

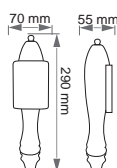

A-86

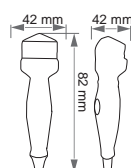

A-87

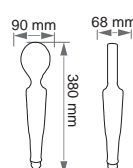

A-88

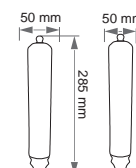

A-89

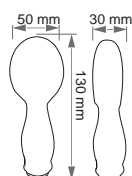

A-90

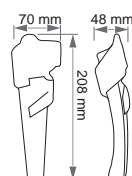

A-91

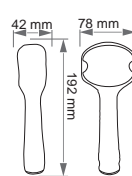

A-92

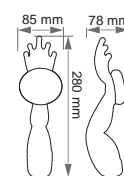

A-93

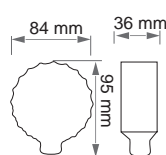

A-94

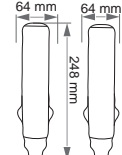

A-95

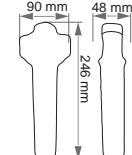

A-96

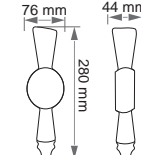

A-97

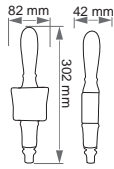

A-98

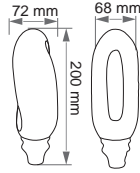

A-99

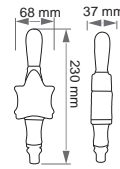

A-100

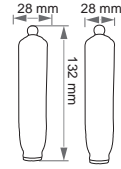

A-101

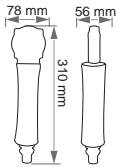

A-102

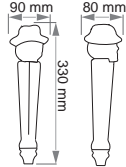

A-103

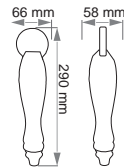

A-104

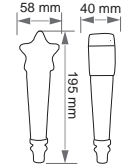

A-105

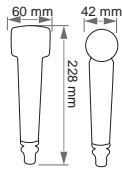

A-106

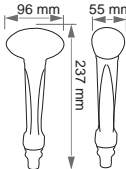

A-107

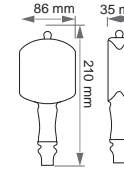

A-108

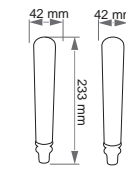

A-109

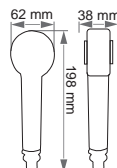

A-110

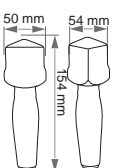

A-111

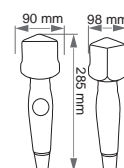

A-112

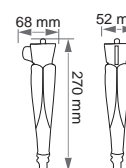

CERAMIC TAP HANDLES

A-113

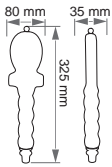

A-114

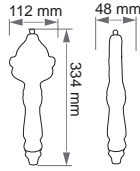

A-115

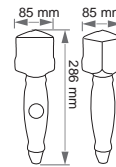

A-116

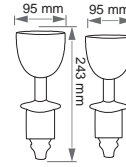

A-117

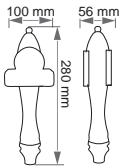

A-118

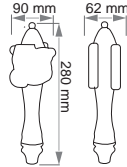

A-119

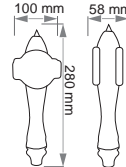

A-120

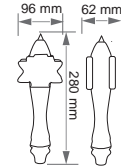

A-121

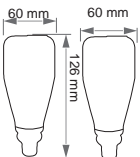

A-122

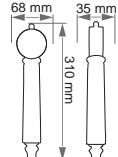

A-123

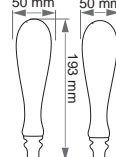

A-124

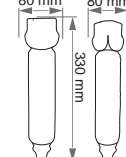

A-125

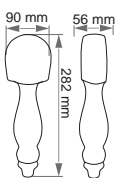

A-126

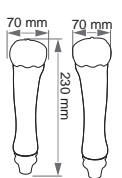

A-127

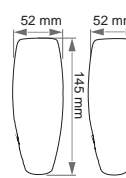

A-128

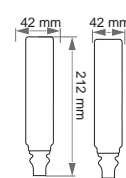

A-129

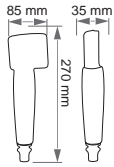

A-130

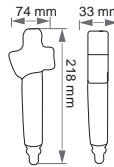

A-131

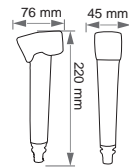

A-132

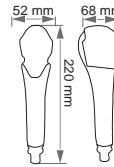

A-133

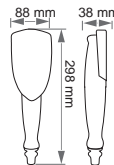

A-134

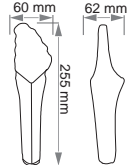

A-135

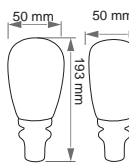

A-136

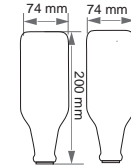

A-137

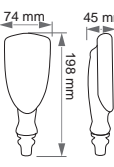

A-138

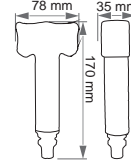

A-139

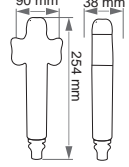

A-140

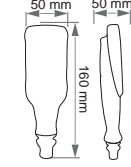

A-141

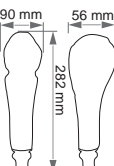

A-142

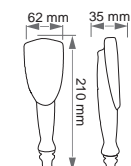

A-143

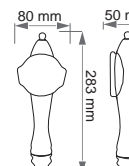

A-144

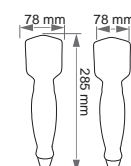

CERAMIC TAP HANDLES

A-145

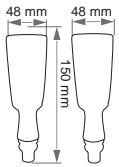

A-146

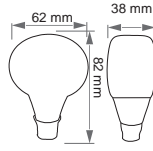

A-147

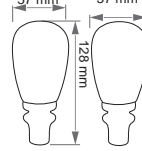

A-148



A-149

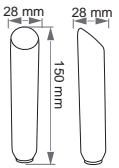

A-150

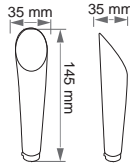

A-151

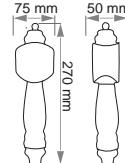

A-152

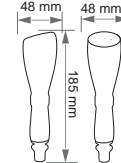

A-153

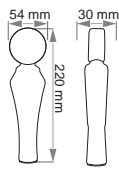

A-154

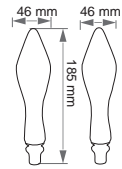

A-155

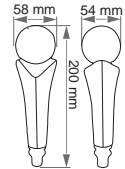

A-156

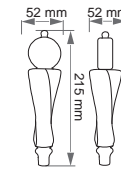

A-157

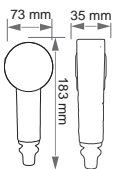

A-158

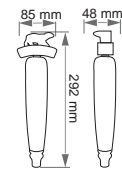

A-159

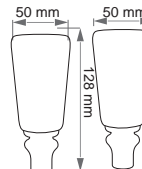

A-160

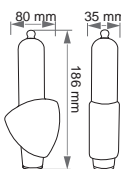

A-161



A-162



A-163

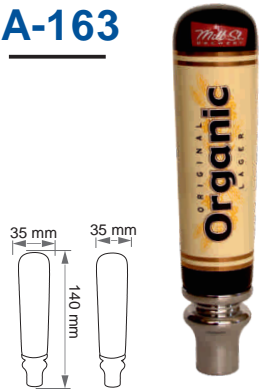

A-164



A-165



A-166

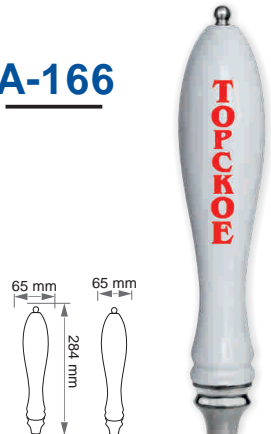

A-167

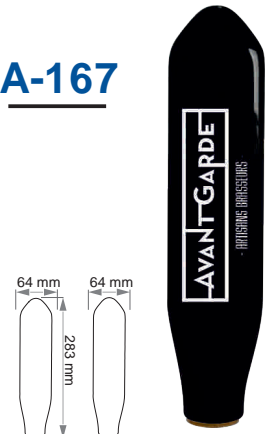

A-168



A-169



A-170



A-171



A-172



A-173



A-174

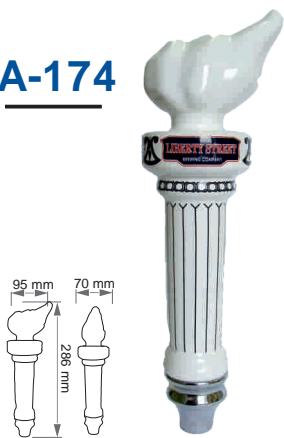

A-175



A-176

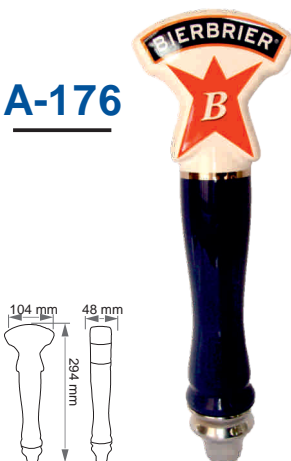

CERAMIC TAP HANDLES

A-177

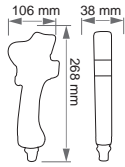

A-178/A

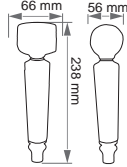

A-178/B

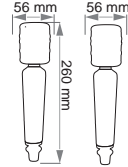

A-179

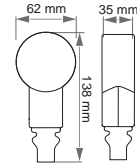

A-180

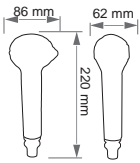

A-181
concept

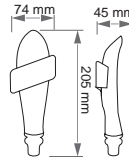

A-182/A

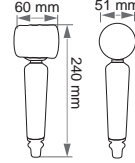

A-182/B

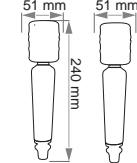

A-183
concept

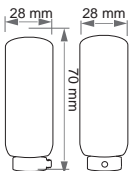

A-184

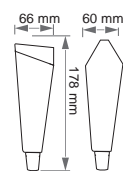

A-185

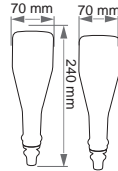

A-186

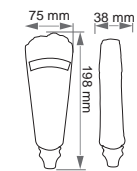

A-187

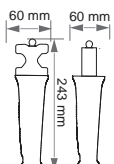

A-190
concept

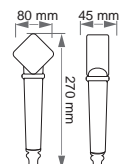

A-191

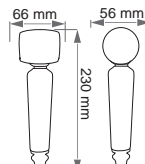

A-192

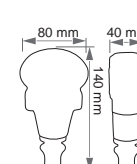

A-193

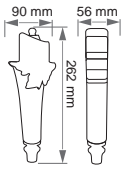

A-194
concept

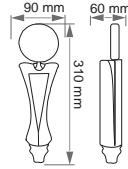

A-196
concept

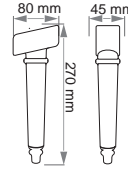

A-197

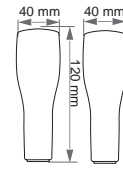

A-198

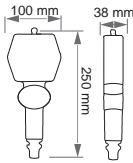

A-199

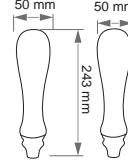

A-200

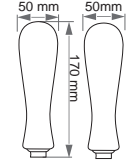

A-201

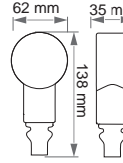

A-202

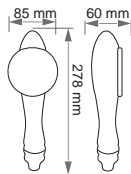

A-203

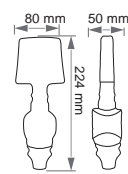

A-204

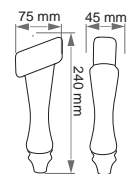

A-205

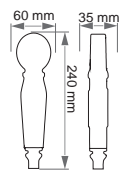

A-206
concept

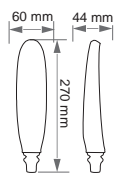

A-207

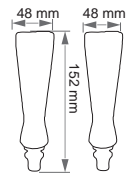

A-208

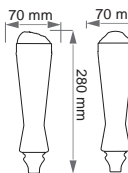

A-209

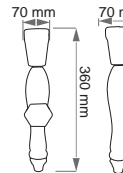

CERAMIC TAP HANDLES

A-210

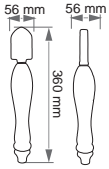

A-210/B

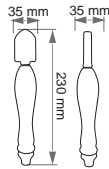

A-211

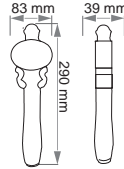

A-212

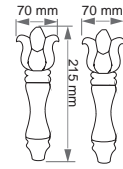

A-213

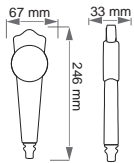

A-214

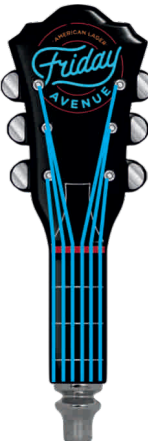
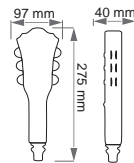

A-217

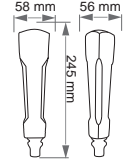

A-219

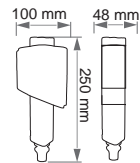

A-220

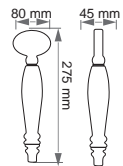

A-221

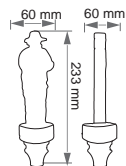

A-222

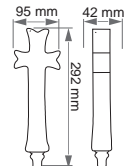

A-223

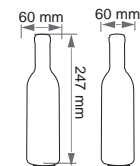

A-225

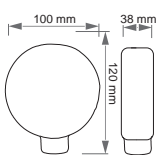

A-226

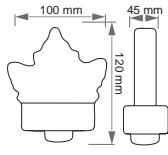

A-227

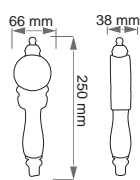

A-228/B

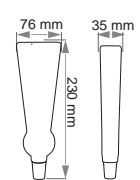

A-228/C

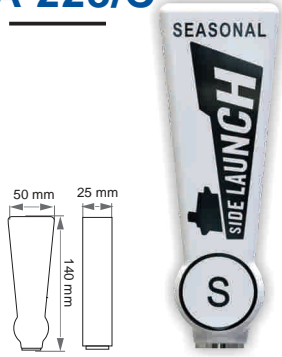

A-229
concept



A-230



A-231



A-232
concept



A-233
concept



A-234



A-235
concept



A-236

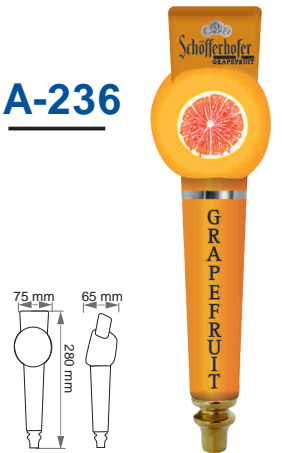

A-237
concept



A-238
concept



A-240
concept



A-241
concept



A-242
concept



A-244
concept



A-246

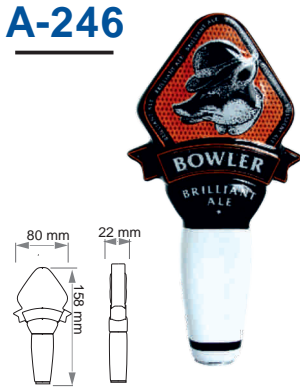

CERAMIC TAP HANDLES

A-247

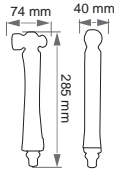

A-248
concept

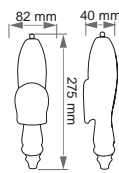

A-249

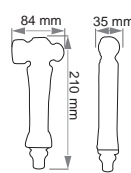

A-251

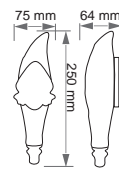

A-252

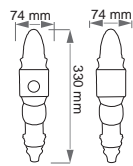

A-253

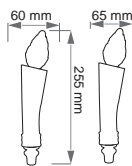

A-256
concept

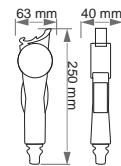

A-257

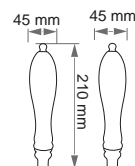

A-262

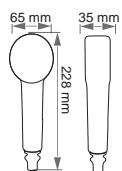

A-264

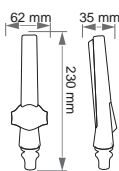

A-265

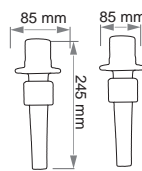

A-268

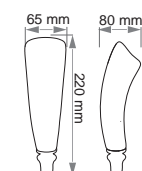

A-270
concept

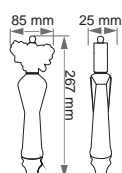

A-271

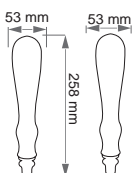

A-272

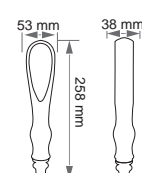

A-273

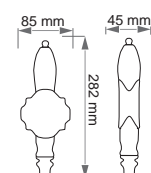

A-274

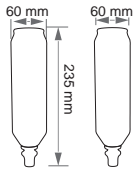

A-275
concept

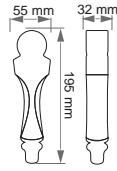

A-276
concept

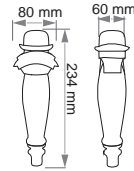

A-277

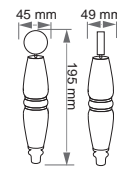

A-278

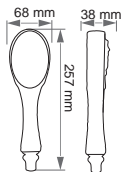

A-279

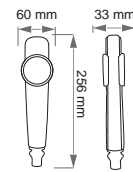

A-280

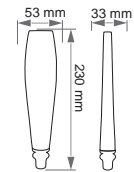

A-281

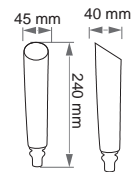

A-282

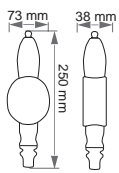

A-283

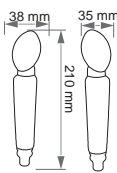

A-284

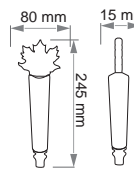

A-285

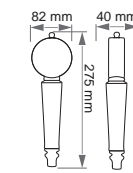

A-286
concept

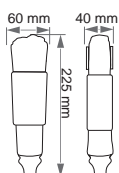

A-287

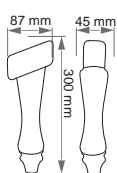

A-288
concept

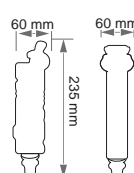

A-289
concept

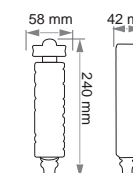

CERAMIC TAP HANDLES

A-291

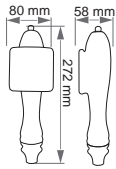

A-294
concept

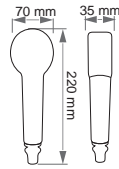

A-295
concept

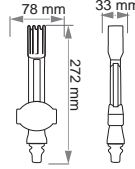

A-298

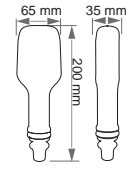

A-300

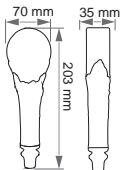

A-302

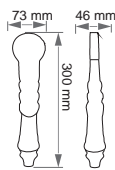

A-303
concept

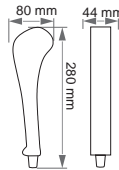

A-304
concept

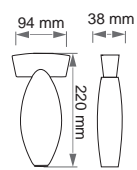
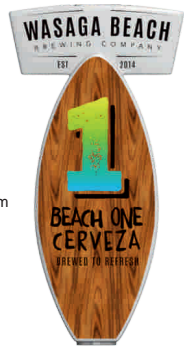

A-305
concept

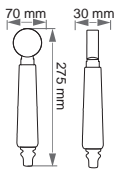
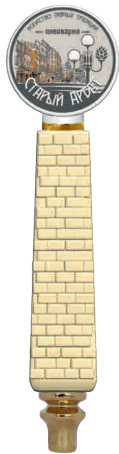

A-306
concept

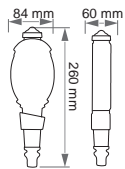

A-308

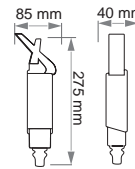

A-309

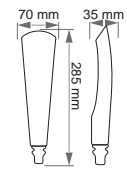

A-312

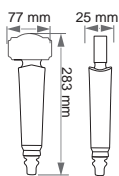

A-313

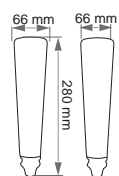

A-314

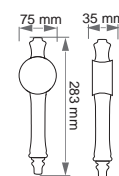

A-315
concept

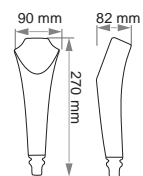

A-316
concept



A-317
concept



A-318
concept



A-319

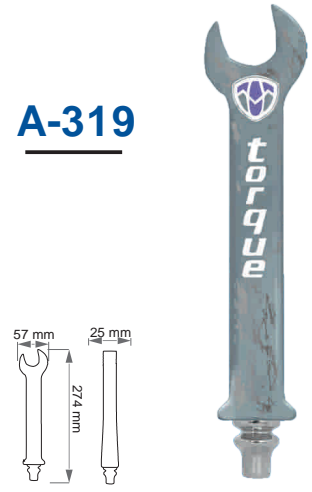

A-320

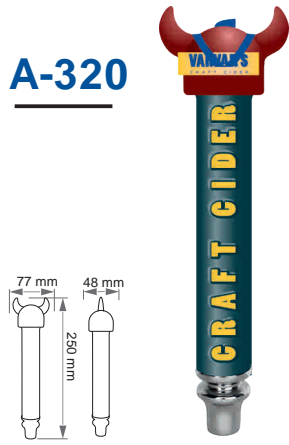

A-321

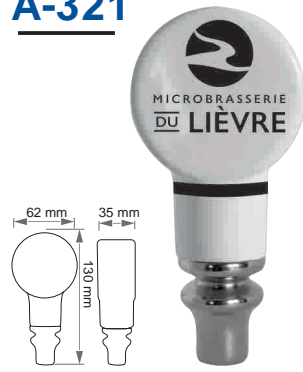

A-323



A-325



A-326
concept

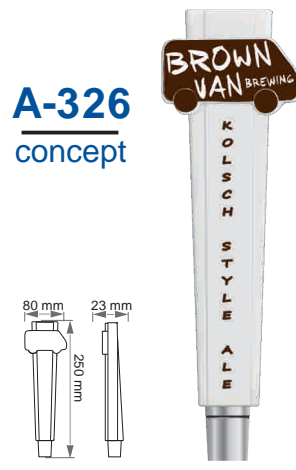

A-327

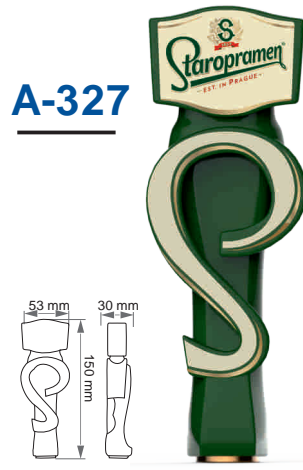

A-328
concept



A-329
concept



A-330
concept



A-332



A-336



A-339



CERAMIC TAP HANDLES

A-341

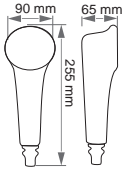

A-342
concept

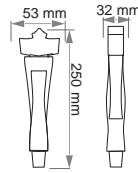

A-343
concept

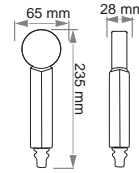

A-344

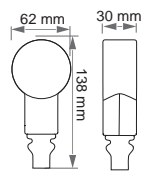

A-345

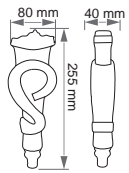

A-347

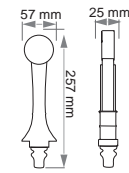

A-348
concept

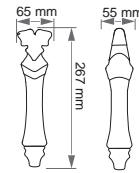

A-354
concept

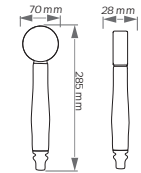

A-359

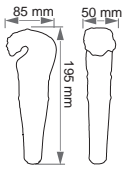

A-361
concept

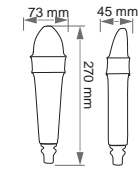

A-401

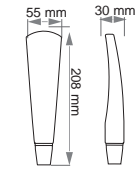

A-402

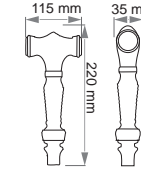

A-404

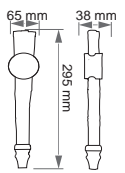

A-405

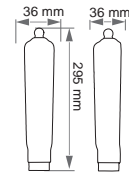

A-406
concept

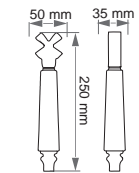

A-407
concept

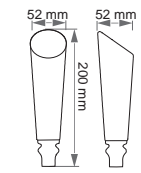

A-408
concept

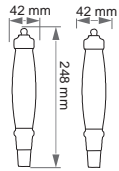

A-409
concept

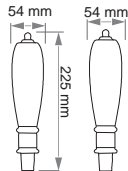

A-410
concept

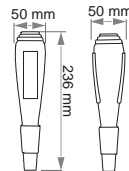

A-411

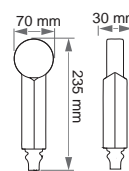

A-412
concept

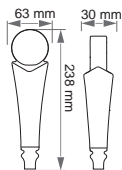

A-413

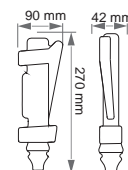

A-414

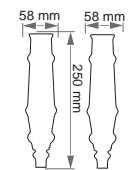

A-415
concept

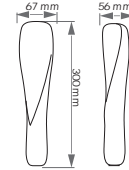

A-417
concept

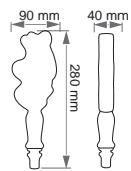

A-418
concept

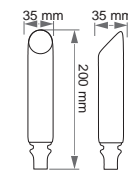

A-419
concept

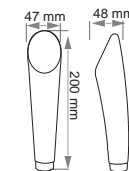

A-420

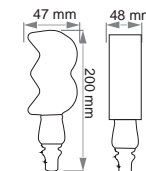

A-421

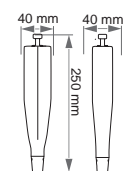

A-423

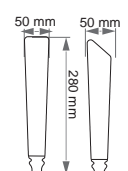

A-424
concept

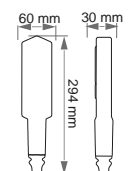

A-425

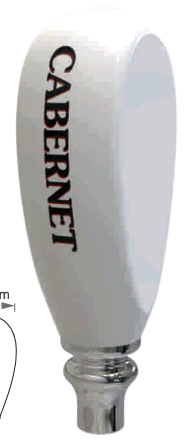
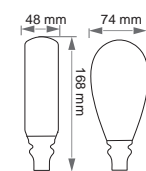

CERAMIC TAP HANDLES

A-426



A-427

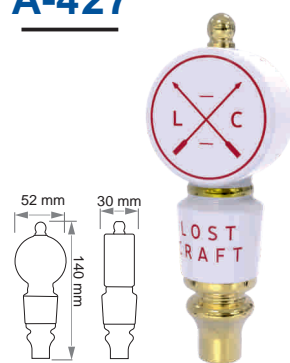

A-428
concept



A-429
concept



A-430
concept



A-431



A-433
concept



A-434
concept



A-435
concept



A-436
concept



A-437
concept



A-438



A-439
concept



A-440
concept

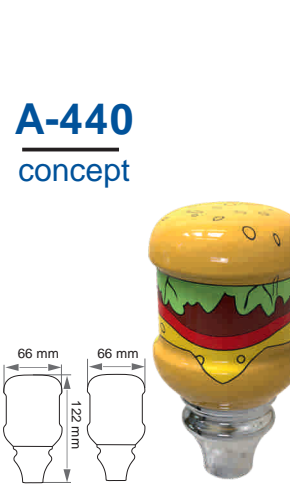

A-441
concept



A-442
concept



WOODEN TAP HANDLES



WOODEN TAP HANDLES

WD-1



WD-2



WD-3/A

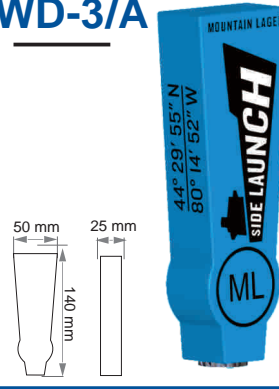

WD-3/B



WD-4



WD-5

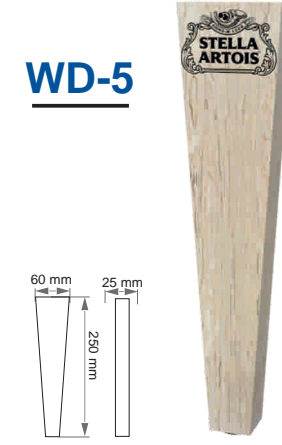

WD-6



WD-7

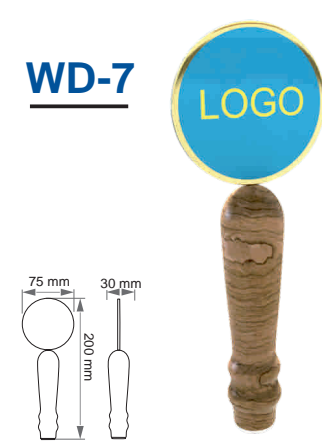

WD-8



WD-9

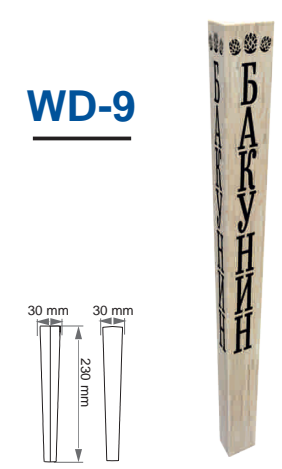

WD-10

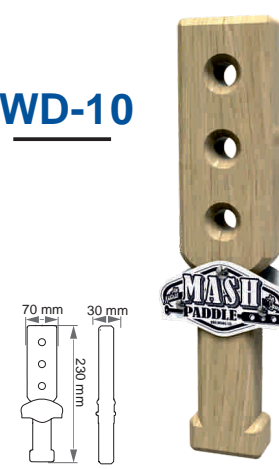

WD-11

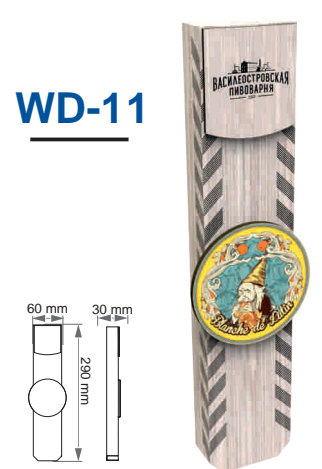

WD-12



WD-13
concept



WD-14



WD-15
concept



WD-17
concept

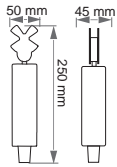

WD-19
concept

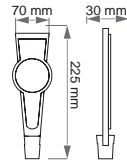

WD-20
concept

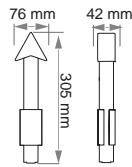

WD-23

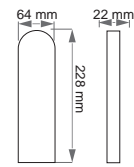

WD-24
concept

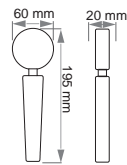

WD-25
concept

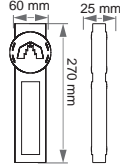

WD-26
concept

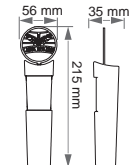

WD-27
concept

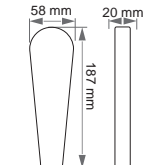

UBC
group



UBC GROUP OFFICES USA/CANADA

65 NORTH CENTRAL DRIVE
OFALLOM MD 63366
USA
TEL: +1(636) 379-2226
FAX: +1(866) 659-8904
TOLL-FREE: +1(888) 808-9286
EMAIL: info@beer-cous
www.beer-cous

1143 HALTAIN COURT,
MISSISSAUGA ON L4W2K1
CANADA
TEL: +1(905) 629-2597
FAX: +1(905) 629-2577
TOLL-FREE: +1(866) 995-9965
EMAIL: info@beer-coca
www.beer-coca