

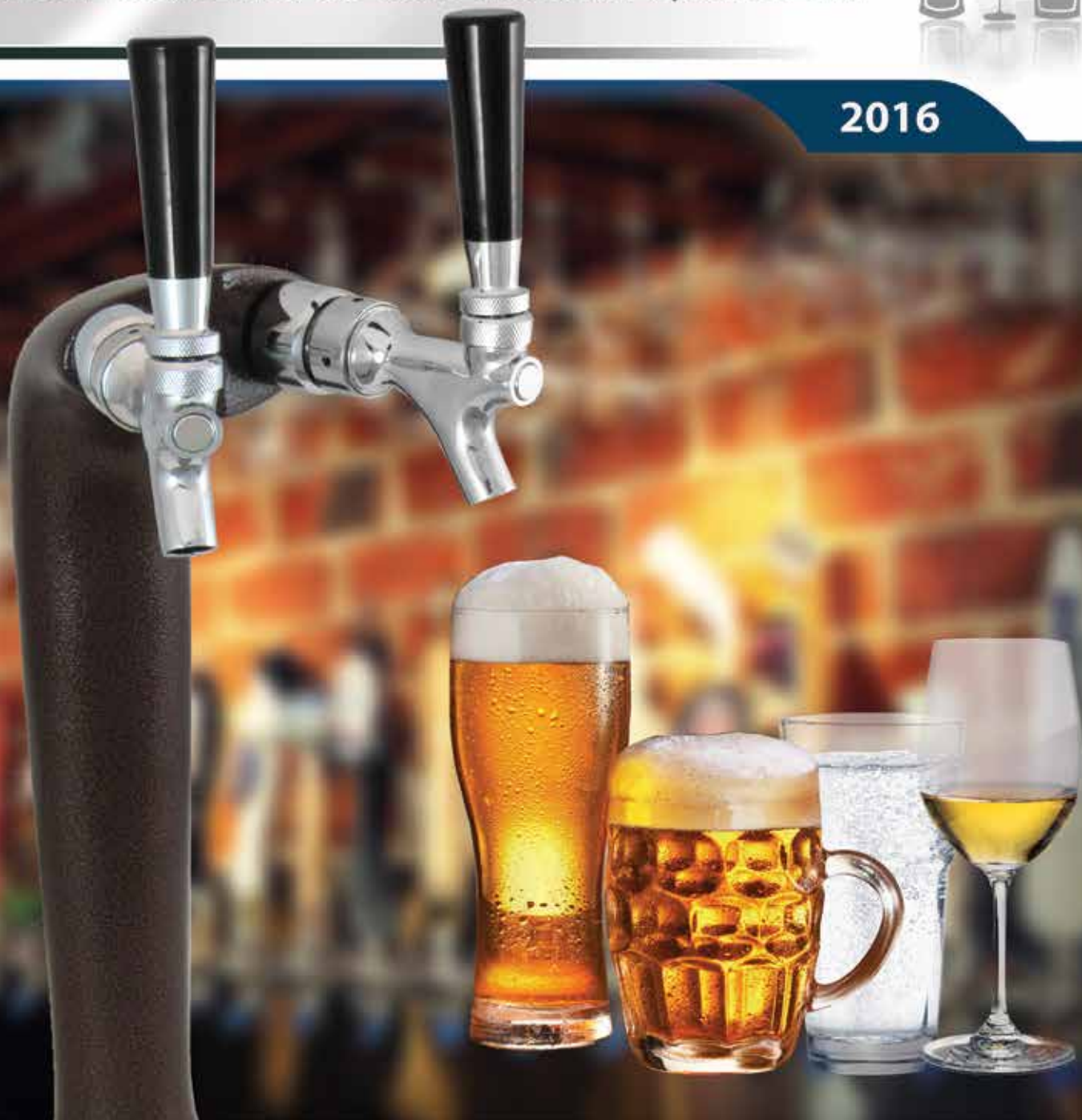

**BEVERAGE COOLING & DISPENSING EQUIPMENT**



**2016**



BEER TOWER PORTFOLIO



GEFEST



VICE

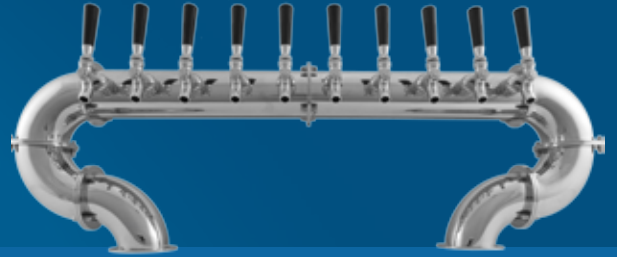

JG



MILANO

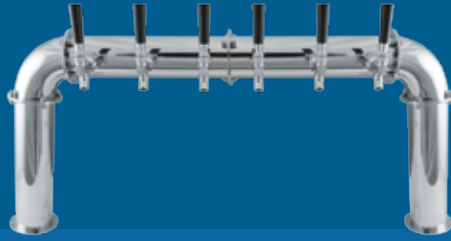

ARCADIA



TERRA

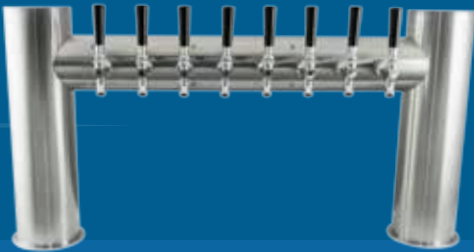

ARCH

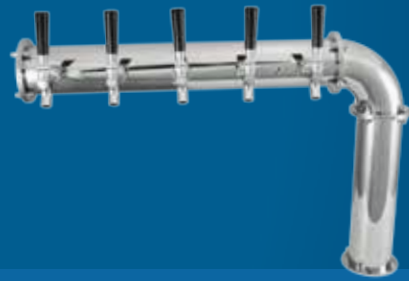

PERSEY



CYLINDER



PONTE

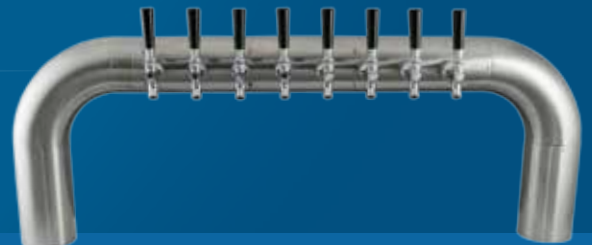

BRIDGE



SUN



YUKON



TEE BOX



**GOTHIC**



**WALL MOUNT**



**UNDER BAR**



**DOUBLE PEDESTAL**



**COBRA**



**INDIE**



**TOF**



**ARCADIA**



**CERAMIC**



**VENUS**

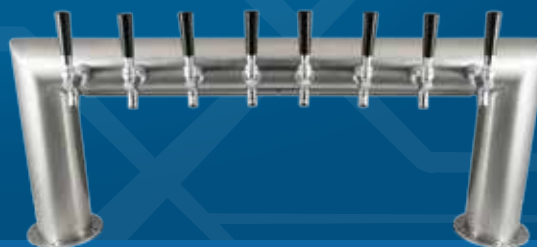

**PASS THRU**



# TOWER COLOR PORTFOLIO

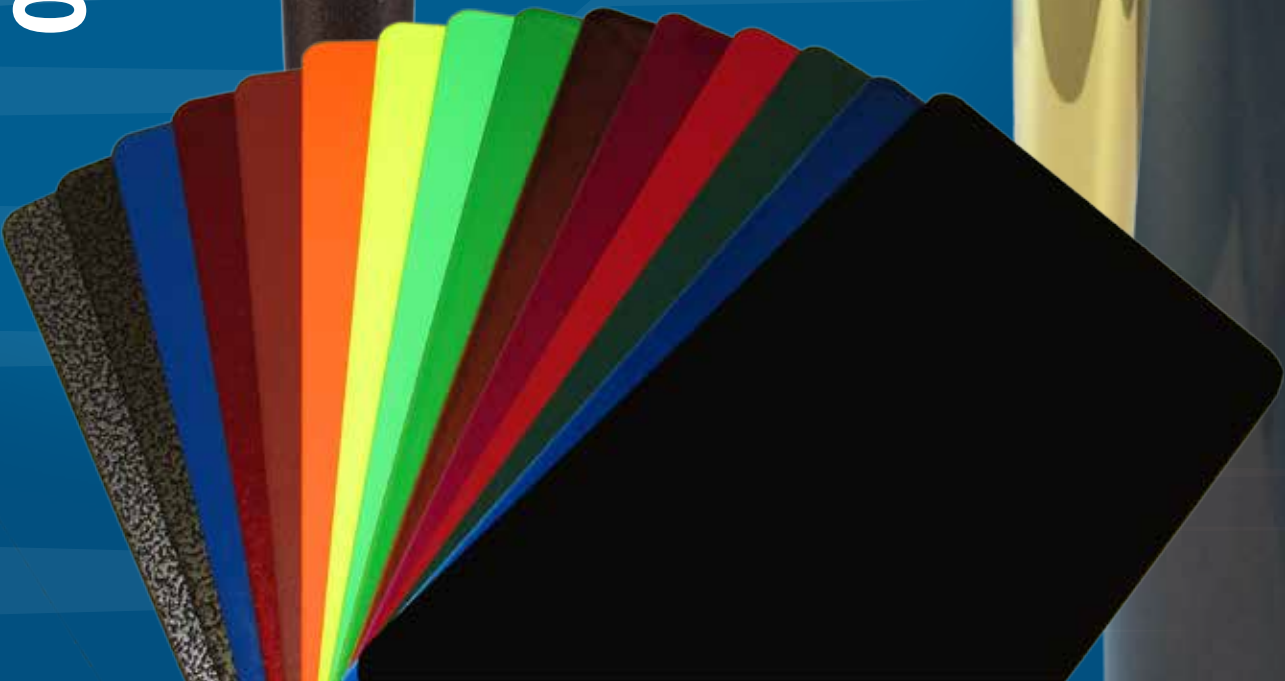

# 2016 PRODUCT HIGHLIGHTS

- PEGAS CraTap, PEGAS Dragon, PEGAS Evolution
- Custom Branded Kegs - 5L, 10L, 20L, 30L, 50L
- New Colors for Draught Beer Towers

**NEW**



## GROWLER FILLERS & ACCESSORIES

- PEGAS Growler Filler, CraTap  
Page: 112
- Pegas CraftPad / Pegas CraftPad Light  
Page: 113, 114
- Growler Filling Station  
Page: 115
- Growler Washing Machine  
Page: 116



## STAINLESS STEEL STACKABLE KEGS

- 304 Stainless Steel
- 5L, 10L, 20L, 30L, 50L, 58L
- Stackable and Non-stackable
- Custom Embossing
- Full Line of Accessories

PAGE: 65, 66, 111

## DRAUGHT BEER TOWER COLORS

- Full Line of Colors for Beer Towers
- Customizable Colors
- Can be Applied to Majority of Towers

PAGE: 4

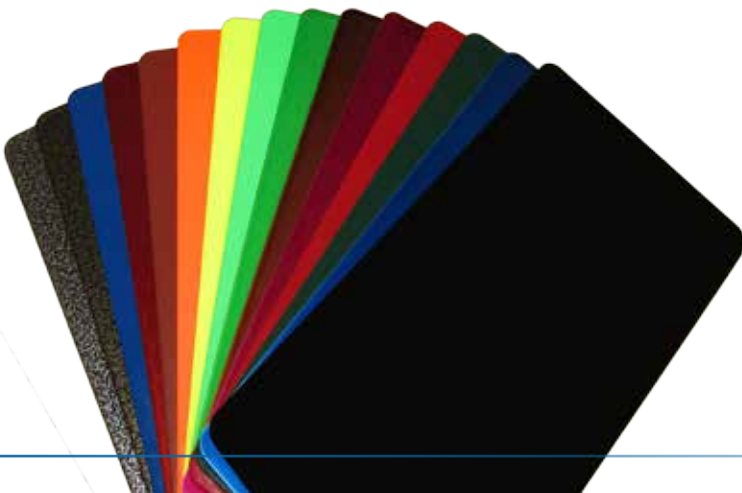



## STAINLESS STEEL TOWERS

- **Gefest/SUN Towers** ..... 11
- **The Vice Towers** ..... 12
- **Indie Towers** ..... 13
- **Persey Towers** ..... 14
- **Arcadia Towers** ..... 16
- **Terra Towers** ..... 19
- **JG Towers** ..... 22
- **Large Diameter Towers** ..... 23
- **Yukon Towers** ..... 24
- **Xenia Towers** ..... 26
- **Milano Towers** ..... 27
- **Gothic / Venus Towers** ..... 28
- **Ponte Towers** ..... 29



## AMERICAN STYLE TOWERS

- **Cylinder Towers** ..... 31
- **Tee Box Towers** ..... 32
- **Double Pedestal Towers** ..... 33
- **Wall Mount & Under Bar Dispensers** ... 34
- 



## ICE TOWERS

- **TOF / Arcadia ICE Towers** ..... 36
- **Cobra ICE Towers** ..... 37



## CERAMIC TOWERS

- **Ceramic Towers** ..... 38



## FAUCETS AND SHANKS

- **Shanks & Parts** ..... 40
- **Faucets** ..... 43
- **Faucet Accessories** ..... 44

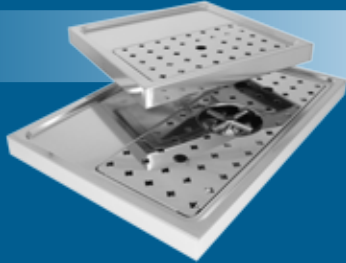

## DRIP TRAYS

- **Countertop** Drip Trays ..... 46
- **Platform** Drip Trays ..... 47
- **Wall Mount** Drip Trays ..... 48
- **Drip Tray** Parts ..... 48
- **Clamp-on** Drip Trays ..... 49



## GLYCOL POWER PACKS

- **Glycol** Power Packs ..... 50



## DRAUGHT BEER ICE BANK FLASH COOLERS

- **Flash** Coolers ..... 54



## BEVERAGE COOLING & DISPENSING

- **Beverage and Carbonator** Coolers ..... 59
- **Beverage System** Parts ..... 60



## WINE-ON-TAP SYSTEMS

- **Wine-on-tap** ..... 62



## DRAUGHT BEER DISPENSE SYSTEM COMPONENTS

- **Kege**s and Accessories ..... 65
- **Primary** Gas Regulators ..... 67
- **Secondary** Gas Regulators ..... 68
- **Regulator Parts** & Air Distributors ..... 69
- **Regulator Panels** & Assemblies ..... 71
- **Gas Blenders** ..... 73
- **Pumps** & Motors ..... 74
- **Kege** Couplers & Parts ..... 75
- **Draught Beer System** Parts ..... 78
- **John Guest** Fittings ..... 79
- **Fittings** ..... 82
- **Trunkline** and Tubing ..... 84

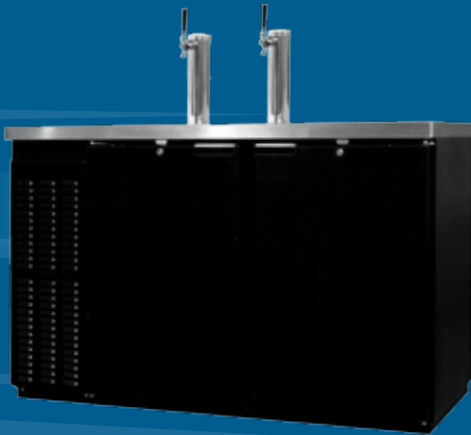

## KEGERATORS

- **Large** Kegerators ..... 88
- **Kege**Bar BB-100 ..... 89
- **Kege**master 2 ..... 90
- **Kege**erator Accessories ..... 91



## REACH-IN REFRIGERATORS

- **Smart Cool 350** ..... 93
- **IceStream OPTIMA** ..... 94
- **IceStream SUPER LARGE** ..... 95





## BACK BAR COOLERS

- **CoolBar BB-100** ..... 97
- **Large Back Bar Coolers** ..... 98



## MOBILE AND EVENT BEER COOLING & DISPENSING

- **Mobile Dispense Parts** ..... 101
- **Jockey Box Picnic Coolers** ..... 102



## INSTALLATION AND MAINTENANCE TOOLS

- **Tools and Accessories** ..... 105
- **Beer Line Cleaning Equipment** ..... 106



## BREWERY TARGETED PRODUCTS

- **Cylinder Branded Towers** ..... 110
- **Kegs** ..... 111
- **PEGAS CrafTap** ..... 112
- **PEGAS CrafPad** ..... 113
- **PEGAS CrafPad Light** ..... 114
- **Growler Filling Station** ..... 115
- **Growler Washing Station** ..... 116
- **PEGAS Evolution Faucet** ..... 117
- **Craft Beer Dispensing Station** ..... 118
- **Ceramic Tap Handles** ..... 119
- **Illuminated Pub Signs** ..... 120
- **Jockey Boxes** ..... 121
- **Patio Umbrellas / Chalkboards** ..... 122
- **Tables** ..... 123

## WARRANTY AND RETURN POLICY & INDEX

- **Warranty and Return Policy** ..... 124

# STAINLESS STEEL TOWERS



## Stainless Steel Towers

- High Quality Polished Stainless Steel
- Chrome, Gold, Copper and custom finishing available
- Optional branded LED and non-LED medallions
- Custom made Branded Ceramic Tap Handles available

■ <b>Gefest/SUN Towers</b> .....	11
■ <b>The VICE Towers</b> .....	12
■ <b>Indie Towers</b> .....	13
■ <b>Persey Towers</b> .....	14
■ <b>Arcadia Towers</b> .....	16
■ <b>Terra Towers</b> .....	19
■ <b>JG Towers</b> .....	22
■ <b>Large Diameter Towers</b> .....	23
■ <b>Yukon Towers</b> .....	24
■ <b>Xenia Towers</b> .....	26
■ <b>Milano Towers</b> .....	27
■ <b>Gothic / Venus Towers</b> .....	28
■ <b>Ponte Towers</b> .....	29

# STAINLESS STEEL TOWERS

## GEFEST, SUN

- 304 Stainless Steel body
- 3/8" Copper Glycol recirculation lines
- Cold blocks to prevent foaming during first pour
- Triple-layer moisture and thermal insulation of glycol and product lines



### Gefest

Name	Part No.	Faucets
Gefest 1, Air	GFA152-1	1
Gefest 1, Glycol	GFG152-1	1
Gefest 2, Air	GFA152-2	2
Gefest 2, Glycol	GFG152-2	2

### SUN Tower

Name	Part No.	Faucets
SUN Tower 1, Glycol	SUN152-1	1
SUN Tower 2, Glycol	SUN152-2	2

### Available finishing



Tower Color Portfolio is on located on page 4 for many more colors. Special rates and lead time may apply

### Recommended Drip Trays

Tower	Drip Tray	Length	Width	Rinser/Drain Option
Gefest 1/2	DTU10x5SS	10"	5 1/2"	NO
Gefest 1/2	DTU12X7SS-ND	12"	7"	NO
Gefest 1/2	DTF16	16"	15 3/4"	YES
Sun Tower 1/2	DTU10x5SS	10"	5 1/2"	NO
Sun Tower 1/2	DTU12X7SS-ND	12"	7"	NO
Sun Tower 1/2	DTF16	16"	15 3/4"	YES



ILLUMINATED LOGO

SUN F



DTF16



DTF16



# STAINLESS STEEL TOWERS

## THE VICE

- 304 Stainless Steel body
- 3/8" Copper Glycol recirculation lines
- Cold blocks to prevent foaming during first pour
- Triple-layer moisture and thermal insulation of glycol and product lines



VICE **F**

Product lines are Vinyl, 3/16" I.D.  
Glycol lines are Copper, 3/8" O.D.

### Available finishing



Black Gold Copper

Tower Color Portfolio is on located on page 4 for many more colors. Special rates and lead time may apply



### Vice Tower

Name	Part No.	<b>F</b> aucets	<b>W</b> idth
Vice	VCE3	3	16 1/2"
Vice	VCE4	4	18 1/2"
Vice	VCE5	5	22 1/2"

### Recommended Drip Trays

Tower	Part No.	Length	Width	Rinser/Drain Option
VCE3 VCE4	DTU20X7SS-COSR	20"	7"	YES
VCE5	DTU28X10SS-COSR	28"	7"	YES

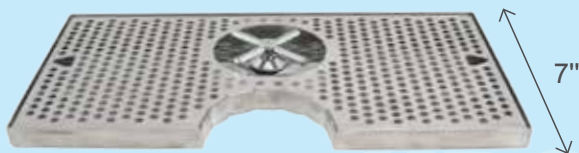

DTU20X7SS-COSR

# STAINLESS STEEL TOWERS

## INDIE

- 304 Stainless Steel body
- 3/8" Copper Glycol recirculation lines
- Cold blocks to prevent foaming during first pour
- Triple-layer moisture and thermal insulation of glycol and product lines



### Indie

Name	Part No.	Faucets
Indie 1, Air	IND1	1
Indie 1, Glycol	IND1G	1

### Available finishing



Black Gold Copper

Product lines are Vinyl, 3/16" I.D.  
Glycol lines are Copper, 3/8" O.D.

Tower Color Portfolio is on located on page 4 for many more colors.  
Special rates and lead time may apply



DTU10xSS



DTF16

### Recommended Drip Trays

Tower	Drip Tray	Length	Width	Rinser/Drain Option
Indie 1	DTU10xSS	10"	5 1/2"	NO
Indie 1	DTU12X7SS-ND	12"	7"	NO
Indie 1	DTF16	16"	15 3/4"	YES



INDIE F

18 1/2"

15"

3 3/16"

# STAINLESS STEEL TOWERS

## PERSEY

- 304 Stainless Steel body
- 3/8" Copper Glycol recirculation lines
- Cold blocks to prevent foaming during first pour
- Triple-layer moisture and thermal insulation of glycol and product lines



18 1/2"

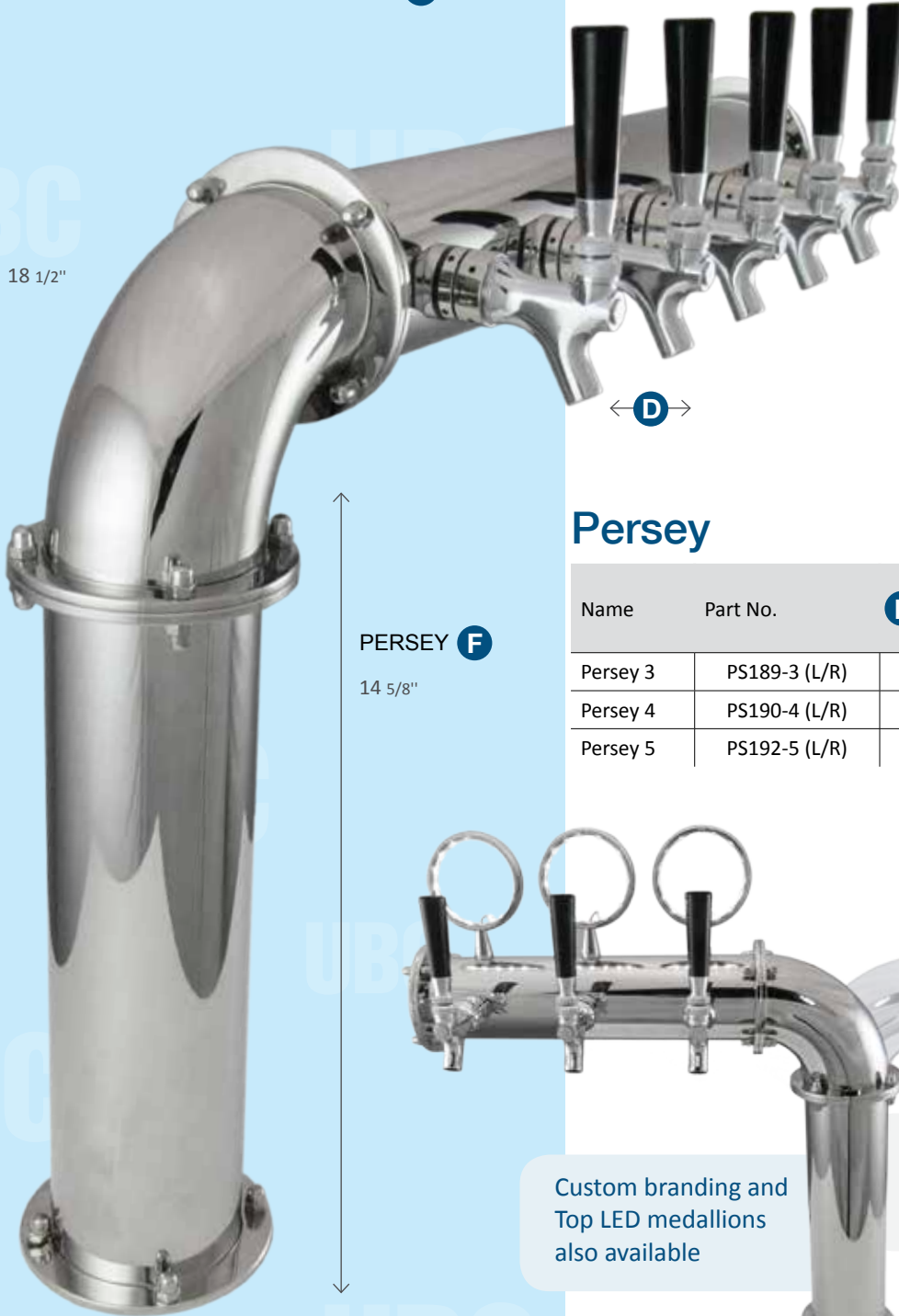

PERSEY **F**  
14 5/8"

3 3/16"

Left or Right arm configuration is determined by 'Bartender View'.

View the tower from the faucet side; the leg side determines the configuration (left / right)

### Persey

Name	Part No.	<b>F</b> aucets	<b>W</b> idth	<b>D</b> istance between faucets
Persey 3	PS189-3 (L/R)	3	19 5/8"	4 5/16"
Persey 4	PS190-4 (L/R)	4	24"	4 5/16"
Persey 5	PS192-5 (L/R)	5	28 5/16"	4 5/16"



Custom branding and Top LED medallions also available

Left or right arm configuration available

# STAINLESS STEEL TOWERS

## PERSEY SHORT LEG

- 304 Stainless Steel body
- 3/8" Copper Glycol recirculation lines
- Cold blocks to prevent foaming during first pour
- Triple-layer moisture and thermal insulation of glycol and product lines

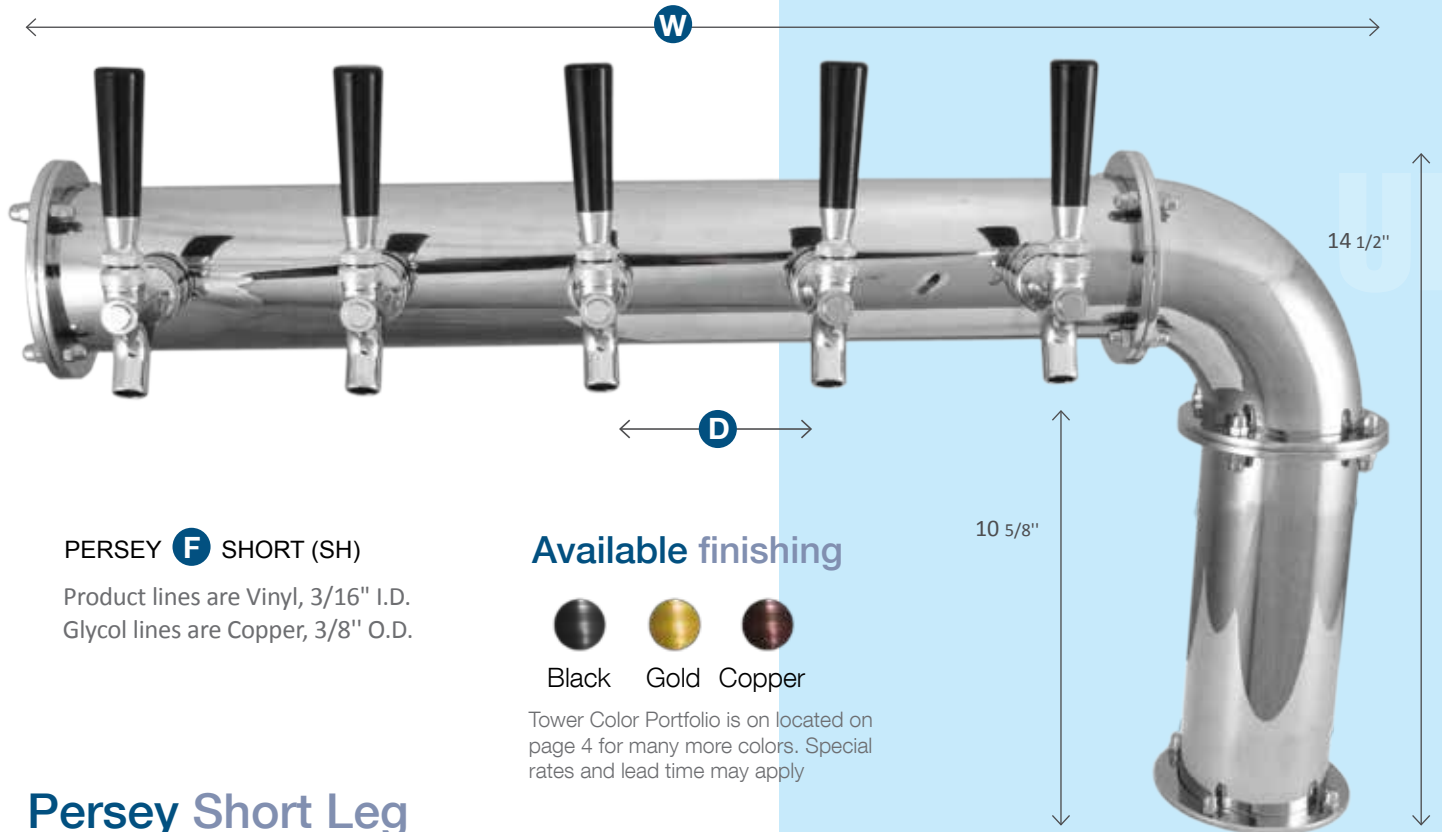

### PERSEY **F** SHORT (SH)

Product lines are Vinyl, 3/16" I.D.  
Glycol lines are Copper, 3/8" O.D.

### Available finishing



Black Gold Copper

Tower Color Portfolio is on located on page 4 for many more colors. Special rates and lead time may apply

## Persey Short Leg

Name	Part No.	<b>F</b> aucets	<b>W</b> idth	<b>D</b> istance between faucets
Persey 3 SH	PS189-3 (L/R)	3	19 5/8"	4 5/16"
Persey 4 SH	PS190-4 (L/R)	4	24"	4 5/16"
Persey 5 SH	PS192-5 (L/R)	5	28 5/16"	4 5/16"

## Recommended Drip Trays

Tower	Drip Tray	Length	Width	Rinser/Drain Option
Persey 3	DTUx15SS	15"	5 1/2"	NO
Persey 3	DTU12X7SS-ND	12"	7"	NO
Persey 3	DTU20X7SS	20"	7"	YES
Persey 4	DTU16X8SS	16"	7"	NO
Persey 4	DTU20X7SS	20"	7"	YES
Persey 5	DTU24X7SS	24"	7"	YES



# STAINLESS STEEL TOWERS

## ARCADIA

- 304 Stainless Steel body
- 3/8" Copper Glycol recirculation lines
- Cold blocks to prevent foaming during first pour
- Triple-layer moisture and thermal insulation of glycol and product lines



ARCADIA **F**



18 1/2"

14 5/8"

### Arcadia

Name	Part No.	<b>F</b> aucets	<b>W</b> idth	<b>D</b> istance between faucets
Arcadia 6	AC191-6	6	38 3/16"	4 5/16"
Arcadia 8	AC228-8	8	35 1/2"	3"
Arcadia 8 LED	AC228-8L	8	46 11/16"	4 5/16"
Arcadia 10	AC246-10	10	41 5/8"	3"
Arcadia 10 LED	AC246-10L	10	55 5/16"	4 5/16"
Arcadia 12	AC262-12	12	47 5/8"	3"
Arcadia 12 LED	AC262-12L	12	64 5/16"	4 5/16"
Arcadia 14	AC272-14	14	61"	3"

### Available finishing



Black Gold Copper

Product lines are Vinyl, 3/16" I.D.  
Glycol lines are Copper, 3/8" O.D.

Tower Color Portfolio is on located on page 4 for many more colors. Special rates and lead time may apply



\*Custom branding and Top LED medallions available



# STAINLESS STEEL TOWERS

## ARCADIA

- 304 Stainless Steel body
- 3/8" Copper Glycol recirculation lines
- Cold blocks to prevent foaming during first pour
- Triple-layer moisture and thermal insulation of glycol and product lines



### Arcadia Short Leg

Name	Part No.	<b>F</b> aucets	<b>W</b> idth	<b>D</b> istance between faucets
Arcadia 6 SH *	AC191-6W	6	38 3/16"	4 5/16"
Arcadia 8 SH	AC228-8	8	35 1/2"	3"
Arcadia 8W SH *	AC228-8W	8	46 11/16"	4 5/16"
Arcadia 10 SH	AC246-10	10	41 5/8"	3"
Arcadia 10W SH *	AC246-10W	10	55 5/16"	4 5/16"
Arcadia 12 SH	AC262-12	12	47 5/8"	3"
Arcadia 12W SH *	AC262-12W	12	64 5/16"	4 5/16"
Arcadia 14 SH *	AC272-14	14	61"	3"



ARCADIA **F** SHORT (SH)



STAINLESS STEEL TOWERS

# STAINLESS STEEL TOWERS

## ARCADIA NF

- 304 Stainless Steel body
- 3/8" Copper Glycol recirculation lines
- Cold blocks to prevent foaming during first pour
- Triple-layer moisture and thermal insulation of glycol and product lines



### Arcadia NF

Name	Part No.	<b>F</b> aucets	<b>W</b> idth	<b>D</b> istance between faucets
Arcadia 6 NF	AC191-6NF	6	37 1/2"	4 1/4"
Arcadia 8 NF	AC228-8NF	8	36 1/4"	3"
Arcadia 10 NF	AC246-10NF	10	42 1/2"	3"
Arcadia 12 NF	AC262-12NF	12	48 1/2"	3"

### Recommended Drip Trays

Tower	Drip Tray	Length	Width	Rinser/Drain Option
Arcadia 6	DTU24X7SS	24"	7"	YES
Arcadia 8	DTU24X7SS	24"	7"	YES
Arcadia 10	DTU36X7SS	36"	7"	YES
Arcadia 12	DTU36X7SS	36"	7"	YES
Arcadia 14	DTU54X7SS	54"	7"	YES



DTU36x7SSR



3 3/16"



ARCADIA **F** NF

# TERRA NF



- 304 Stainless Steel body
- 3/8" Copper Glycol recirculation lines
- Cold blocks to prevent foaming during first pour
- Triple-layer moisture and thermal insulation of glycol and product lines



TERRA **F** NF TOP LED

## Terra NF with top LED

Name	Part No.	<b>F</b> aucets	<b>W</b> idth	<b>D</b> istance between faucets
Terra 3 NF	TR224-3NF-TLED	3	15 7/8"	5 1/8"
Terra 4 NF	TR230-4NF-TLED	4	18 1/8"	4 3/8"
Terra 5 NF	TR211-5NF-TLED	5	26 7/8"	5 1/16"
Terra 6 NF	TR263-6NF-TLED	6	24 3/8"	3 7/8"



Product lines are Vinyl, 3/16" I.D.  
Glycol lines are Copper, 3/8" O.D.

## Terra NF

Name	Part No.	<b>F</b> aucets	<b>W</b> idth	<b>D</b> istance between faucets
Terra 3 NF	TR224-3NF	3	13 1/3"	4 1/2"
Terra 4 NF	TR230-4NF	4	18 1/8"	4 1/2"
Terra 5 NF	TR211-5NF	5	22 3/8"	5 1/2"
Terra 6 NF	TR263-6NF	6	24 1/4"	4"

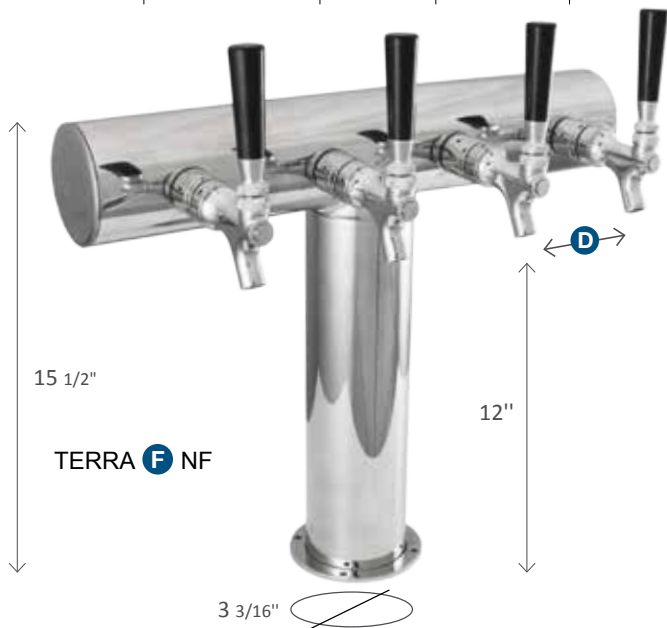

# STAINLESS STEEL TOWERS

## TERRA

- 304 Stainless Steel body
- 3/8" Copper Glycol recirculation lines
- Cold blocks to prevent foaming during first pour
- Triple-layer moisture and thermal insulation of glycol and product lines



### Available finishing



Tower Color Portfolio is on located on page 4 for many more colors. Special rates and lead time may apply

Product lines are Vinyl, 3/16" I.D.  
Glycol lines are Copper, 3/8" O.D.

Available with  
LED medallions

### Terra

Name	Part No.	Faucets	Width	Distance between faucets
Terra 2	TR188-2	2	9 7/8"	5 1/8"
Terra 3	TR224-3	3	15 7/8"	5 1/8"
Terra 4	TR230-4	4	17 1/4"	3 7/8"
Terra 5	TR211-5	5	26 7/8"	5 1/8"
Terra 6	TR263-6	6	25"	3 7/8"
Terra 8	TR270-8	8	32"	3 7/8"

### Terra Short Leg

Name	Part No.	Faucets	Width	Distance between faucets
Terra 2 SH	TR188-2	2	15 7/8"	5 1/8"
Terra 3 SH	TR224-3	3	15 7/8"	5 1/8"
Terra 4 SH	TR230-4	4	17 1/4"	3 7/8"
Terra 5 SH	TR211-5	5	26 7/8"	5 1/8"
Terra 6 SH	TR263-6	6	25"	3 7/8"
Terra 8 SH	TR270-8	8	32"	3 7/8"

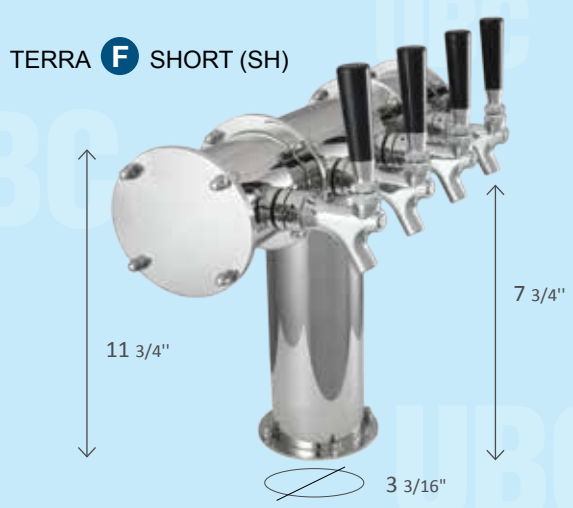

# STAINLESS STEEL TOWERS

## TERRA BRANDED

- 304 Stainless Steel body
- 3/8" Copper Glycol recirculation lines
- Cold blocks to prevent foaming during first pour
- Triple-layer moisture and thermal insulation of glycol and product lines



**NEW  
ARRIVAL**



## Terra Branded

Name	Part No.	Faucets	Width	Distance between faucets
Terra 2 BR	Terra 2 Branded	2		
Terra 3 BR	Terra 3 Branded	3	15 7/8"	5 1/8"
Terra 4 BR	Terra 4 Branded	4	18 1/8"	4 3/8"
Terra 5 BR	Terra 5 Branded	5	26 7/8"	5 1/16"
Terra 6 BR	Terra 6 Branded	6	24 3/8"	3 7/8"

## Available finishing



Black Gold Copper

Tower Color Portfolio is on located on page 4 for many more colors. Special rates and lead time may apply

Product lines are Vinyl, 3/16" I.D.  
Glycol lines are Copper, 3/8" O.D.



DTU12X7SS



DTU36X7SSR

## Recommended Drip Trays

Tower	Drip Tray	Length	Width	Rinser/Drain
Terra 2/3	DTU12X7SS-ND	12"	7"	NO
Terra 4	DTU16X8SS	16"	8"	NO
	DTU20X7SS	20"	7"	YES
Terra 5/6	DTU24X7SS	24"	7"	YES
Terra 8	DTU36X7SS	36"	7"	YES



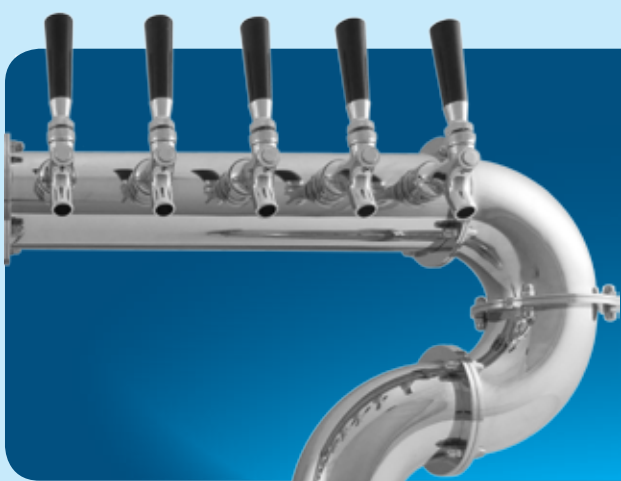

# STAINLESS STEEL TOWERS

## JG

- 304 Stainless Steel body
- 3/8" Copper Glycol recirculation lines
- Cold blocks to prevent foaming during first pour
- Triple-layer moisture and thermal insulation of glycol and product lines

### JG Tower

Name	Part No.	Faucets	Width	Distance between faucets
JG Tower 3	JG190-3	3	19 5/8"	4 5/16"
JG Tower 4	JG190-4	4	24"	4 5/16"
JG Tower 6	JG190-7	6	38 3/16"	4 5/16"
JG Tower 8	JG190-8	8	35 1/2"	3"
JG Tower 10	JG190-10	10	41 5/8"	3"
JG Tower 12	JG190-12	12	47 5/8"	3"

### Recommended Drip Trays

Tower	Drip Tray	Length	Width	Rinser/Drain Option
JG Tower 3	DTU12X7SS	12"	7"	NO
JG Tower 4	DTU16X8SS	16"	7"	NO
JG Tower 6	DTU24X7SS	24"	7"	YES
JG Tower 8	DTU24X7SS	24"	7"	YES
JG Tower 10	DTU36X7SS	36"	7"	YES
JG Tower 12	DTU45X7SS	45"	7"	YES

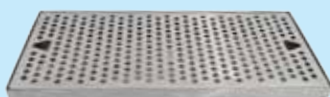
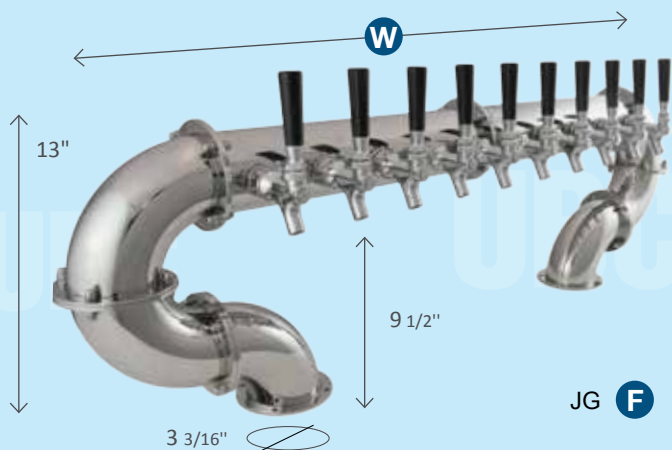

DTU12X7SS

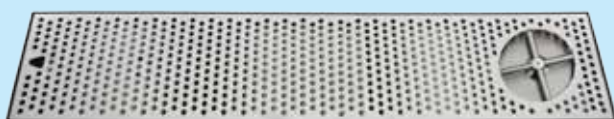

DTU36X7SS-SR



Available finishing



Tower Color Portfolio is located on page 4 for many more colors. Special rates and lead time may apply

Product lines are Vinyl, 3/16" I.D.  
Glycol lines are Copper, 3/8" O.D.

# STAINLESS STEEL TOWERS

## LARGE DIAMETER



- Larger 4" diameter for more significant look
- 304 Stainless Steel body
- 3/8" Copper Glycol recirculation lines
- Triple-layer moisture and thermal insulation of glycol and product lines



### Ex 4" Bridge

Name	Part No.	Faucets	Width
Bridge 8	EXB-8	8	43 3/5"
Bridge 10	EXB-10	10	49 1/2"
Bridge 12	EXB-12	12	55 3/7"
Bridge 14	EXB-14	14	61 3/8"

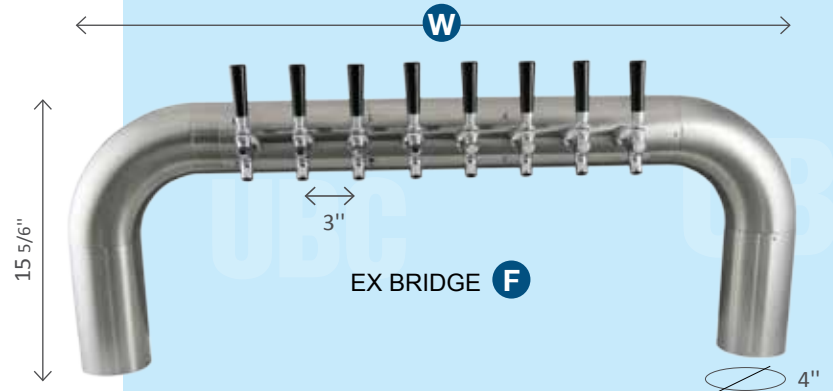

### Ex 4" Arch

Name	Part No.	Faucets	Width
Arch 8	EXA-8	8	39 1/2"
Arch 10	EXA-10	10	45 7/16"
Arch 12	EXA-12	12	51 3/8"
Arch 14	EXA-14	14	57 1/4"

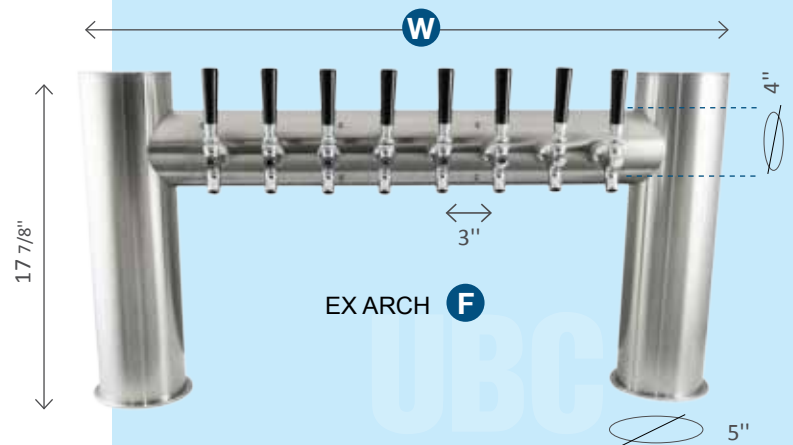

### FM 4" Pass Thru

Name	Part No.	Faucets	Width
Pass Thru 6	EXM-6	6	31 1/2"
Pass Thru 8	EXM-8	8	39"
Pass Thru 10	EXM-10	10	46 1/4"
Pass Thru 12	EXM-12	12	54"
Pass Thru 14	EXM-14	14	61 1/2"
Pass Thru 16	EXM-16	16	69"

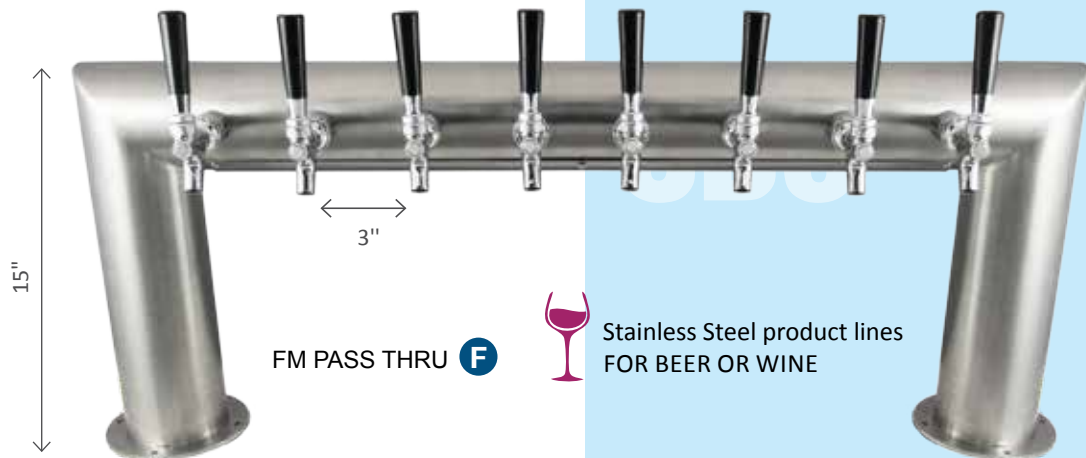

Product lines are Vinyl, 3/16" I.D.  
Glycol lines are Copper, 3/8" O.D.



Stainless Steel product lines  
FOR BEER OR WINE

# STAINLESS STEEL TOWERS

## YUKON

- 304 Stainless Steel body
- 3/8" Copper Glycol recirculation lines
- Cold blocks to prevent foaming during first pour
- Triple-layer moisture and thermal insulation of glycol and product lines

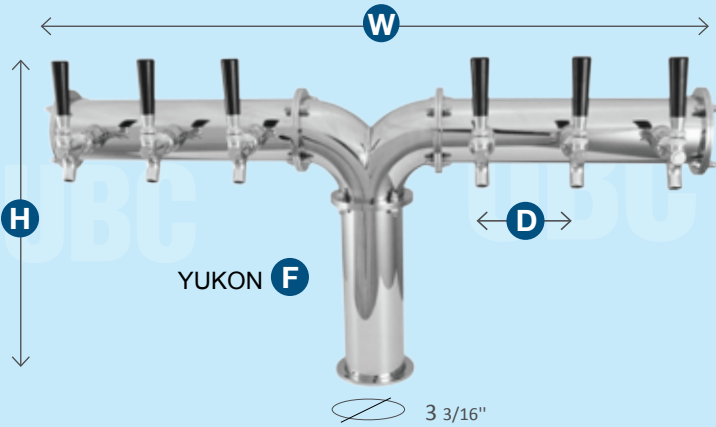

## Yukon

Name	Part No.	Faucets	Width	Distance between faucets
Yukon 4	YK278-4T	4	25 7/8"	4 5/16"
Yukon 5	YK278-5T	5	30 1/4"	4 5/16"
Yukon 6	YK278-6T	6	34 9/16"	4 5/16"
Yukon 8	YK278-8T	8	51 3/4"	4 5/16"
Yukon 10	YK278-10T	10	60 1/2"	4 5/16"
Yukon 12	YK278-12T	12	67 13/16"	4 5/16"

**NOTE:** Yukon 8, 10, and 12 has 2 legs

Product lines are Vinyl, 3/16" I.D.  
Glycol lines are Copper, 3/8" O.D.

### Available finishing



Tower Color Portfolio is on located on page 4 for many more colors. Special rates and lead time may apply



# STAINLESS STEEL TOWERS YUKON TOP LED



- 304 Stainless Steel body
- 3/8" Copper Glycol recirculation lines
- Cold blocks to prevent foaming during first pour
- Triple-layer moisture and thermal insulation of glycol and product lines

## Yukon Top LED

Name	Part No.	Faucets	Width	Distance between faucets
Yukon 4	YK278-4T	4	25 7/8"	4 5/16"
Yukon 5	YK278-5T	5	30 1/4"	4 5/16"
Yukon 6	YK278-6T	6	34 9/16"	4 5/16"
Yukon 8	YK278-8T	8	51 3/4"	4 5/16"
Yukon 10	YK278-10T	10	60 1/2"	4 5/16"
Yukon 12	YK278-12T	12	67 13/16"	4 5/16"

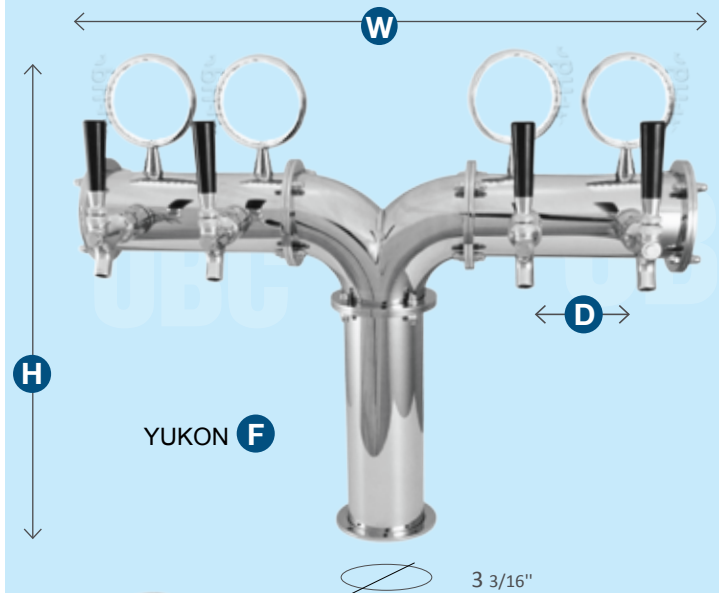

## Recommended Drip Trays

Tower	Drip Tray	Length	Width	Rinser/ Drain
Yukon 4	DTU24X7SS	24"	7"	YES
Yukon 5	DTU24X7SS	24"	7"	YES
Yukon 6	DTU36X7SS	36"	7"	YES
Yukon 8	DTU36X7SS+DTU20X7SS	56"	7"	YES
Yukon 10	DTU36X7SS +DTU24X7SS	60"	7"	YES
Yukon 12	DTU45X7SS + DTU24X7SS	68"	7"	YES

### Available finishing

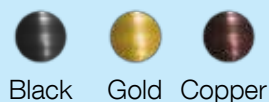

Tower Color Portfolio is on located on page 4 for many more colors. Special rates and lead time may apply

# EUROPEAN STYLE TOWERS

## XENIA TOWER

- Designed for Still Water and Carbonated Water
- Stylish design
- Easy to operate
- Made in Europe



### Xenia Tower

Name	Part No.	Lines
Xenia with Levers	XNA3CL	3
Xenia with Buttons	XNA3CB	3

Option of Buttons or Levers



Adjustable Faucet

**Three Settings:**  
 Filtered  
 Filtered and Chilled  
 Carbonated



### Recommended Drip Trays

Tower	Drip Tray	Length	Width	Rinser/Drain Option
Xenia	DTU10x5SS	10"	5 1/2"	NO
Xenia	DTF16	16"	15 3/4"	YES

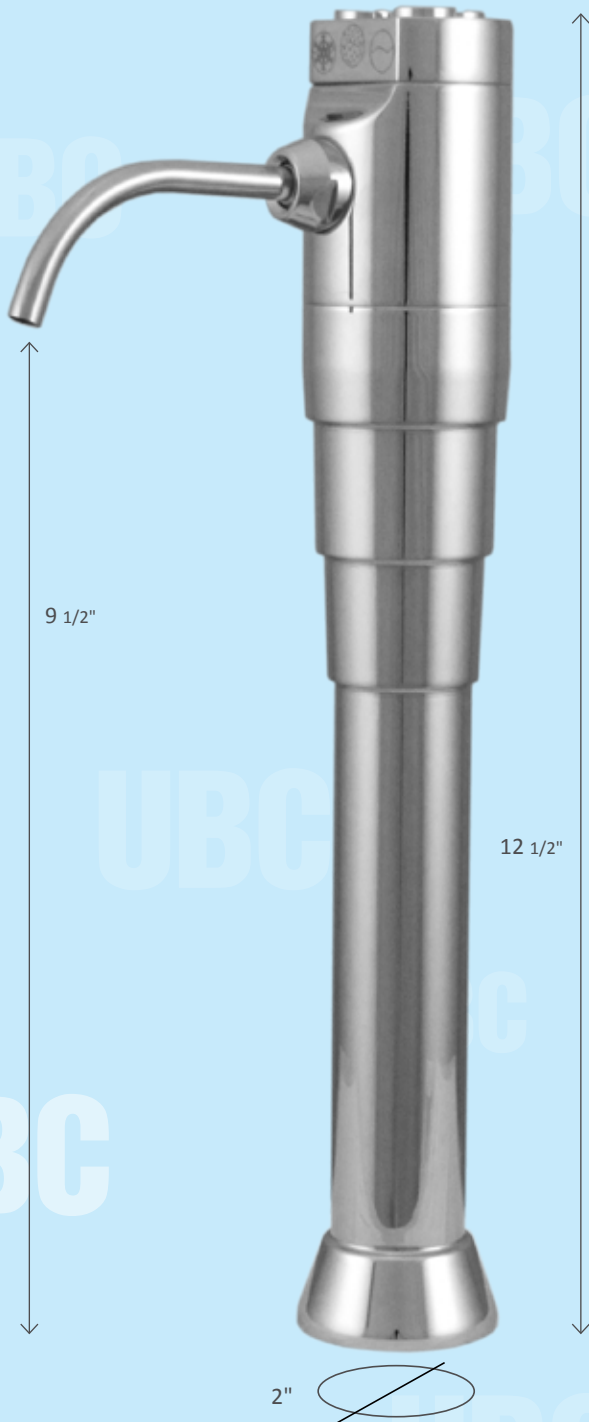

# EUROPEAN STYLE TOWERS

## MILANO

- 304 Stainless Steel product lines and shanks
- Recommended for wine and beer dispensing
- 3/8" Copper Glycol recirculation lines
- Optional LED medallions

### Milano

Name	Part No.	<b>F</b> aucets	<b>W</b> idth
Milano 1, Chrome	MLN1C	1	4" (base width)
Milano 2, Chrome	MLN2C	2	5" (faucet to faucet)
Milano 3, Chrome	MLN3C	3	8" (faucet to faucet)
Milano 4, Chrome	MLN4C	4	10" (faucet to faucet)
Milano 1, Gold	MLN1G	1	4" (base width)
Milano 2, Gold	MLN2G	2	5" (faucet to faucet)
Milano 3, Gold	MLN3G	3	8" (faucet to faucet)
Milano 4, Gold	MLN4G	4	10" (faucet to faucet)



 Stainless Steel product lines  
FOR BEER OR WINE

Product lines are Vinyl, 3/16" I.D.  
Glycol lines are Copper, 3/8" O.D.

### Recommended Drip Trays

Tower	Drip Tray	Length	Width	Rinser
Milano 1 Milano 2	DTU10x5SS	10"	5 1/2"	NO
	DTU12X7SS-ND	12"	7"	NO
Milano 3	DTF16	16"	15 3/4"	YES
	DTU12X7SS	12"	7"	NO
Milano 4	DTF16	16"	15 3/4"	YES
	DTU16X8SS	16"	7"	NO

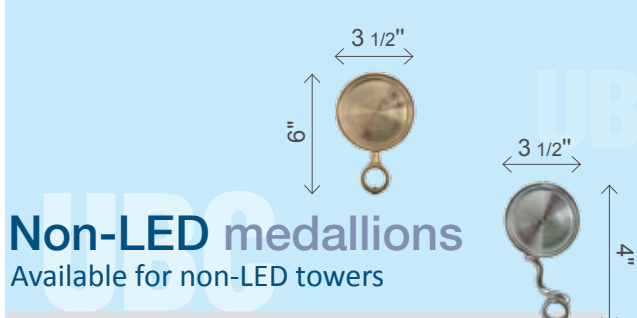

	Part No.
Medallion, Chrome	MBRSC
Medallion, Gold	MBRSG
Medallion type S, Chrome	MBRSSC
Medallion type S, Gold	MBGSSG
Medallion type S, Gold	MBRSSG

STAINLESS STEEL TOWERS



# EUROPEAN STYLE TOWERS GOTHIC, VENUS

- The only Cobra™-style tower with cold blocks to prevent foaming during first pour
- 304 Stainless Steel product lines and shanks
- Recommended for wine and beer dispensing
- 3/8" Copper Glycol recirculation lines



GOTHIC **F**

Stainless Steel product lines  
FOR BEER OR WINE

Available with  
LED medallions

NOTE: Base is pentagon shaped



VENUS **F**

Venus 1  
Chrome, LED

\*Custom branding available

Product lines are Vinyl, 3/16" I.D.  
Glycol lines are Copper, 3/8" O.D.

## Recommended Drip Trays

Tower	Drip Tray	Length	Width	Rinser
Gothic 2	DTU10x5SS	10"	5 1/2"	NO
	DTU12X7SS-ND	12"	7"	NO
	DTF16	16"	15 3/4"	YES
Gothic 3	DTU12X7SS-ND	12"	7"	NO
	DTF16	16"	15 3/4"	YES
Gothic 4	DTU16X8SS	16"	7"	NO
	DTF16	16"	15 3/4"	YES

## Gothic

Name	Part No.	<b>F</b> aucets	<b>H</b> eight	<b>W</b> idth
Gothic 2, Chrome	GTH2C	2	16 9/16"	4"
Gothic 2, LED	GTH2LED	2	20 1/2"	7 1/2"
Gothic 3, Chrome	GTH3C	3	17 5/16"	10"
Gothic 3, LED	GTH3LED	3	22"	11"
Gothic 4, Chrome	GTH4C	4	17 5/16"	10"
Gothic 4, LED	GTH4LED	4	23"	14"

## Venus

Name	Part No.	<b>F</b> aucets	<b>W</b> idth
Venus 1, Chrome, LED*	VN1CLED	1	3" (top)

# EUROPEAN STYLE TOWERS

## PONTE 4"

- Larger 4" diameter for a more significant look
- 304 Stainless Steel body
- 3/8" Copper Glycol recirculation lines
- Chrome or brushed copper finishing available



### Ponte

Name	Part No.	Faucets	Width	Distance between faucets
Ponte 6, Chrome	PONTE6C	6	51"	4 7/8"
Ponte 8, Chrome	PONTE8C	8	62 3/8"	4 7/8"
Ponte 6, Copper Brush	PONTE6GB	6	51"	4 7/8"
Ponte 8, Copper Brush	PONTE8GB	8	62 3/8"	4 7/8"

### Available finishing



Black Gold Copper

Tower Color Portfolio is on located on page 4 for many more colors. Special rates and lead time may apply



Ponte Tower is significantly thicker than the average tower

### Recommended Drip Trays

Tower	Drip Tray	Length	Width	Rinser
Ponte 6, Chrome/ Copper Brush	DTU45X7SS-CR	45"	7"	YES
Ponte 8, Chrome/ Copper Brush	DTU48x7SS-CR	48"	7"	YES
	DTU54X7SS-CR	54"	7"	YES

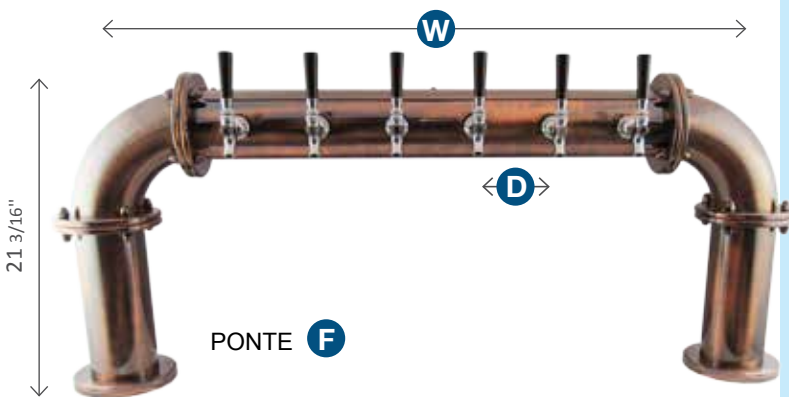

PONTE **F**

Product lines are Stainless Steel, 3/16" I.D.  
Glycol lines are Copper, 3/8" O.D.

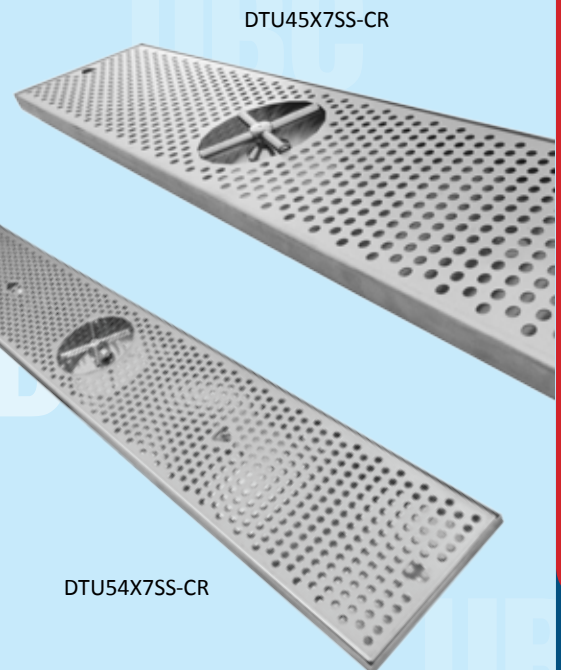

# AMERICAN STYLE TOWERS



## American Style Towers

- Heavy duty design
- Glycol Cooled and Air Cooled
- 3" and 4" pedestal diameter

■ <b>Cylinder Towers</b> .....	31
■ <b>Tee Box Towers</b> .....	32
■ <b>Double Pedestal Towers</b> .....	33
■ <b>Wall Mount &amp; Under Bar Dispensers</b> ....	34

# AMERICAN STYLE TOWERS CYLINDER

- Ideal for special events
- 304 Stainless Steel body
- Optional Glycol or Air cooling
- 3/8" Copper Glycol recirculation lines



## Cylinder

Name	Part No.	F faucets	H height
3" Cylinder 1, Chrome, AIR	D4743T	1	12"
3" Cylinder 1, Chrome, GLYCOL	D4743TG	1	12"
3" Cylinder 1, Chrome, GLYCOL LED	D4743TG-LED	2	16 1/4"
3" Cylinder 2, Chrome, AIR	D4743DT	2	12"
3" Cylinder 2, Chrome, GLYCOL	D4743DTG	2	12"
3" Cylinder 3, Chrome, AIR	D4743TT	3	12"
3" Cylinder 3, Chrome, GLYCOL	D4743TTG	3	12"

## Tower Extensions

Part No.	Description
ADD-1	3" Chrome Tower Extension from 1 to 2
ADD-2	3" Chrome Tower Extension from 1 to 3
ADD-3	3" Chrome Tower Extension from 2 to 3



ADD-2

## Available finishing



Black Gold Copper

Tower Color Portfolio is on located on page 4 for many more colors. Special rates and lead time may apply



DTB9

Available with  
Branding on Page 101



Available with  
LED medallions



## Recommended Drip Trays

Part No.	Length	Width	Height	Rinser
DTU10x5SS	10"	5 1/2"	3/4"	NO
DTU12x7SS	12"	7"	3/4"	NO
DTB9	6 1/2"	6 1/2"	5"	NO



# AMERICAN STYLE TOWERS TEE BOX

- Well established and recognized design
- Optional Glycol or Air cooling
- Satin finish Stainless Steel body
- 3/16" Vinyl product lines

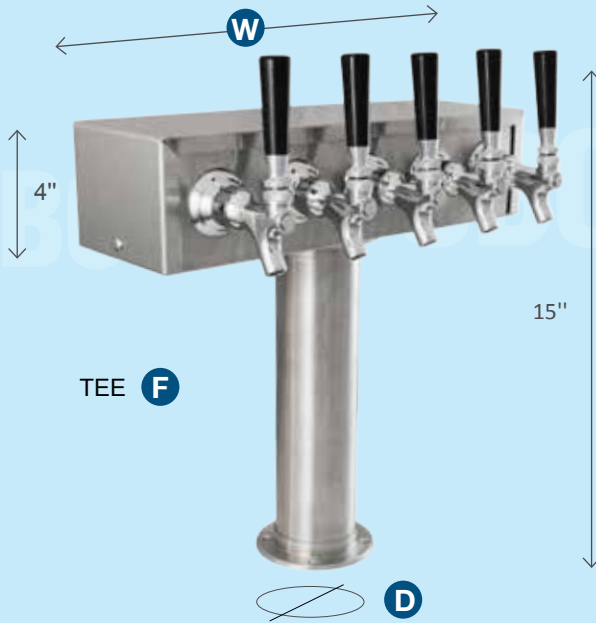

TEE **F**

Product lines are Vinyl, 3/16" I.D.  
Glycol lines are Copper, 3/8" O.D.



## Tee Box

Name	Part No.	<b>F</b> aucets	<b>W</b> idth
<b>D</b> 3" Pedestal Tubes			
Tee Box 2, Chrome, AIR	TT2CR	2	10"
Tee Box 2, Chrome, GLYCOL	TT2CRG	2	10"
Tee Box 3, Chrome, AIR	TT3CR	3	10"
Tee Box 3, Chrome, GLYCOL	TT3CRG	3	10"
Tee Box 4, Chrome, AIR	TT4CR	4	13"
Tee Box 4, Chrome, GLYCOL	TT4CRG	4	13"
Tee Box 5, Chrome, AIR	TT5CR	5	16"
Tee Box 5, Chrome, GLYCOL	TT5CRG	5	16"
Tee Box 6, Chrome, AIR	TT6CR	6	19"
Tee Box 6, Chrome, GLYCOL	TT6CRG	6	19"
Tee Box 8, Chrome, AIR	TT8CR	8	25"
Tee Box 8, Chrome, GLYCOL	TT8CRG	8	25"

<b>D</b> 4" Pedestal Tubes			
Tee Box 6, Chrome, AIR	TTB6SS	6	19"
Tee Box 6, Chrome, GLYCOL	TTB6SSG	6	19"
Tee Box 8, Chrome, AIR	TTB8SS	8	25"
Tee Box 8, Chrome, GLYCOL	TTB8SSG	8	25"

### Available finishing



Tower Color Portfolio is on located on page 4 for many more colors. Special rates and lead time may apply

### Recommended Drip Trays

Part No.	Length	Width	Height	Rinser
DTU24x5SS	24"	5 1/2"	3/4"	NO
DTU30x5SS	30"	5 1/2"	3/4"	NO
DTU36x5SS	36"	5 1/2"	3/4"	NO
DTU48x7SS	48"	7"	3/4"	NO

TOLL FREE: 1 (866) 995-9965, www.beer-co.ca



# AMERICAN STYLE TOWERS

## DOUBLE PEDESTAL

- Well established and recognized design
- Optional Glycol or Air cooling
- Satin finish Stainless Steel body
- 3/16" Vinyl product lines



### Double Pedestal

Name	Part No.	Faucets	Width
<b>D</b> 3" Pedestal Tubes			
Pass Thru Box 6, Chrome, AIR	PT6SS	6	19"
Pass Thru Box 6, Chrome, GLYCOL	PT6SSG	6	19"
Pass Thru Box 8, Chrome, AIR	PT8SS	8	25"
Pass Thru Box 8, Chrome, GLYCOL	PT8SSG	8	25"
Pass Thru Box 10, Chrome, AIR	PT10SS	10	31"
Pass Thru Box 10, Chrome, GLYCOL	PT10SSG	10	31"
Pass Thru Box 12, Chrome, AIR	PT12SS	12	37"
Pass Thru Box 12, Chrome, GLYCOL	PT12SSG	12	37"
<b>D</b> 4" Pedestal Tubes			
Pass Thru Box 8, Chrome, AIR	PTB8SS	8	25"
Pass Thru Box 8, Chrome, GLYCOL	PTB8SSG	8	25"
Pass Thru Box 10, Chrome, AIR	PTB10SS	10	31"
Pass Thru Box 10, Chrome, GLYCOL	PTB10SSG	10	31"
Pass Thru Box 12, Chrome, AIR	PTB12SS	12	37"
Pass Thru Box 12, Chrome, GLYCOL	PTB12SSG	12	37"

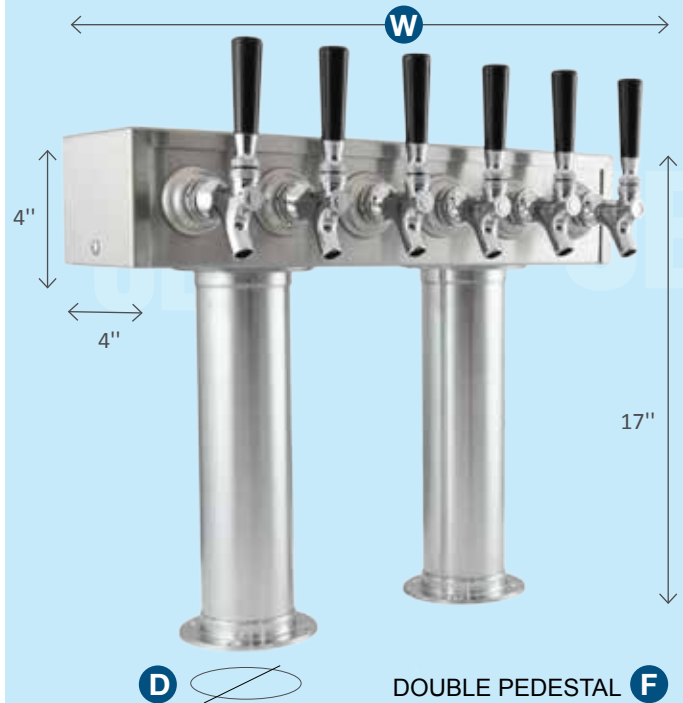

Product lines are Vinyl, 3/16" I.D.  
Glycol lines are Copper, 3/8" O.D.

### Available finishing



Tower Color Portfolio is located on page 4 for many more colors. Special rates and lead time may apply

### Recommended Drip Trays

Part No.	Length	Width	Rinser
DTU24x5SS	24"	5 1/2"	N
DTU20x7SS-CR	20"	7"	Y
DTU30x5SS	30"	5 1/2"	N
DTU30x7SS-CR	30"	7"	Y
DTU36x7SS-CR	36"	7"	Y



# WALL MOUNT & UNDER BAR DISPENSERS



- Well established and recognized design
- Optional Glycol or Air cooling
- Satin finish Stainless Steel body
- 3/8" Copper Glycol lines
- 3/16" Vinyl product lines

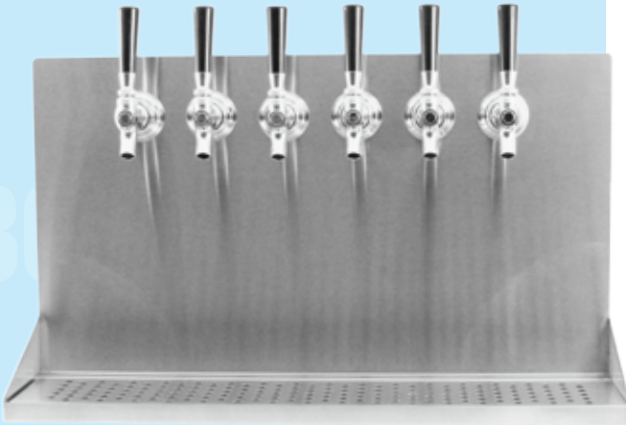

WALL MOUNT **F**



UNDER BAR **F**

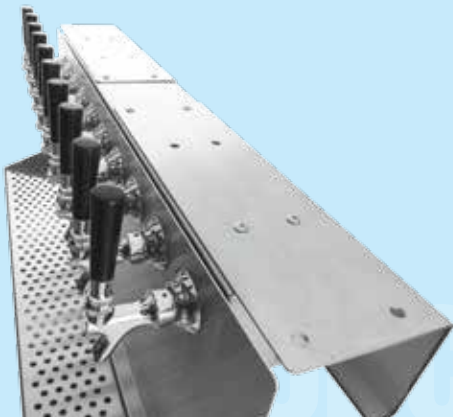

## Wall Mount Dispensers

Name	Part No.	<b>F</b> aucets	<b>W</b> idth
Wall Mount 2, AIR	WMD15-2	2	15"
Wall Mount 2, GLYCOL	WMD15-2G	2	15"
Wall Mount 3, AIR	WMD15-3	3	15"
Wall Mount 3, GLYCOL	WMD15-3G	3	15"
Wall Mount 4, AIR	WMD15-4	4	15"
Wall Mount 4, GLYCOL	WMD15-4G	4	15"
Wall Mount 5, AIR	WMD24-5	5	24"
Wall Mount 5, GLYCOL	WMD24-5G	5	24"
Wall Mount 6, AIR	WMD24-6	6	24"
Wall Mount 6, GLYCOL	WMD24-6G	6	24"
Wall Mount 8, AIR	WMD30-8	8	30"
Wall Mount 8, GLYCOL	WMD30-8G	8	30"
Wall Mount 10, AIR	WMD36-10	10	36"
Wall Mount 10, GLYCOL	WMD36-10G	10	36"

## Under Bar Dispensers

Name	Part No.	<b>F</b> aucets	<b>W</b> idth
Under Bar 2, AIR	UBD15-2	2	15"
Under Bar 2, GLYCOL	UBD15-2G	2	15"
Under Bar 3, AIR	UBD15-3	3	15"
Under Bar 3, GLYCOL	UBD15-3G	3	15"
Under Bar 4, AIR	UBD15-4	4	15"
Under Bar 4, GLYCOL	UBD15-4G	4	15"
Under Bar 5, AIR	UBD24-5	5	24"
Under Bar 5, GLYCOL	UBD24-5G	5	24"
Under Bar 6, AIR	UBD24-6	6	24"
Under Bar 6, GLYCOL	UBD24-6G	6	24"
Under Bar 8, AIR	UBD30-8	8	30"
Under Bar 8, GLYCOL	UBD30-8G	8	30"
Under Bar 10, AIR	UBD36-10	10	36"
Under Bar 10, Glycol	UBD36-10	10	36"
Under Bar 12, GLYCOL	UBD36-10G	12	36"

TOLL FREE: 1 (866) 995-9965, [www.beer-co.ca](http://www.beer-co.ca)



## Ice Towers

- Exclusive appeal
- ICE towers will develop a layer of ice perfect for mouth watering beer appeal
- The smooth frosted exterior makes an elegant statement on any bar top setting

■ <b>TOF / Arcadia ICE Towers</b> .....	36
■ <b>Cobra ICE Towers</b> .....	37

# ICE TOWERS

## TOF, ARCADIA

- Designed to attract attention
- 304 Stainless Steel body
- 3/8" Copper Glycol recirculation lines
- Available with LED medallions



### TOF ICE Towers

Name	Part No.	Faucets	<b>H</b> eight	<b>W</b> idth
TOF 2, ICE, Chrome, LED	TOF2CICELED	2	15 1/2"	5 1/2"
TOF 3, ICE, Chrome, LED	TOF3CICELED	3	15 1/2"	5 1/2"

### Arcadia ICE Towers

Name	Part No.	Faucets	<b>H</b> eight	<b>W</b> idth
Arcadia 4, ICE	AC-ICE4	4	16"	26 3/16"
Arcadia 8, ICE	AC-ICE8	8	16"	35 1/2"

### Recommended Drip Trays

Tower	Part No.	Width	Length	Rinser
TOF 2, Chrome, ICE	DTF16	15 3/4"	15 3/4"	NO
TOF 3, Chrome, ICE	DTF16R	15 3/4"	15 3/4"	YES
Arcadia 4, ICE	DTF32	15 3/4"	31 1/2"	YES
	DTF32R	15 3/4"	31 1/2"	YES



# ICE TOWERS

## COBRA™ ICE



- Designed to attract attention
- 304 Stainless Steel product lines and shanks
- 3/8" Copper Glycol recirculation lines

### Cobra ICE

Name	Part No.	<b>F</b> aucets	<b>H</b> eight	<b>W</b> idth
Cobra™ 1, Chrome, ICE	CBR1CICE	1	14 15/16"	4 5/16"
Cobra™ 1, Chrome, ICE, LED	CBR1CICELED	1	18 1/8"	4 5/16"
Cobra™ 2, Chrome, ICE	CBR2CICE	2	15 3/16"	4 5/16"
Cobra™ 2, Chrome, ICE, LED	CBR2CICELED	2	16 7/8"	7 9/16"

### Recommended Drip Trays

Tower	Part No.	Length	Width	Rinser
Cobra™ 1, Chrome, ICE	DTF16	15 3/4"	15 3/4"	NO
Cobra™ 1, Chrome, ICE, LED				
Cobra™ 2, Chrome, ICE	DTF16R	15 3/4"	15 3/4"	YES
Cobra™ 2, Chrome, ICE, LED				



DTF16



DTF16R

Product lines are Stainless Steel, 3/16" I.D.  
Glycol lines are Copper, 3/8" O.D.



COBRA™ **F** ICE



COBRA™ 2, ICE



# CERAMIC TOWERS



## Ceramic Towers

- Add a unique traditional European look to any bar with beautiful ceramic towers
- Available in a variety of colors with your choice of Chrome or Brass hardware
- Permanent customized logos can be added to ceramic towers (set-up fees may apply)

# SILVA

- Great retro style design
- Custom branding and other body colors available (special prices and lead times may apply)
- Towers are available in chrome or gold finish
- Optional Glycol or Air cooling



## Silva 1-3

Name	Part No.	Cooling	Faucets	Width
Silva 1	CTSL1	Air	1	7"
Silva 2	CTSL2	Air	2	7"
Silva 3	CTSL3	Air	3	12"
Silva 1	CTSL1G	Glycol	1	7"
Silva 2	CTSL2G	Glycol	2	7"
Silva 3	CTSL3G	Glycol	3	12"

## Silva 4-8

Name	Part No.	Cooling	Faucets	Width
Silva 4	CTSL4	Air	4	12 1/4"
Silva 6	CTSL6	Air	6	17 3/4"
Silva 8	CTSL8	Air	6	23 5/16"
Silva 4	CTSL4G	Glycol	4	12 1/4"
Silva 6	CTSL6G	Glycol	6	17 3/4"
Silva 8	CTSL8G	Glycol	6	23 5/16"

Towers are stocked in



Red



White



Black

100+ colors and patterns available upon special request



Custom Branding Available

Available in chrome or gold



Product lines are Vinyl, 3/16" I.D.  
Glycol lines are Copper, 3/8" O.D.

SILVA F 1-3



SILVA F 4-8



# FAUCETS AND SHANKS

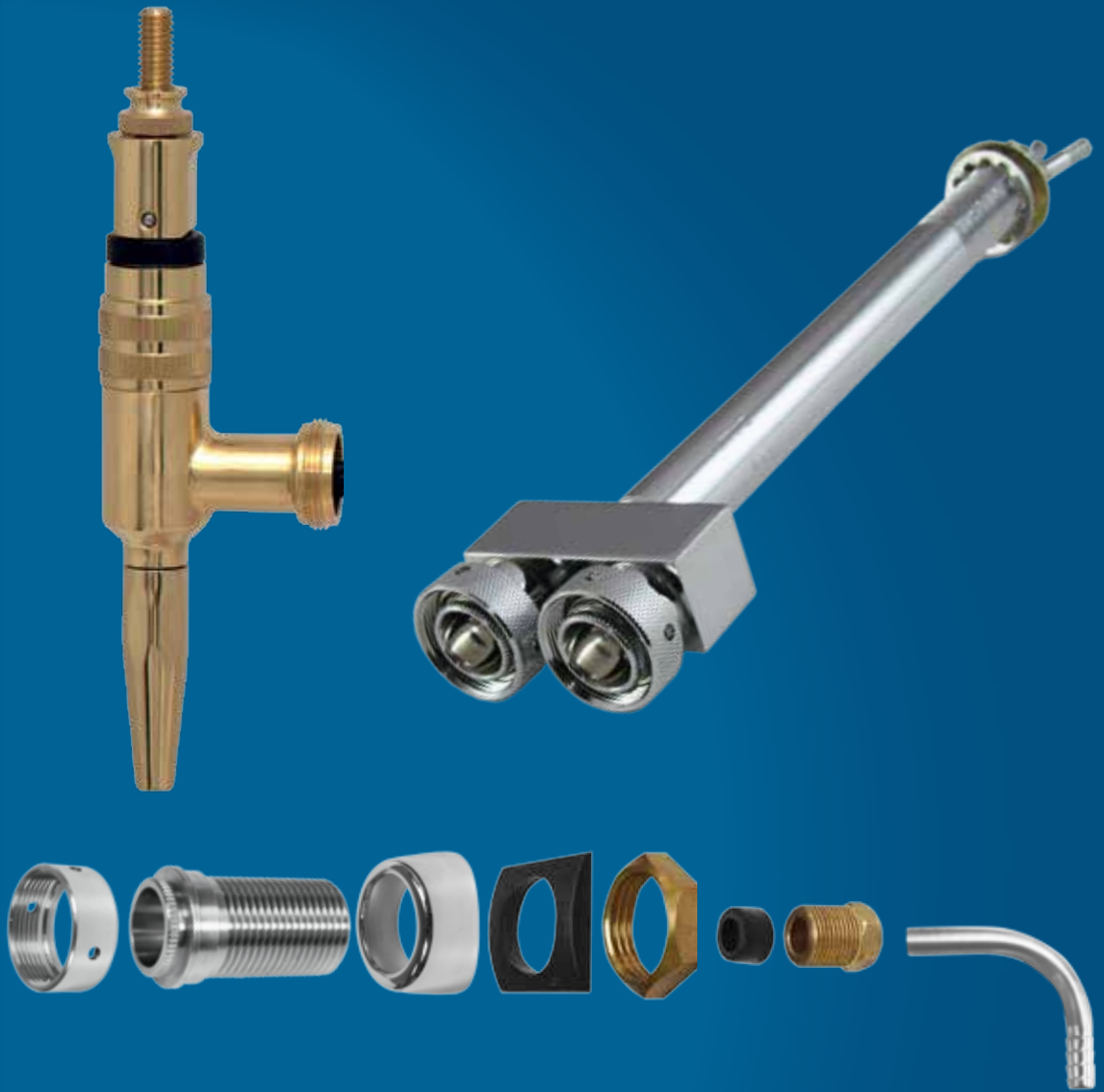

## Faucets and Shanks

- Complete line of domestic and European shanks and faucets
- Full set of replacement faucet parts and accessories
- Innovative design - Domestic, European and Fast-Pour faucets
- 304 Stainless Steel or Brass faucets and shanks
- Industry standard quality of assembly and finishing

■ <b>Shanks &amp; Parts</b> .....	40
■ <b>Faucets</b> .....	43
■ <b>Faucet Accessories</b> .....	44



# FAUCETS AND SHANKS

## SHANKS & PARTS

- 304 Stainless Steel or Brass shanks
- Available in a variety of sizes
- Chrome or Brass spacers



### Shank Assembly Dual Shanks

Part No.	Description
SH8CA2	8" with 3/16" tubing for 2 lines
SH10CA2	10" with 3/16" tubing for 2 lines

### Shank Assembly Without Nipple

Part No.	Description
SH2C	1 3/4" with 3/16" bore, SS, chrome coupling nut
SH2B	1 3/4" with 3/16" bore, SS, brass coupling nut
SH3CA	3 1/8" with 3/16" bore
SH4CA	4 1/8" with 3/16" bore
SH5CA	5 1/8" with 3/16" bore
SH6CA	6 1/8" with 3/16" bore
SH8CA	8 1/8" with 3/16" bore
SH10CA	10 1/8" with 3/16" bore
SH12CA	12 1/8" with 3/16" bore
SH3CA14SS	Stainless Steel, 3 1/8" with 1/4" bore
SH132	Cooler coupling, 3" assembly, 5/16" bore
SH133	Cooler coupling 4" assembly, 5/16" bore

### Shank Assembly With Nipple

Part No.	Description
SH2	2 1/2" with 3/16" bore, 3/16" nipple
SH2BA	1 3/4" with 3/16" bore & elbow, brass coupling nut & spacer
SH2CA	1 3/4" with 3/16" bore & elbow, chrome coupling nut & spacer
SH2BAN	1 3/4" with 3/16" bore & nipple, brass coupling nut & spacer
SH2CAN	1 3/4" with 3/16" bore & nipple, chrome coupling nut, spacer
SH2BANS	2 1/4" with 3/16" bore & spinning elbow, brass coupling nut & spacer
SH2CANS	2 1/4" with 3/16" bore & spinning elbow, chrome coupling nut & spacer
SH3CAN	3" with 3/16" bore, 3/16" nipple
SH4CAN	4" with 3/16" bore, 3/16" nipple
SH5CAN	5" with 3/16" bore, 3/16" nipple

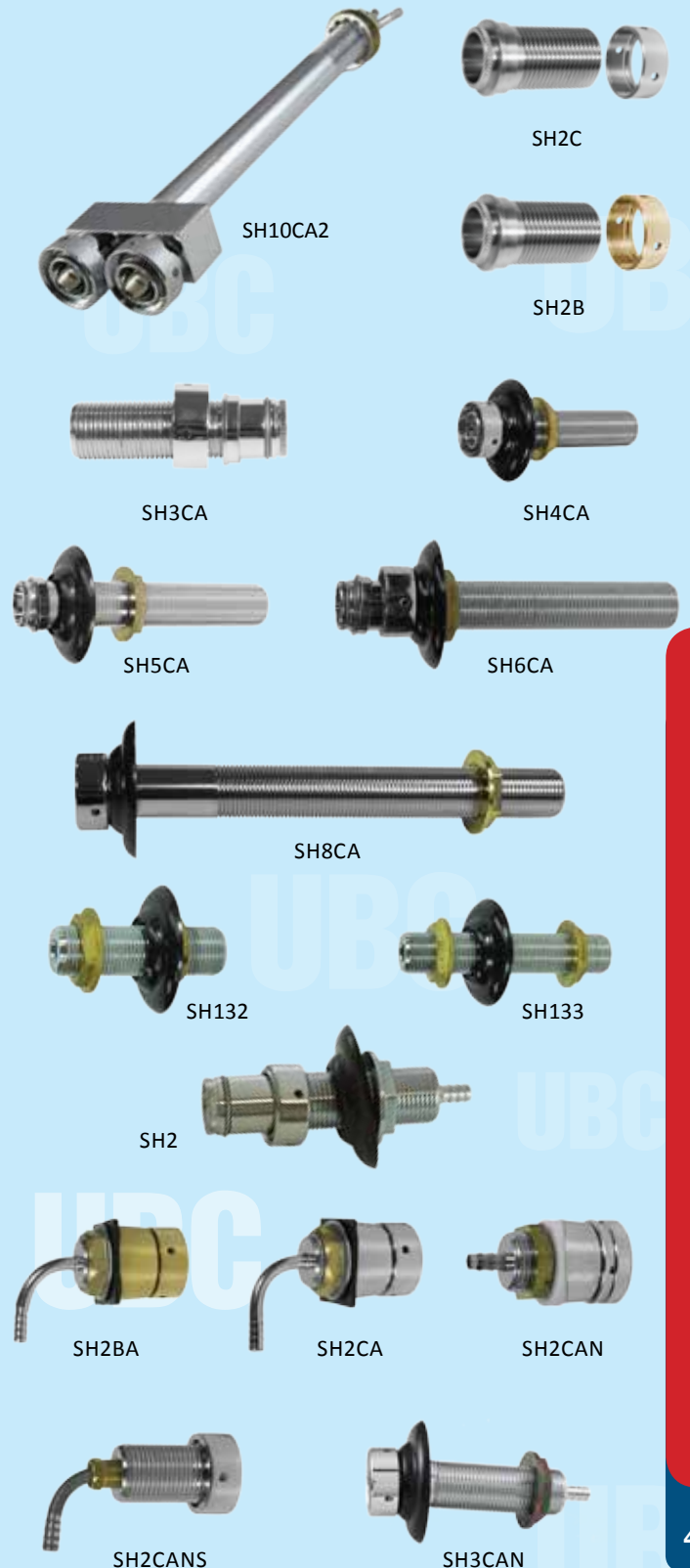

# FAUCETS AND SHANKS

## SHANKS & PARTS

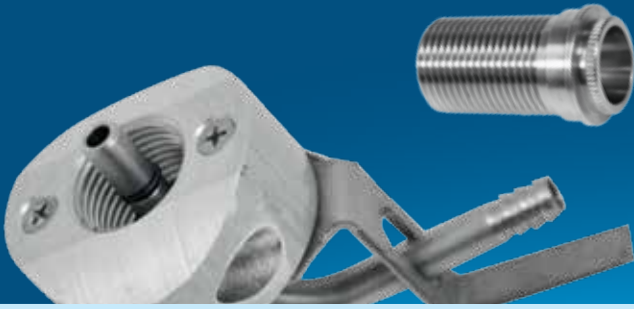

- 304 Stainless Steel or Brass shanks
- Available in a variety of sizes
- Chrome or Gold spacers

### Compression Shank Assembly

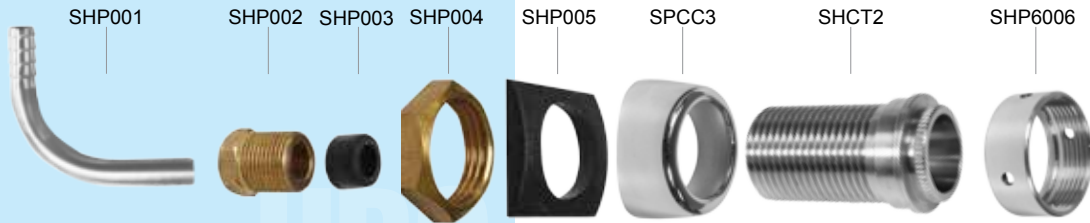

SHP0012

SHP0015

SHP006



SHP007

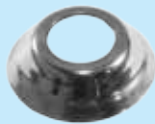

SHP009



SHP011



SHP010

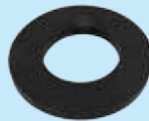

SHP013

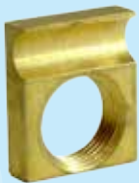

SHP228



SHP7007



SHSPMA

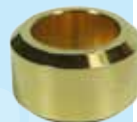

SPB1

### Shank Replacement Parts

Part No.	Description
SHCT2	Compression Shank - 1 3/4"
SHP001	SS 3/16" Tube x 3/16" Barb Elbow
SHP012	Locking Flange for Wall Shank Assembly
SHP015	Plastic Black Outer Flange - 4"
SHP002	Compression Nut
SHP003	Grommet Gland
SHP003E	Grommet Gland for Indented European Shank
SHP004	Lock Nut for Tower
SHP005	Plastic Spacer
SHP006	Sleeve
SHP007	Snap Ring
SHP009	SS Outer Flange - 4"
SHP011	Brass Lock Nut
SHP010	7/8" Zink Lock Washer
SHP013	Cooler Coupling / Shank Washer
SHP228	Cold Block Brass
SHP6006	Chrome Coupling Nut
SHP7007	Brass Coupling Nut
SHSPMA	SPM Cold Block Assembly
SPB1	3/4" Brass Spacer
SPC2	3/4" Chrome Spacer
SPCC3	Curved Chrome Outer Flange - 3"



SPC2



SPCC3

# FAUCETS AND SHANKS

## FAUCETS

- 304 Grade Stainless Steel
- Gold plated Brass
- Chrome plated Brass



BF1001



BF1002  
BF1002SS



BF1003



BF1005



North American faucet  
with flow control

BF650SS

## Domestic Faucets

Part No.	Description
BF1001	Polished Brass, Chrome plated, Brass Lever
BF1002	Polished Brass, Chrome plated, St. Steel Lever
BF1002SS	Polished Stainless Steel
BF1003	Polished Brass, Brass Lever
BF1005	Polished Brass, Chrome Plated, St. Steel Lever, made in Italy
BF650SS	Stainless steel, flow control
BFT1007	Chrome, Stainless Steel Spout, TOF
ET-40	Easy Tap, St. Steel
BF1003SS	Brass/Gold Plated, Stainless Steel
BFC304SS	Polished Stainless Steel, S/S Spout

## Stout Faucets

Part No.	Description
SF2000	Stout Brass Faucet
SF2001	Chrome Stout Faucet

## Stout Faucet Parts

Part No.	Description
SFP001	Stout Faucet Flow Straightener
SFP002	Stout Faucet O-Ring
SFP003	Stout Faucet Creamer Plate 0.3mm
SFP016	Stout Faucet St. Steel Nozzle

SF2000

SF2001



SFP001



SFP002



SFP003

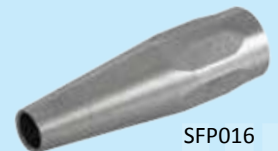

SFP016

## FAUCETS AND SHANKS

# FAUCETS AND ACCESSORIES

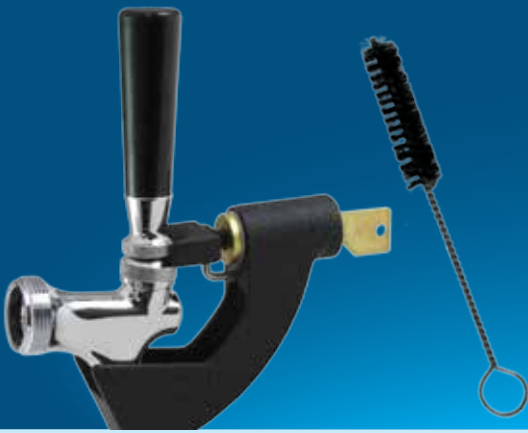

- 304 Grade Stainless Steel
- Gold plated Brass
- Chrome plated Brass



BFE3000



BFE3001



BFE3003



FL-02



BFP78



BFP701301



FP-01



FCA



TL237



TL271

## Euro Flow Control

Part No.	Description
BFE3000	Polished Brass, Gold plated, Flow Control, Self Closing, S/S Spout, with Shank
BFE3001	Polished Brass, Chrome plated, Flow Control, Self Closing, S/S Spout, with Shank
BFE3002	Euro Faucet, Ball type, Brass, Flow Control, with Shank
BFE3003	Euro Faucet, Ball type, Brass, Chrome plated, Flow Control, with Shank

## Faucet Accessories

Part No.	Description
BFP78	Stainless Steel Growler Tube Filler for Domestic Faucet
BFP70130	Faucet Plug, Brass
FCA	Flow Control Adapter
FL-02	Faucet Lock with Nozzle Cover
FP-01	Faucet Brush Plug
FP-02	Faucet Rubber Plug
TL237	Faucet Brush, Double Sided
TL271	Faucet Brush



# DRIP TRAYS

## Drip Trays

- Complete line of 304 Stainless Steel drip trays
- Drip Trays for both permanent and mobile situations
- Glass Rinser options available for all drip trays

■ <b>Countertop</b> Drip Trays.....	46
■ <b>Platform</b> Drip Trays.....	47
■ <b>Wall Mount</b> Drip Trays.....	48
■ <b>Drip Tray</b> Parts.....	48
■ <b>Clamp-on</b> Drip Trays.....	49

**NEW  
ARRIVAL**

## DRIP TRAYS

# COUNTERTOP DRIP TRAYS

- Designed for permanent or mobile use
- 304 Grade Stainless Steel
- Available with or without a glass rinsers
- Variety of sizes and shapes



Part No.	L length	W idth	Rinsers
DTU45X7SS	45"	7"	
DTU45X7SS-CR	45"	7"	✓
DTU45X7SS-SR	45"	7"	✓
DTU48X7SS	48"	7"	
DTU48X7SS-CR	48"	7"	✓
DTU48X7SS-SR	48"	7"	✓
DTU54X7SS	54"	7"	
DTU54X7SS-CR	54"	7"	✓
DTU54X7SS-SR	54"	7"	✓

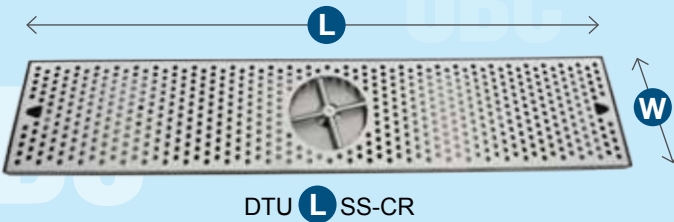
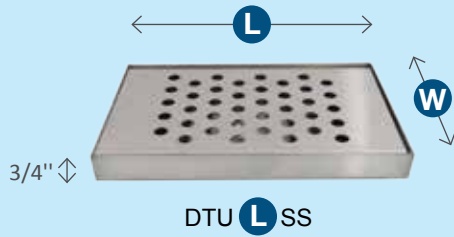

## Countertop Drip Trays

Part No.	L length	W idth	Rinsers
DTU10x5SS-ND	10"	5 1/2"	
DTU10x5SS	10"	5 1/2"	
DTU15x5SSND	15"	5 1/2"	
DTU15x5SS	24"	5 1/2"	
DTU24x5SS	24"	5 1/2"	
DTU30x5SS	30"	5 1/2"	
DTU36x5SS	36"	5 1/2"	
DTU12X7SS-ND	12"	7"	
DTU16X8SS	16"	7"	
DTU16X8SS-ND	16"	7"	
DTU20X7SS	20"	7"	✓
DTU20X7SS-CR	20"	7"	✓
DTU20x7SS-SR	20"	7"	
DTU24X7SS	24"	7"	✓
DTU24X7SS-CR	24"	7"	✓
DTU24x7SS-SR	24"	7"	
DTU30X7SS	30"	7"	✓
DTU30X7SS-CR	30"	7"	✓
DTU30x7SS-SR	30"	7"	
DTU36X7SS	36"	7"	✓
DTU36X7SS-CR	36"	7"	✓
DTU36X7SS-SR	36"	7"	

### Available finishing



Color Portfolio is on located on page 4 for many more colors. Special rates and lead time may apply

All Drip Trays come standard with drain

# DRIP TRAYS

## PLATFORM DRIP TRAYS



- Designed for beer tower to be mounted on top of the tray
- Keeps condensation and spillage away from countertop
- Ideal for ICE towers

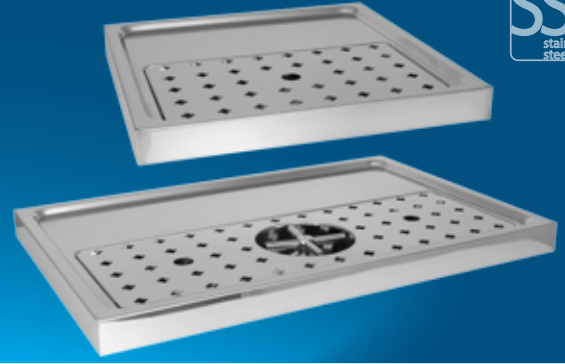

### Platform Drip Trays

Part No.	L <sup>ength</sup>	W <sup>idth</sup>	Rinser
DTF16	15 3/4"	15 3/4"	
DTF24	23 5/8"	15 3/4"	
DTF28	27 9/16"	15 3/4"	
DTF32	31 1/2"	15 3/4"	
DTF40	39 3/8"	15 3/4"	
DTF16R	15 3/4"	15 3/4"	✓
DTF24R	23 5/8"	15 3/4"	✓
DTF28R	27 9/16"	15 3/4"	✓
DTF32R	31 1/2"	15 3/4"	✓
DTF40R	39 3/8"	15 3/4"	✓
DTFC32R	31 1/2"	15 5/8"	✓
DTFC40R	39 3/8"	15 5/8"	✓
DTFC48R	47 1/2"	19 5/8"	✓



DTF L



DTF L R

### Cut Out Drip Trays

Part No.	L <sup>ength</sup>	W <sup>idth</sup>	Rinser
DTU20X7SS-COSR	20"	7"	✓
DTU28x10CC-COSR	28"	10"	✓
DTU28x10SSG-COSR	28"	10"	✓
DTU33x10SS-COSR	33"	10"	✓

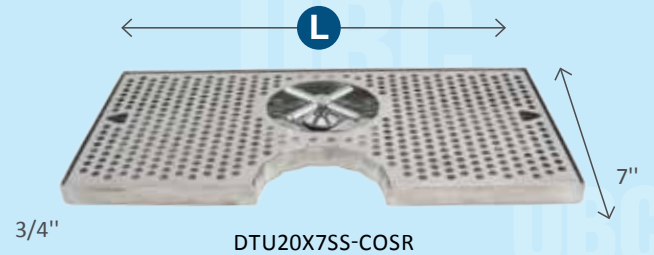

DTU20X7SS-COSR



## DRIP TRAYS

# DRIP TRAY WALL MOUNTS & DRIP TRAY PARTS

- Designed for permanent or mobile use
- 304 Grade Stainless Steel
- Available with or without a glass rinser
- Variety of sizes and shapes



DTWM24SS



\*NOTE: Drip Tray Wall Mounts do not come standard with faucets or holes. Please advise your sales representative of how you would like your Drip Tray Wall Mount configured.

## Drip Tray Wall Mounts

Part No.	Faucets	Length	Width	Height
DTWM8SS	Up to 3	8"	6 1/2"	14"
DTWM15SS	Up to 5	15"	6 1/2"	14"
DTWM24SS	Up to 8	24"	6 1/2"	14"
DTWM30SS	Up to 10	30"	6 1/2"	14"
DTWM36SS	Up to 12	36"	6 1/2"	14"

## Drip Tray Parts

Part No.	Description
DTP002B	2" Threaded Metal Drain
DTP004B	4" Threaded Metal Drain
DTP006M	6.5" Threaded Metal Drain
DTP004P	4" Threaded Plastic Drain
DTP006P	6" Threaded Plastic Drain
DTP100D	Female Metal Drain Fitting for 1/2" Hose
DTP205F	Female Drain Fitting for 1/2" Hose - Plastic Flange Adapter
JGPI451214FS	Gray Acetal Female Connector 3/8" x 1/2" BSPP
DTP-RIN	Metal Rinser Assembly
DTPC-RINP	Plastic Rinser Assembly
DTPC-RINP	Plastic Rinser Assembly

All Drip Trays come standard with drain



DTP002B

DTP006M



DTP004P

DTP006P



DTP100D

JGPI451214FS



DTP-RIN



DTPC-RINP

TOLL FREE: 1 (866) 995-9965, [www.beer-co.ca](http://www.beer-co.ca)



# DRIP TRAYS

## CLAMP-ON DRIP TRAYS



- Ideal solution for mobile or special event
- Designed for use with various towers
- Available in Chrome or Black finishing
- Stainless Steel drip tray grid

### Clamp-on Drip Trays

Part No.	Description
DTB9	9" x 6" clamp-on black
DTC9	9" x 6" clamp-on chrome



**NOTE:** Clamp-on Drip Tray can hold all American, Gothic, Cobra and Milano towers



Available with  
Branding on Page 110

# GLYCOL POWER PACKS

## Beer towers

1 to 14 faucets,  
Air or Glycol cooled to reduce foam  
while pouring

## Drip tray

Various sizes to fit your  
counter, glass rinser as an  
option



## Glycol Power Packs

- Easier to install, service and maintain
- Large condenser for hot ambient conditions
- High-Efficiency Evaporator shaped for optimal use of the glycol bath
- Digital thermostat for easier maintenance
- Environmentally friendly HFC-Free insulation
- 2-Tier Quality control (factory testing and pre-shipment testing)

### Flow-Of-Beer Detector

Keeps the line full while changing the keg to minimize loss of beer



### Draught Beer Storage 2-3°C (36-38F)

Beer is stored at the right temperature to preserve its original taste



### Regulator Panel

Allows different pressures for different beer styles

### Gas Blender

Blends CO2 and Nitrogen in required proportion to prevent beer deterioration

### Glycol chiller (Power Pack)

Keeps the temperature of the beer within the Trunk Line and Beer Tower at 2-3°C (36-38F)

CO2 or Nitrogen Gas Tanks

Pre-mixed gas tanks (CO2 + Nitrogen)

### Trunk line

4 to 14 beer lines, glycol circulates inside to keep beer temperature 2-3°C (36-38F)

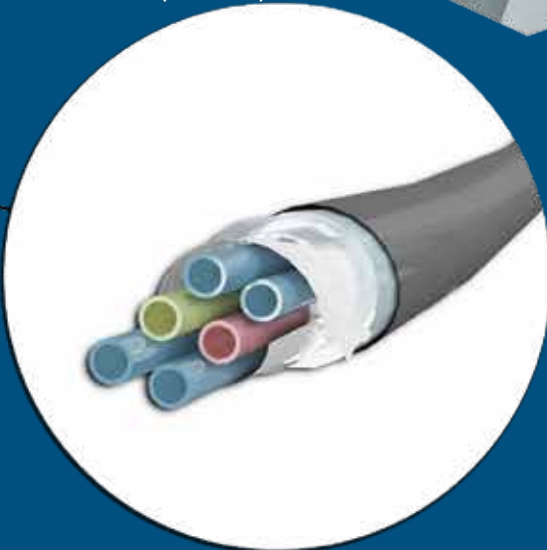

# BEER AND BEVERAGE COOLING SYSTEMS

## GLYCOL POWER PACKS



- Vertical or horizontal body for a better use of available space
- Operation distance up to 450 ft
- Digital thermostats on all models
- Optional 6" legs



 **KG-1/6VP**  
(Vertical Pump)

 **H35G-3/8VP**  
(Vertical Pump)



 **H35G-3/8GP**  
(Rotary Vane Pump)

 **G30-3/8GP**  
(Rotary Vane Pump)

NOTE: This Glycol Deck unit has a sealed bath



Legs for Glycol Decks  
are optional

## Glycol Power Packs

Name	KG-1/6VP	H35G-3/8VP	H35G-3/8GP	G30-3/8GP
Part Number	KG-1/6VP	H35G-3/8VP	H35G-3/8GP	G30-3/8GP
Maximum Distance, ft	25'	75'	125'	125'
Capacity, BTU/hr evap 20f	1150	2690	2690	2600
Glycol tank capacity, gal	2	5	5	2.9
Dedicated Circuit, amp	15 ⚡			
Compressor Power, hp	1/7+	3/8	3/8	3/8
Pump Type	MID-5 or FloJet SPC42		50-100gal/hr	
Optional Additional Pump	n/a			
Thermostat	Digital			
Refrigerant	R134a			
Legs (optional)	n/a	6"	6"	6"
Dimensions <b>W</b> x <b>D</b> x <b>H</b> , in	17x19x17	28 x19x18	28x19x19	27x28x20
Weight Gross/Net, lbs	42/46	85/103	95/102	95/102

# BEER AND BEVERAGE COOLING SYSTEMS

## GLYCOL POWER PACKS

- Vertical or horizontal body for a better use of available space
- Operation distance up to 450 ft
- Digital thermostats on all models
- Optional 6" legs



H75G-3/8VP  
(Vertical Pump)



H75G-3/8GP  
(Rotary Vane Pump)

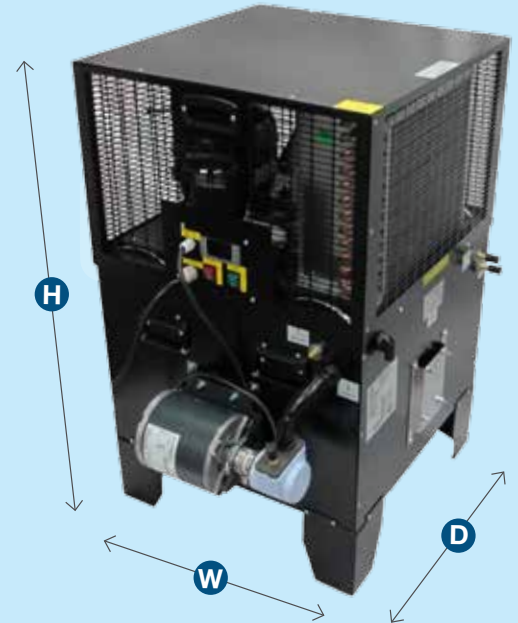

EXTRA 1/2 GP  
(Rotary Vane Pump)

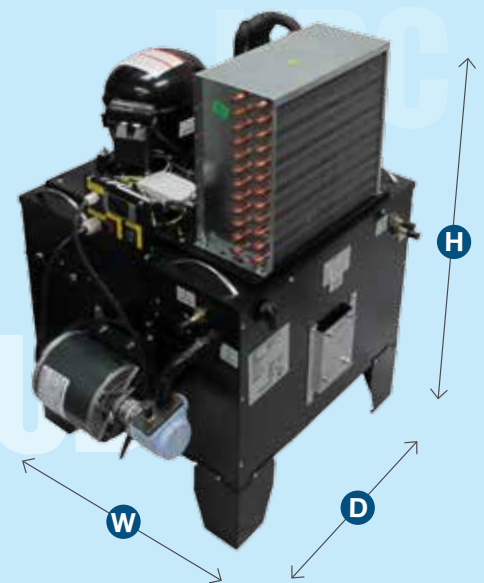

EXTRA 3/4 GP  
(Rotary Vane Pump)

Name	H75G-3/8VP	H75G-3/8GP	EXTRA 1/2 GP	EXTRA 3/4 GP
Part Number	H75G-3/8VP	H75G-3/8GP	EG-1/2P	EG-3/4P
Maximum Distance, ft	75'	125'	250'	450'
Capacity, BTU/hr evap 20f	2690	2690	3900	5500
Glycol tank capacity, gal	7		18	
Dedicated Circuit, amp	15 Ⓜ		20 Ⓜ	
Compressor Power, hp	3/8	3/8	1/2	3/4
Pump Type	FloJet SPC42	50-100gal/hr	80gal/hr	
Optional Additional Pump	n/a		80gal/hr	
Thermostat	Digital			
Refrigerant	R134a			
Legs (optional)	6"			
Dimensions <b>W</b> x <b>D</b> x <b>H</b> , in	15x18x29	15x18x28	28x23x30	
Weight Gross/Net, lbs	86/94	96/104	166/144	176/154

# DRAUGHT BEER ICE BANK FLASH COOLERS

## Beer towers

1 to 14 faucets,  
Air or Glycol cooled to reduce foam  
while pouring

## Drip tray

Various sizes to fit your  
counter, glass rinser as an  
option



## Flash Cooler

Cools beer and beverages  
to 2-3°C (36-38F) from any  
room temperature

CO2 or Nitrogen  
Gas Tanks

## Draught Beer Ice Bank Flash Coolers

- Suitable for beer, beverages or wine
- Easy-to-install chillers ideal for mobile and special event solutions
- Can be added to an existing remote glycol system for additional cooling capacity
- Highest climate class - class 4 (outdoor use)

# DRAUGHT BEER ICE BANK / FLASH COOLERS

## FLASH COOLERS

- Suitable for cooling and dispensing beer, beverages or wine
- Can be used as a mobile solution for special events or patio events
- Can be added to a remote glycol system for additional cooling capacity



## Flash Coolers

Name	Kalinka 2	Tayfun T75F
Part Number	KF-1/6T2	T75F-1/4T3
Maximum Distance, Ft	25'	25'
Capacity-Compressor (evap 20F), BTU/hr	1150	1900
Capacity-Ice Bank, BTU/hr	924	3100
Ice bank, Lbs	6.6	22
Dedicated Circuit, Amp	15	
Voltage, Volt/Hz	115/60	
Power consumption, Watt	300	550
Compressor Power, HP	1/6hp	1/4hp
Thermostat, Type	Digital	Manual
Number of Product Lines, Coils	2	3
Coil Diameter, ID-OD, In	1/4" -5/16"	
Coil Length (total), Ft	30	120
Pump Type	MID-5	FloJet SPC42
Pump Flow rate, Gal/Hr (water)	95	240
Refrigerant, Type	R134a	
Dimensions <b>W</b> x <b>D</b> x <b>H</b> , in	18x22x12.3	15x16x28
Weight Net/Gross, Lbs	50/56	75/84



TAYFUN T75F  
3 product lines



KALINKA 2



# DRAUGHT BEER ICE BANK / FLASH COOLERS

## FLASH COOLERS



- Suitable for cooling and dispensing beer, beverages or wine
- Can be used as a mobile solution for special events or patio events
- Can be added to a remote glycol system for additional cooling capacity



TAYFUN T120F  
4 product lines



## Flash Coolers

Name	Tayfun T120F	Tayfun T160F
Part Number	T120F-1/3T4	T160F-1/2T6
Maximum Distance, Ft	25'	25'
Capacity-Compressor (evap 20F), BTU/hr	2600	3100
Capacity-Ice Bank, BTU/hr	5500	7500
Ice bank, Lbs	44	53
Dedicated Circuit, Amp	15	
Voltage, Volt/Hz	115/60	
Power consumption, Watt	750	800
Compressor Power, HP	1/3hp	1/2hp
Thermostat, Type	Manual	
Number of Product Lines, Coils	4	6
Coil Diameter, ID-OD, In	1/4" -5/16"	
Coil Length (total), Ft	200	350
Pump Type	FloJet SPC42	
Pump Flow rate, Gal/Hr (water)	240	
Refrigerant, Type	R134a	
Dimensions W x D x H, in	17x19x30	32x19x23
Weight Net/Gross, Lbs	97/106	125/136



TAYFUN T160F  
6 product lines



# DRAUGHT BEER ICE BANK / FLASH COOLERS

## FLASH COOLERS

- Suitable for cooling and dispensing beer, beverages or wine
- Can be used as a mobile solution for special events or patio events
- Can be added to a remote glycol system for additional cooling capacity



## Flash Coolers

Name	Tayfun V200F	Tayfun T220F
Part Number	V200EX-3/4T2	T220F-1/2T14
Maximum Distance, Ft	N/A	25'
Capacity-Compressor (evap 20F), TU/hr	5700	4500
Capacity-Ice Bank, BTU/hr	10500	9000
Ice bank, Lbs	75	64
Dedicated Circuit, Amp	15	
Voltage, Volt/Hz	115/60	
Compressor Power, HP	3/4hp	1/2hp
Thermostat, Type	Manual	
Number of product lines, coils	1 to 4	14
Coil Diameter, ID-OD, In	1/4" - 5/16"	
Coil Length (total), Ft	180	420
Pump Type	MID-5	Flojet SPC42
Pump Flow rate, Gal/Hr (water)	95	240
Refrigerant, Type	R134-a	
Dimensions <b>W</b> x <b>D</b> x <b>H</b> , in	28x26x43	22x24x35
Weight Gross/Net, Lbs		145/162



TAYFUN T220  
14 product lines



TAYFUN V200F  
2 product lines  
(tower sold separately)

# BEVERAGE COOLING & DISPENSING

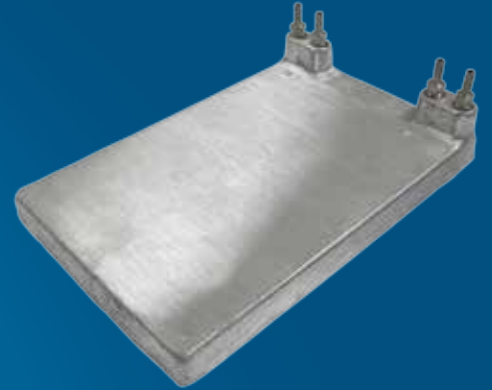

## Beverage Cooling & Dispensing

UBC line of portable and remote coolers and accessories for post-mix beverage dispensing systems, juice and tea dispensers, filtered carbonated water systems and for other bag-in-box beverages.

- **Beverage and Carbonator Coolers** ..... 59
- **Beverage System Parts** ..... 60

## BEVERAGE COOLING AND DISPENSING

# BEVERAGE AND CARBONATOR COOLERS

- Portable cooling and carbonation of water and soft drinks
- Remote cooling and carbonation of bag-in-box drinks

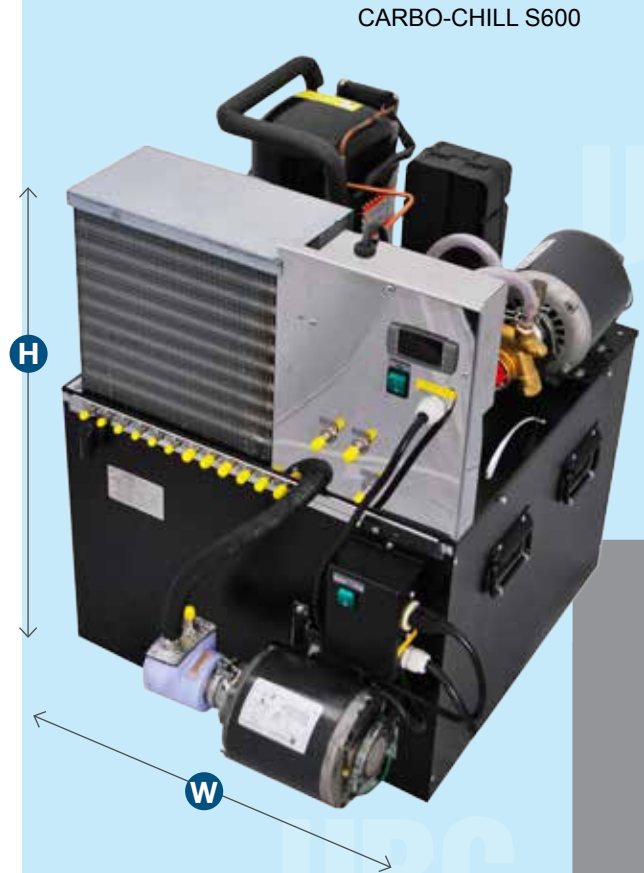

Name	Carbo-Chill 100	Carbo-Chill 600
Part Number	S100C-1/4T2	S600-1/2T6
Built-in Carbonator	YES	YES
Maximum Distance, Ft		
Capacity-Compressor (evap 20F), BTU/hr	1500	3900
Capacity-Ice Bank, BTU/hr	1400	6300
Ice bank, Lbs	10	45
Dedicated Circuit, Amp		
Voltage, Volt/Hz		
Power consumption, Watt	450	800
Compressor Power, HP	1/4	1/2
Thermostat, Type	Digital	Digital
Number of product lines, coils	2	6
Coil Diameter, ID-OD, In	1/4"-5/16"	
Pump Type	Agitator	Gear
Pump Flow rate, Gal/Hr (water)	95	100
Refrigerant, Type		
Dimensions <b>W</b> x <b>D</b> x <b>H</b> , In	14x19x18	18x24x29
Weight Gross/Net, Lbs	85/80	185/175

## Complementary Product

- Designed for Still Water, Carbonated Water and Wine dispensing
- Stylish design
- Easy to operate
- Made in Europe

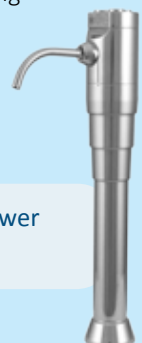

Xenia Tower  
Page 26

# BEVERAGE COOLING AND DISPENSING BEVERAGE SYSTEM PARTS

- Parts and accessories for remote bag-in-box systems
- Portable bottle water dispensers
- Parts for drop-in ice bin coolers

CARB-400397



CARB-436002

BP16-1404



PV42

BPP5000-130



BPP01500-030A

PG56



BPF001

BPF002



DTP01752-327C



DTP01752-307C

## Carbonators

Part No.	Description
BP16-1404	Carbonator, Replacement Probe Assembly
CARB-436002	Carbonator, Standard, McCann
CARB-400397	Carbonator, BigMac, McCann

## FloJet Pumps

Part No.	Description
PV42	Vertical Agitator Pump, FloJet SPC42
BPP5000-130	Syrup pump, FLOJET
BPP01500-030A	Transfer Valve, Regular
PG56	Beer pump, FLOJET

## Pump Fittings

Part No.	Description
BPF001	Brass 1/4" elbow hose barb inlet with shut-off
BPF002	Brass 1/4" "T" hose barb inlet with shut-off
BPF003	Brass 1/4" strait hose barb inlet with shut-off

## In-line Regulators

Part No.	Description
DTP01752-327C	In-line Water Pressure Regulator, 30 psi
DTP01752-307C	In-line Water Pressure Regulator, 50 psi, 3/8" Barb
DTP01750-301C	In-line Water Pressure Regulator, 50 psi, 1/4" Barb

# BEVERAGE COOLING AND DISPENSING BEVERAGE SYSTEM PARTS

- Parts and accessories for remote bag-in-box systems
- Portable bottle water dispensers
- Parts for drop-in ice bin coolers



**NEW  
ARRIVAL**

## Water Filtration

Part No.	Description
FHV3NN	3-stage water filtration system, 0.3 Gpm, removes chlorine and by-products, ECOSOFT
CHV3ECOEXP	Replaceable filter pack for 3-stage water filters, ECOSOFT
ROBUSTEN	Reverse osmosis water filtration system, 0.3 Gpm, removes total dissolved solids, nitrates, chlorides, sulfates, hydrocarbonates and hardness, ECOSOFT ROBUST
TW1812100	Membrane, ECOSOFT ROBUST



FHV3NN



TW1812100

## Connectors

Part No.	Description
BPC001	Liqui-box QCD II Bag-in-Box connector
BPC002	CC Bag-in-Box connector
BPC003	Ball lock GAS quick disconnect, 1/4" barb
BPC004	Ball lock LIQUID quick disconnect, 1/4" barb
BPC005	Pin lock GAS quick disconnect, 1/4" barb
BPC006	Pin lock LIQUID quick disconnect, 1/4" barb



BPC001



BPC002



BPC003



BPC004



BPC005



BPC006

## Cold Plates

Part No.	Description
JBA401000	8" x 12", 1 Product, 1/4" Barb
JBA402000	8" x 12", 2 Products, 1/4" Barb
JBA404000	10" x 15", 2 Products, 1/4" Barb
JBA404003	8" x 14", 3 Products, 1/4" Barb
JBA404008	8" x 14", 8 Products, 1/4" Barb

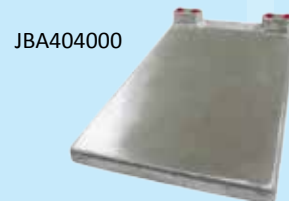

JBA404000

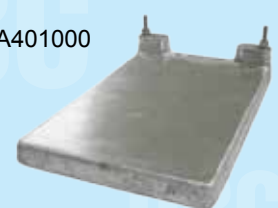

JBA401000

## Bottle Water Dispensers

Part No.	Description
BWD1000A	FloJet single inlet bottle water dispenser
BWD2000A	FloJet double inlet bottle water dispenser

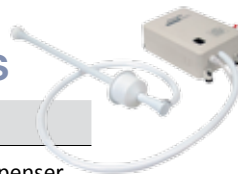

## Bag-in-Box Rack

RK2-BIFJG

Part No.	Description
RK2-BIFJG	2-box inclined shelf



# WINE-ON-TAP SYSTEMS

## Wine-On-Tap System

Wine-on-tap means a perfect pour, every time, for any length of time. Exactly the way the winemaker intended.

- An inert gas pushes the wine out of the keg, preserving the wine remaining in the keg for months.
- Wine will not oxidize and will never be corked or experience bottle variation or any other flaws due to packaging.

# WINE-ON-TAP SYSTEMS

## WINE-ON-TAP COOLERS

- Easy-to-install coolers ideal for wine-on-tap dispense
- 316 Stainless Steel product lines suitable for wine dispensing
- Digital thermostat



Name	Kalinka 2	Tayfun T75F	Tayfun T120F
Part Number	KF-1/6T2	T75F-1/4T3	T120F-1/3T4
Maximum Distance, Ft	25'	25'	25'
Capacity-Compressor (evap 20F), BTU/hr	1150	1900	2600
Capacity-Ice Bank, BTU/hr	924	3100	5500
Ice bank, Lbs	6.6	22	44
Dedicated Circuit, Amp	15		
Voltage, Volt/Hz	115/60		
Power consumption, Watt	300	550	750
Compressor Power, HP	1/7+hp	1/4hp	1/3hp
Thermostat, Type	Digital		
Number of product lines, coils	2	3	4
Coil Diameter, ID-OD, In	1/4" -5/16"		
Coil Length (total), Ft	30	120	200
Pump Type	MID-5	FloJet SPC42	
Pump Flow rate, Gal/Hr (water)	95	240	
Refrigerant, Type	R134a		
Dimensions <b>W</b> x <b>D</b> x <b>H</b> , in	18x22x12.3	15x16x28	17x19x30
Weight Gross/Net, Lbs	50/56	75/84	97/106

## Wine towers



**COBRA 1, 2, 3 & 4**  
with & without single sided LED's



**HAVANA 3, 4, 5 & 6**  
with & without single sided LED's

**FALCO 1** with & without double sided LED plus 2 & 3 with & without single sided LED's

# DRAUGHT BEER DISPENSE SYSTEM COMPONENTS



## Draught Beer Dispense System Components

- **Kege**s and Accessories ..... 65
- **Primary** Gas Regulators ..... 67
- **Secondary** Gas Regulators ..... 68
- **Regulator Parts** & Air Distributors ..... 69
- **Regulator** Panels ..... 71
- **Gas** Blenders ..... 73
- **Pumps** & Motors ..... 74
- **Keg** Couplers ..... 75
- **Draught Beer** System Parts ..... 78
- **John Guest** Fittings ..... 79
- **Fittings** ..... 82
- **Trunkline** and Tubing ..... 84



# DRAUGHT BEER DISPENSE SYSTEM COMPONENTS

## KEGS

NEW  
ARRIVAL

- 304 Stainless Steel kegs
- Generic or Micromatic spears
- Stackable or non-stackable
- Available embossed and branded



## 304 Stainless Steel Kegs

Part No.	Description
KG(H)-D1/6S	Stainless Steel Keg with MicroMatic D Fitting, 1/6 bbl, Stackable, AISI 304
KG(H)-D1/4S	Stainless Steel Keg with MicroMatic D Fitting, 1/4 bbl, Stackable, AISI 304
KG(H)-D50	Stainless Steel Keg with D Fitting, 50L, Stackable, AISI 304
KG-D58	Stainless Steel Keg with D Fitting, 58L, Unstackable, AISI 304



Custom Keg Chime Embossing  
(min. quantity requirements will apply)



# DRAUGHT BEER DISPENSE SYSTEM COMPONENTS

## KEG ACCESSORIES



- Keg Accessories
- Keg Stackers
- Keg Spears and Parts



TL19A



KJ1/4-1/2



KS1-50

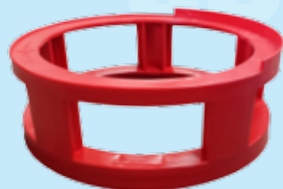

KS2-50



KS1-1/6



KS2-1/6



KD3

## Tamper Evident Keg Caps

Part No.	Description
KGC-D-BLACK	Type D Keg Cap, No Logo, Black
KGC-D-BLUE	Type D Keg Cap, No Logo, Blue
KGC-D-GREEN	Type D Keg Cap, No Logo, Green
KGC-D-RED	Type D Keg Cap, No Logo, Red
KGC-D-WHITE	Type D Keg Cap, No Logo, White
KGC-D-YELLOW	Type D Keg Cap, No Logo, Yellow
KGC-S	Type S Keg Cap, No Logo

## Keg Accessories

Part No.	Description
TL19A	Keg Digital Scale, 100kg/220lbs
KJ1/4-1/2	Keg Jacket, Insulated for 1/2 or 1/4 Barrels
KS1-50	Keg Stacker, Height 1.5", 50L Kegs
KS2-50	Keg Stacker, Height 6", 50L Kegs
KS1-1/6	Keg Stacker, Sixtel, 1/6 bbl Keg
KS2-1/6	Keg Spacer, Sixtel, 1/6 bbl Keg
KD3	Keg Dolly

## Keg Spears and Parts

Part No.	Description
KGP-DCN473	D Type Keg Spear
TLK-D/S	Keg Compression Tool for D and S Valve
KGP06-2058	D Type, Spear Retaining Ring
KGP45-0017	D Type, Spear O-ring
KGP47-0001	D Type, Spear Beer Spring
KGP47-0003	D Type, Spear St. Steel Ball
KGP50-1125	D Type, Spear CO2 Valve
KGP-DCN515	D Type, 1/6 Keg Spear, 515.5mm
KGP-DCN552	D Type, 1/4 & 1/2 Keg Spear, 552mm

# DRAUGHT BEER DISPENSE SYSTEM COMPONENTS

## PRIMARY GAS REGULATORS

- Complete line of domestic and European primary and secondary gas regulators
- Regulator parts and components



### Primary CO<sub>2</sub> Regulators

Part No.	Description
RGC-CH-60	Primary CO <sub>2</sub> , 60psi, Economy
RGC-T2	Primary CO <sub>2</sub> , 60psi, TapRite
RGC-T2HP	Primary CO <sub>2</sub> , 160psi, TapRite
RGCTOF-60	Primary CO <sub>2</sub> , 60psi, TOF
RGCM-60	Primary CO <sub>2</sub> , 60psi, MicroMatic
RGC-7422	Primary CO <sub>2</sub> , 2 Products, 60psi,

### Primary Nitrogen Regulators

Part No.	Description
RGNTOF-60	Primary N <sub>2</sub> , 60psi, TOF
RGN-CH-60	Primary N <sub>2</sub> , 60psi, Economy
RGN-T2	Primary N <sub>2</sub> , 60psi, TapRite
RGN-T2HP	Primary N <sub>2</sub> , 160psi, TapRite
RGNM-60	Primary N <sub>2</sub> , 60psi, MicroMatic
RGN-942BN	Primary N <sub>2</sub> , 120psi, MicroMatic



# DRAUGHT BEER DISPENSE SYSTEM COMPONENTS

## SECONDARY GAS REGULATORS



- Complete line of domestic and European primary and secondary gas regulators
- Regulator parts and components

### Regulator Fittings

Part No.	Description
RGPCO2-N	CO <sub>2</sub> bottle to N <sub>2</sub> regulator adapter
RGPN-CO2	N <sub>2</sub> bottle to CO <sub>2</sub> regulator adapter
RGP-COV	CO <sub>2</sub> changeover valve



RGPCO2-N

RGPN-CO2

RGP-COV



RGST-1BB2



RGSTOF-1BB2



RGST-1PB



RGSTOF-1BB



RGSM-1BP



RGSTOF-3BB



RGST-4PB



RGSM-5BP

### Secondary Regulators

Part No.			Description
TapRite	TOF	MicroMatic	
RGST-1PB	RGSTOF-1PB	RGSM-1PB	Secondary, 1 product, plug-barb
RGST-1BB	RGSTOF-1BB	RGSM-1BB	Secondary, 1 product, barb-barb
RGST-1BP	RGSTOF-1BP	RGSM-1BP	Secondary, 1 product, barb-plug
RGST-1BB2	RGSTOF-1BB2	-	Secondary, 1 product, 2 shut-offs, barb-barb
RGST-2PB	RGSTOF-2PB	RGSM-2PB	Secondary, 2 product, plug-barb
RGST-2BB	RGSTOF-2BB	RGSM-2BB	Secondary, 2 product, barb-barb
RGST-2BP	RGSTOF-2BP	RGSM-2BP	Secondary, 2 product, barb-plug
RGST-3PB	RGSTOF-3PB	RGSM-3PB	Secondary, 3 products, plug-barb
RGST-3BB	RGSTOF-3BB	RGSM-3BB	Secondary, 3 product, barb-barb
RGST-3BP	RGSTOF-3BP	RGSM-3BP	Secondary, 3 product, barb-plug
RGST-4PB	RGSTOF-4PB	RGSM-4PB	Secondary, 4 products, plug-barb
RGST-4BB	RGSTOF-4BB	RGSM-4BB	Secondary, 4 products, barb-barb
RGST-4BP	RGSTOF-4BP	RGSM-4BP	Secondary, 4 products, barb-plug
RGST-5PB	RGSTOF-5PB	RGSM-5PB	Secondary, 5 products, plug-barb
RGST-5BB	RGSTOF-5BB	RGSM-5BB	Secondary, 5 products, barb-barb
RGST-5BP	RGSTOF-5BP	RGSM-5BP	Secondary, 5 products, barb-plug

# DRAUGHT BEER DISPENSE SYSTEM COMPONENTS

## REGULATOR PARTS

- Full set of regulator parts and accessories
- Air distributor allows you to connect many different barrels from one CO2 primary regulator



### Regulator Parts

Part No.	Description
RGP294	CO2 Washer, Hard Fiber
RGP1024	CO2 Rubber Seal, TapRite
RGP1224	N Regulator O-Ring
RGP-P14	Plug 1/4"
RGP-S2	Safety Valve
RGP-Y14	Regulator Y Fitting 1/4"
RGP125-4B	Barbed Nipple 1/4"
RGP125-5B	Barbed Nipple 5/16"
RGP125-6B	Barbed Nipple 3/8"
RGPCO2	CO2 Regulator Nut and Nipple
RGP740-19	CO2 Nut and Nipple with Flat Seat
RGP740-20	Nitrogen Nut and Nipple with O-Ring
RGP-RGG	Rubber Jacket for Regulator Gauge
RGP6400P	Repair Kit for Primary Premium Regulator, MM
RGP6400S	Repair Kit for Secondary Premium Regulator, MM
RGP-TOFGG	Gauge Guard for TOF Regulator
RGP-TAPGG	Gauge Guard for TapRite Regulator
RGP-MMGG	SS Gauge Guard for MicroMatic Regulator
RGP-MB	Mounting Bracket for MM/CN



RGP294 RGP1024 RGP-P14



RGP-S2 RGP-Y14 RGP125-4B



RGP740-19 RGP740-20 RGP-RGG



RGP6400P RGP6400S



RGP-TOFGG RGP-TAPGG

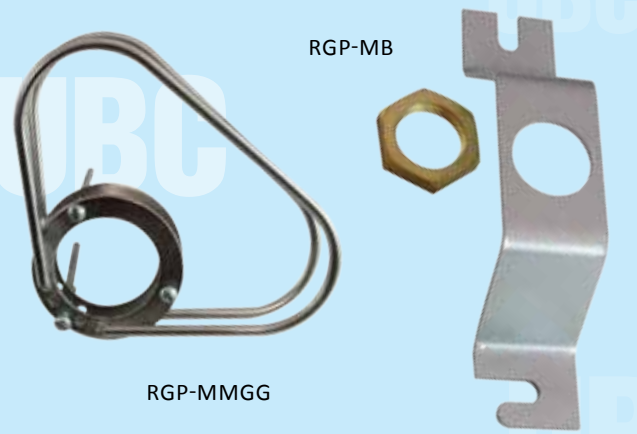

RGP-MMGG RGP-MB

# DRAUGHT BEER DISPENSE SYSTEM COMPONENTS

## SECONDARY GAS REGULATORS

- Air Distributors in various sizes
- Regulator parts and components



RGP121-B



RGP121-BL



RGP1600C14



RGP1600CA



RGP1600A



RGP6003-3000L



RGP740-502



RGPCO2-N



AD1742



AD1743



AD1744

## Regulator Parts

Part No.	Description
RGP121-B	Hex Nipple MPT/Union 1/4"
RGP121-BL	Hex Nipple MPT/Union 1/4", Left Hand Thread
RGP1600C	Shut-off Valve 5/16" Barb, Check Valve, Metal Knob
RGP1600C14	Shut-off Valve 1/4" Barb, Check Valve, Metal Knob
RGP1600A	Shut-off Valve 5/16" Barb, No Check Valve, TapRite
RGP1600CA	Shut-off Valve with Ball Check, 5/16" Barb, Metal Knob, Taprite
RGP1600NC	Shut-off Valve 5/16" Barb, No Check Valve, Metal Knob
RGP6003-3000L	3000lbs Regulator Gauge, Lefthand Thread
RGP6003-3000R	3000lbs Regulator Gauge, Righthand Thread
RGP7740-15	Regulator Repair Kit for CO2 and Secondary, TapRite
RGP7740-15N	Regulator Repair Kit for N, TapRite
RGP6400S	Repair Kit for Secondary Premium Regulator, MM
RGP740-502	60lbs Regulator Gauge
RGP740-503	160lbs Regulator Gauge
RGPN-CO2	N2 Bottle to CO2 Regulator Adapter
RGPCO2-N	CO2 Bottle to N2 Regulator Adapter

## Air Distributors

Part No.	Description
AD1742	Two-way Air Distributor
AD1743	Three-way Air Distributor
AD1744	Four-way Air Distributor
AD1745	Five-way Air Distributor

Standard manifold block comes with shut-off valves only. Safety valves, plugs and barbed nipples are ordered separately.

# DRAUGHT BEER DISPENSE SYSTEM COMPONENTS

## REGULATOR PANELS

- Secondary gas regulators, FOBs and beer pumps mounted on a metal panel for easy installation on the walk-in cooler interior wall
- Available custom assembled



### Regulator Panels

Part No.	Description
BP-S2	Secondary Panel with 2 Secondary Regulators
BP-SF1	Secondary Panel with 1 Secondary Regulator and 1 FOB, 3/8" ID Tubing
BP-SF2	Secondary Panel with 2 Secondary Regulators and 2 FOBs, 3/8" ID Tubing
BP-SF3	Secondary Panel with 3 Secondary Regulators and 3 FOBs, 3/8" ID Tubing
BP-SF4	Secondary Panel with 4 Secondary Regulators and 4 FOBs, 3/8" ID Tubing
BP-SF5	Secondary Panel with 1 Secondary Regulator and 2 FOBs
BP-SF6	Secondary Panel with 2 Secondary Regulators and 2 FOBs, 3/16" ID Tubing
BP-SF7	Secondary Panel with 2 Secondary Regulators and 2 FOBs, 3/8" ID Tubing, PP



BP-S2

All Regulator Panels come standard with 6ft. Beer Line, 3/8" Tail Piece and 7/8" Swivel Nut and 6ft. Gas Line.



BP-SF2

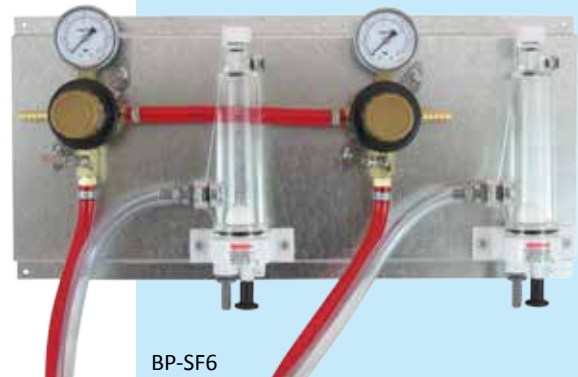

BP-SF6



BP-SF4

# DRAUGHT BEER DISPENSE SYSTEM COMPONENTS

## REGULATOR ASSEMBLIES



- Secondary gas regulators, FOBs and beer pumps mounted on a metal panel for easy installation on the walk-in cooler interior wall
- Available custom assembled

All Regulator Assemblies come standard with 6ft. Beer Line, 3/8" Tail Piece and 7/8" Swivel Nut and 6ft. Gas Line.

### Regulator Assemblies

Part No.	Description
BPP-L2-EBT	Lead Pump Panel with 2 Flojet Beer Pumps, 2 Secondary Regulators, 2 Tecflo FOBs and Manifold
BPP-L2-DELUXE	Deluxe Panel with 2 Flojet Beer Pumps, 2 Secondary Regulators, 2 FOBs, Beer Manifolds, Cleaning Heads
BPP-L2-EBT-MX	Lead Pump Panel with 2 Flojet Beer Pumps, 2 Secondary Regulators, 2 Tecflo FOBs



BPP-L2-EBT

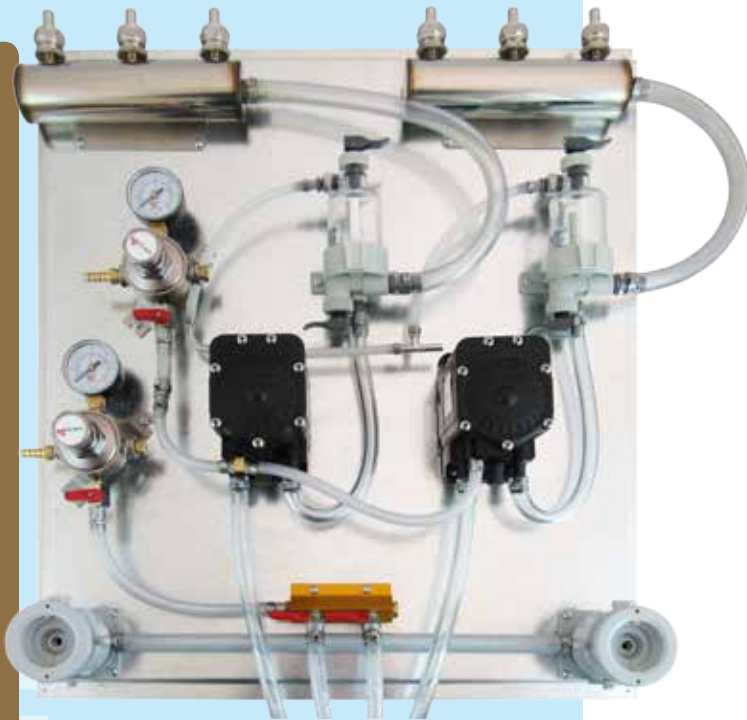

BPP-L2-DELUXE



BPP-L2-EBT-MX



# DRAUGHT BEER DISPENSE SYSTEM COMPONENTS

## GAS BLENDERS

- Specially designed to fill the needs of the Canadian and U.S. beer dispensing market
- McDantum blending panels include gauges to adjust pressure

### McDantim Trumix™ Blending Panel

The McDantim Trumix™ Blending Panel was specifically designed to fill the needs of the U.S. Beer Dispensing Market. The Panel is a small wall-mounted unit that tucks neatly and safely out of the way. It is easy to install and is extremely dependable. The Trumix™ requires no electricity, on-going maintenance or adjustment. It can be used equally well with all sources of clean nitrogen and CO2 including high pressure cylinders, bulk tanks or separators.

McDantum blending panels include gauges to adjust pressure.

Part No.	Description
TM100	Single Outlet Blending Panel, up to 15 kegs/hr
TM100HF	Single Outlet Blending Panel, up to 30 kegs/hr
TM200	Double Outlet Blending Panel, up to 30 kegs/hr
TM200HF	Double Outlet Blending Panel, up to 60 kegs/hr
TM300	Triple Outlet Blending Panel
MV013	1/4" T w/Check Valve

### In-line leak indicator

With McDantim's In-Line Leak Indicator (MV035), within seconds you can see if you have a leak and gauge how big that leak is.

Part No.	Description
MV035	Double In-line leak indicator
MV039	Single In-line leak indicator



TM100



TM200



TM300



MV035



MV039

# MOBILE AND EVENT BEER COOLING & DISPENSING PUMPS AND MOTORS



PM1-3

- Flojet Beer pumps
- Replacement pumps and motors for UBC beer beverage equipment

## Rotary Vane Pumps & Motors

Part No.	Description
PMA-ASM	100 GPH Pump and Motor Assembly (complete with fittings and clamp)
PMA75-ASM	75 GPH Pump and Motor Assembly (complete with fittings and clamp)
PMA45-ASM	45 GPH Pump and Motor Assembly (complete with fittings and clamp)
PP100	Rotary Vane Pump, Procon/Fluid-o-tech Pump 100 GPH
PP75	Rotary Vane Pump, Procon/Fluid-o-tech Pump 75 GPH
PP45	Rotary Vane Pump, Procon/Fluid-o-tech Pump 45 GPH
PM1-3	Pump Motor, 1/3HP
EC9W	Electric 9W Fan Motor
EC25W	Electric 25W Fan Motor

## Pump Parts

Part No.	Description
PA291	Dumper Coupling
PA200	Dumper Coupling Assembly
P1113	V-Band Clamp
PAJ	Foam Pump Jacket
D125-6C	Barb Male Pipe Connector 3/8" x 3/8"

## Vertical Agitator Pump

Part No.	Description
PV42	Vertical Pump Flojet SPC42
PV05	Vertical Pump Saber MID-05

## Beer Pump

Part No.	Description
PG56	Flojet Beer Pump
PG56-100	Flojet Flow Reversal Valve

# DRAUGHT BEER DISPENSE SYSTEM COMPONENTS

## KEG COUPLERS

- Complete line of domestic and European keg couplers
- Brass or stainless steel body and probe
- Different types of handles available

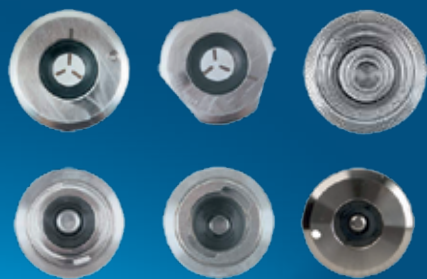

CHT-D



CHT-S



CHT-G



CHT-U

### TapRite Keg Couplers

Part No.	Description
CHT-D	D type
CHT-S	S type (Stella Artois, Beck's, Leffe, Czechvar)
CHT-G	G type (Bass, Grolsch, Tennent's, Boddington's)
CHT-U	U type (Guinness, Harp)



CH-D

### Economy Keg Couplers

Part No.	Description
CH-D	D type
CH-S	S type (Stella Artois, Beck's, Leffe, Czechvar)
CH-G	G type (Bass, Grolsch, Tennent's, Boddington's)
CH-U	U type (Guinness, Harp)
CH-A	A type (Hogaarden, Staropramen)



CH-S



CH-G



CH-U



CH-A

# DRAUGHT BEER DISPENSE SYSTEM COMPONENTS

## KEG COUPLERS

- Complete line of domestic and European keg couplers
- Brass or stainless steel body and probe
- Different types of handles available



CHM-D



CHM-S



CHM-G



CHM-U



CHM-A



CHP137SS



CHP133



CHP172



CHP741

### MicroMatic Keg Couplers

Part No.	Description
CHM-D	D type, MM
CHM-DS	D type, St. Steel, MM
CHM-S	S type, MM (Stella Artois, Beck's, Leffe, Czechvar)
CHM-SS	S type st. steel, MM (Stella Artois, Beck's, Leffe, Czechvar)
CHM-G	G type, MM (Bass, Grolsch, Tennent's, Boddington's)
CHM-U	U type, MM (Guinness, Harp)
CHM-A	A type, MM (Hogaarden, Staropramen)

### Keg Coupler Accessories

Part No.	Description
CHP133	Beer Line Wall Bracket - 3 Way
CHP137SS	Beer Y - Fitting, Stainless Steel
CHP172	Straight Shutoff Valve, Brass
CHP741	Straight Shutoff Valve, Stainless Steel

### Nut & Washer

Part No.	Description
FT1020	Swivel Hex Nut
FT8016	Beer Washer



FT1020



FT8016

# DRAUGHT BEER DISPENSE SYSTEM COMPONENTS

## KEG COUPLER PARTS

- Complete line of keg coupler parts
- Replacement parts for all couplers



### Keg Coupler Parts

Part No.	Description
CHP014	Keg Coupler Part, Handle Assembly, MM
CHP1014	Keg Coupler Part, Safety Relief Valve
CHP218	Keg Coupler Part, Handle Assembly
CHP220	Keg Coupler Part, Ball
CHP221	Keg Coupler Part, Thomas Valve
CHP224	Keg Coupler Part, Probe Assembly D-Type with Ball and Stopper
CHP225	Keg Coupler Part, Probe Assembly S-Type
CHP226	Keg Coupler Part, Hinge Pin S/S
CHP227	Keg Coupler Part, Gas Nipple 3/8"

Part No.	Description
CHP242	Keg Coupler Part, Body Seal
CHP304	Keg Coupler Part, Gas Nipple 5/16"
CHP317	Keg Coupler Part, Probe O-Ring
CHP363	Keg Coupler Part, Hinge Pin S/S, MM
CHP376	Keg Coupler Part, Probe Seal D-Type
CHP383	Keg Coupler Part, Probe S-Type, MM
CHP522	Keg Coupler Part, Probe Seal S-Type
CHP524	Keg Coupler Part, Ball Stop
CHP527	Keg Coupler Part, Ball, MM

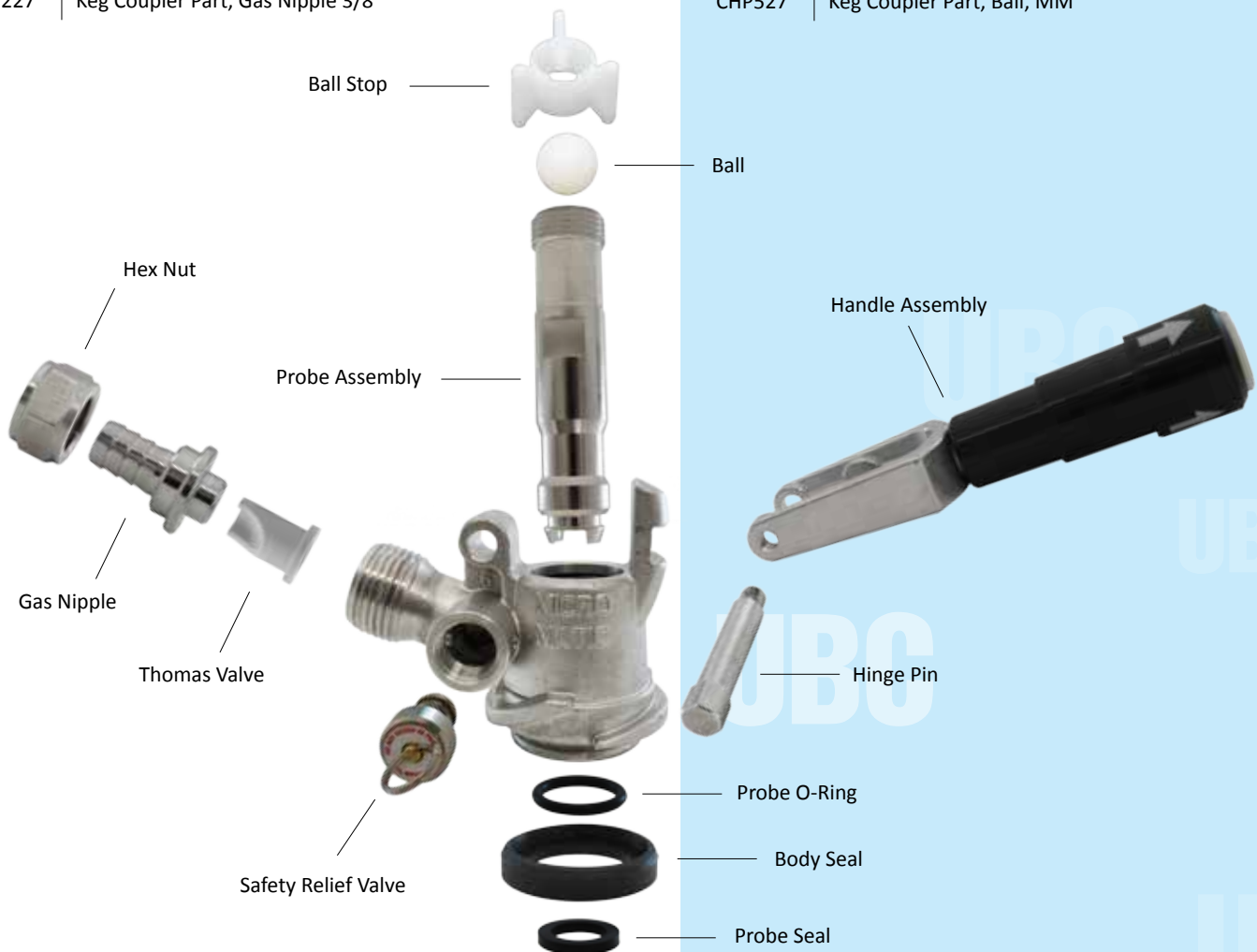

# DRAUGHT BEER DISPENSE SYSTEM COMPONENTS

## DRAUGHT BEER SYSTEM PARTS



- FOB detectors to eliminate foam and wasted beer
- Beer pumps for dispensing draft beer while maintaining the brewers recommended applied pressure on the beer

### FOB Controllers

Part No.	Description
FOB	FOB Detector Ecoflo 3/8"
FOB2	FOB Detector Classic
FOB3	Fob Detector Ecoflo 3/16"
FOBSS	FOB Detector Stainless Steel

### FOB Fittings

Part No.	Description
JGPI251006S	5/16" Stem to 3/16" Hose
JGPI251008S	5/16" Stem to 1/4" Hose
JGPI251208S	3/8" Stem to 1/4" Hose
JGPI251210S	3/8" Stem to 5/16" Hose
JGPI251212S	3/8" Stem to 3/8" Hose
JGPI291208S	3/8" Stem to 1/4" Hose Elbow
JGPM250808S	5/16" Stem to 5/16" Hose
FT9018	1/8" Y fitting with 1/8" End, Plastic
H0-400005	Translucent Poly Tubing, 1/8" ID

### Beer Pumps

Part No.	Description
BPP5000-130	Syrup Pump, FLOJET
PG56	Beer Pump, FLOJET

### Nut & Washer

Part No.	Description
FT1020	Swivel Hex Nut
FT8016	Beer Washer



# DRAUGHT BEER DISPENSE SYSTEM COMPONENTS

## JOHN GUEST FITTINGS

- Complete line of John Guest fittings
- John Guest push-in fittings are fast and reliable connection alternative over traditional compression and barb fittings when connecting two liquid lines



### John Guest Superseals

Part No.	Description
JGSI031012S	5/16" Superseal x 3/8" SpeedFit Union Elbow
JGSI270808S	1/4" Superseal x 1/4" ID Barb
JGSI271008S	5/16" Superseal x 1/4" ID Barb
JGSI271208S	3/8" Superseal x 1/4" ID Barb
JGSI041210S	Superseal Union Connector 3/8" Superseal - 5/16" Speedfit
JGSM040808S	Superseal Union Connector 5/16" Superseal - 5/16" Speedfit



JGSI031012S



JGSI271008S

### John Guest Reducers

Part No.	Description
JGPI201208S	Reducing Union 3/8" - 1/4"
JGPI201210S	Reducing Union 3/8" - 5/16"
JGPI201612S	Union Reducer 1/2" - 3/8"
JGPI211208S	90 Elbow Reducer 3/8" - 1/4"
JGPI211210S	90 Elbow Reducer 3/8" - 5/16"



JGSI271208S



JGPI201612S



JGPI201210S

### John Guest Shut-Offs

Part No.	Description
JGPPSV040808W	Propylene Shut-Off Valve, 1/4"
JGPPSV041212W	Propylene Shut-Off Valve, 3/8"
PF6380390	In-Line Plastic Shut-Off 1/4" x 1/4" Barb
PF6381690	In-Line Plastic Shut-Off 3/8" x 3/8" Barb
PF7108490	In-Line Plastic Shut-Off 5/16" x 5/16" Barb



JGPI211210S



PF6381690



JGPPSV041212W



JGPPSV040808W

# DRAUGHT BEER DISPENSE SYSTEM COMPONENTS

## JOHN GUEST FITTINGS



- Complete line of John Guest fittings
- John Guest push-in fittings are fast and reliable connection alternative over traditional compression and barb fittings when connecting two liquid lines



CPC17004

CPC22004

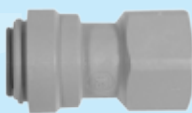

JGPI451213S



JGPI451613S



JGPI121208S

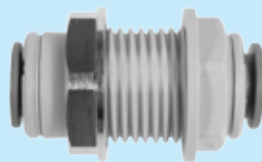

JGPI1212S



JGPI1216S



JGPIC1808R



JGPI0208S



JGPI0216S

### CPC Fittings

Part No.	Description
CPC17004	CPC Quick Disconnect, 1/4" Socket
CPC17006	CPC Quick Disconnect, 3/8" Socket
CPC22004	CPC Quick Disconnect, 1/4" Plug
CPC22006	CPC Quick Disconnect, 3/8" Plug

### John Guest BSPP

Part No.	Description
JGPI011212S	Male Connector 3/8" x 1/4" BSPP
JGPI451213S	Female Connector 3/8" x 3/8" BSPP
JGPI451214FS	Female Connector 3/8" x 1/2" BSPP (Flat End)
JGPI451613S	Female Connector 1/2" x 3/8" BSPP

### John Guest Bulkheads

Part No.	Description
JGPI121208S	Reducing Bulkhead Union 3/8" - 1/4"
JGPI1212S	Bulkhead Union 3/8"
JGPI1216S	Bulkhead Union 1/2"

### John Guest Locking Clips

Part No.	Description
JGPIC1808R	1/4" Locking Clip
JGPIC1812R	3/8" Locking Clip

### John Guest Tees

Part No.	Description
JGPI0208S	Union Tee 1/4"
JGPI0212S	Union Tee 3/8"
JGPI0216S	Union Tee 1/2"



# DRAUGHT BEER DISPENSE SYSTEM COMPONENTS

## JOHN GUEST FITTINGS

- Complete line of John Guest fittings
- John Guest push-in fittings are fast and reliable connection alternative over traditional compression and barb fittings when connecting two liquid lines



### John Guest Stems

Part No.	Description
JGPI131216S	3/8" OD Stem to 1/2" OD Tube Enlarger
JGPI061210S	Reducer 3/8" Stem to 5/16" Tube Grey
JGPI251006S	FOB Fitting, 5/16" Stem to 3/16" Hose
JGPI251008S	FOB Fitting, 5/16" Stem to 1/4" Hose
JGPM250808S	FOB Fitting, 5/16" Stem to 5/16" Hose
JGPI251208S	FOB Fitting, 3/8" Stem to 1/4" Hose
JGPI251210S	FOB Fitting, 3/8" Stem to 5/16" Hose
JGPI251212S	FOB Fitting, 3/8" Stem to 3/8" Hose
JGPI291208S	FOB Fitting, 3/8" Stem to 1/4" Hose Elbow
JGPI251612S	Tube to Hose Stem 1/2" Stem OD - 3/8" Hose ID

### John Guest Dividers

Part No.	Description
JGPI2312S	Two Way Divider 3/8"
JGPI2316S	Two Way Divider 1/2"
JGPI491612S	Three Way Divider 1/2"

### John Guest Connectors

Part No.	Description
JGPI0408S	Union Connector 1/4"
JGPI0412S	Union Connector 3/8"
JGPI0416S	Union Connector 1/2"
JGPM0408S	Union Connector 5/16"



JGPI131216S



JGPI251212S



JGPI251006S



JGPI251008S



JGPI291208S



JGPI251208S



JGPI2312S



JGPI491612S



JGPI0408S



JGPI0412S



JGPI0416S

# DRAUGHT BEER DISPENSE SYSTEM COMPONENTS

## FITTINGS

- Complete line of generic fittings for draught beer systems
- Stainless steel
- Smooth finish



### Elbow Splicers

Part No.	Description
FT9002	1/4" Elbow Hose Splicer
FT9005	3/8" Elbow Hose Splicer
FT9015	1/2" Elbow Hose Splicer
FT4107	5/16" Elbow Hose Splicer



### Y-Fittings

Part No.	Description
FT9051	1/4" Y Fitting with 1/4" End
FT9094	3/8" Y Fitting with 1/4" End
FT9095	3/8" Y Fitting with 3/8" End



### Stepless Clamps

Part No.	Description
FT95	Oetiker Stepless Clamp 09.5
FT105	Oetiker Stepless Clamp 10.5
FT113	Oetiker Stepless Clamp 11.3
FT123	Oetiker Stepless Clamp 12.3
FT133	Oetiker Stepless Clamp 13.3
FT140	Oetiker Stepless Clamp 14.0
FT145	Oetiker Stepless Clamp 14.5
FT157	Oetiker Stepless Clamp 15.7
FT170	Oetiker Stepless Clamp 17.0
FT185	Oetiker Stepless Clamp 18.5
FT210	Oetiker Stepless Clamp 21.0



### Splicers & Reducers

Part No.	Description
FT3220	5/16" x 5/16" Hose Splicer
FT3223	1/4" x 5/16" Hose Splicer
FT9001	1/4" x 1/4" Hose Splicer
FT9012	3/8" x 1/4" Hose Splicer
FT9013	3/8" x 3/8" Hose Splicer
FT9130	1/2" x 1/2" Hose Splicer
FT9138	1/2" x 3/8" Hose Splicer



### T-Fittings

Part No.	Description
FT7008	Barb T Two Stems 3/8" One Stem 1/4"
FT7009	Barb T Two Stems 1/4" One Stem 3/8"
FT7079	Barb T Three Stems 1/2"
FT9006	Barb T 1/4"
FT9007	Barb T 3/8"
FT9009	Barb T Two Stems 1/4" One Stem 3/8"
FT9033	Barb T 5/16"



### Tail Pieces

Part No.	Description
FT3205	1/4" Hose Barb Beer Nut
FT3206	5/16" Hose Barb Beer Nut
FT3207	3/8" Hose Barb Beer Nut
FT3208	1/2" Hose Barb Beer Nut
FT3337	3/16" Hose Barb Beer Nut



# DRAUGHT BEER DISPENSE SYSTEM COMPONENTS

## FITTINGS

- Complete line of generic fittings for draught beer systems
- Stainless steel
- Smooth finish

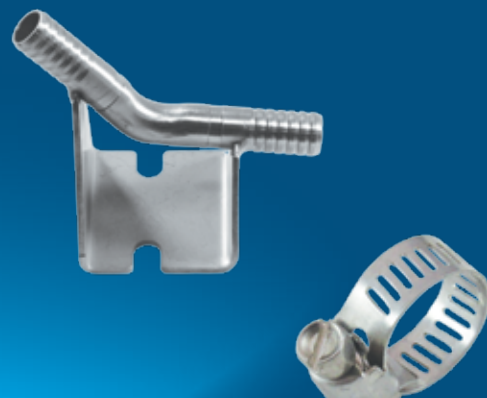

### Cold Plate Fittings

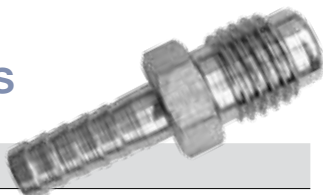

Part No.	Description
FT3016	1/4" Barb Fitting
FT3018	3/8" Barb Fitting
FT7254	3/8" NPT x 1/4" Male Flare Fitting with Red Washer
FT8008	5/16" Flare Washer, Red

### Wall Brackets

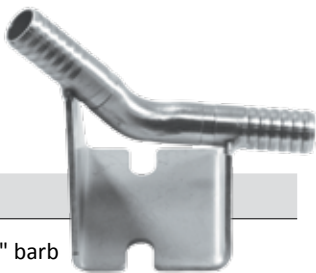

Part No.	Description
FT9401	Wall Bracket with 3/8" barb
FT9403	Wall Bracket with Thread for Beer Nut

### 90° Tail Pieces



Part No.	Description
FT7167	3/16" 90 degree tail piece
FT7176	1/4" 90 degree tail piece
FT7250	3/8" 90 degree tail piece

### Gear Clamps



Part No.	Description
DMHC5-4	5/16"-3/8" SS Gear Clamp
DMHC5-5	1/2" SS Gear Clamp

### Crosses

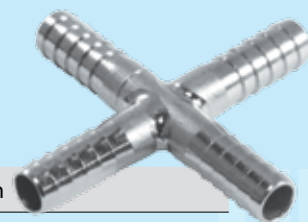

Part No.	Description
FT9010	1/4" Hose Cross
FT9011	3/8" Hose Cross

### U-Bends



Part No.	Description
FT4108	5/16" Hose U-Bend
FT9014	1/4" Hose U-Bend
FT9019	3/8" Hose U-Bend
FT9099	3/8" Hose U-Bend Large Radius

### Hose Plugs

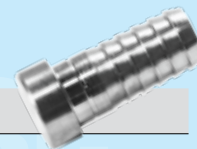

Part No.	Description
FT9027	1/4" Hose Plug
FT9028	3/8" Hose Plug
FT9030	3/8" x 1/2" x 1/4"

### Coil Fittings



Part No.	Description
785F	1/4" Ferrule
785G	1/4" Grommet
786F	5/16" Ferrule
786G	5/16" Grommet
787F	3/8" Ferrule
787G	3/8" Grommet

# DRAUGHT BEER DISPENSE SYSTEM COMPONENTS

## TRUNKLINE

- New ultra-smooth bore tube for ultimate in beverage tube performance
- Low adhesion of bacteria and yeast
- Reduced formation of “beer stone” to extend cleaning cycle
- Color coded beer lines for easier installation

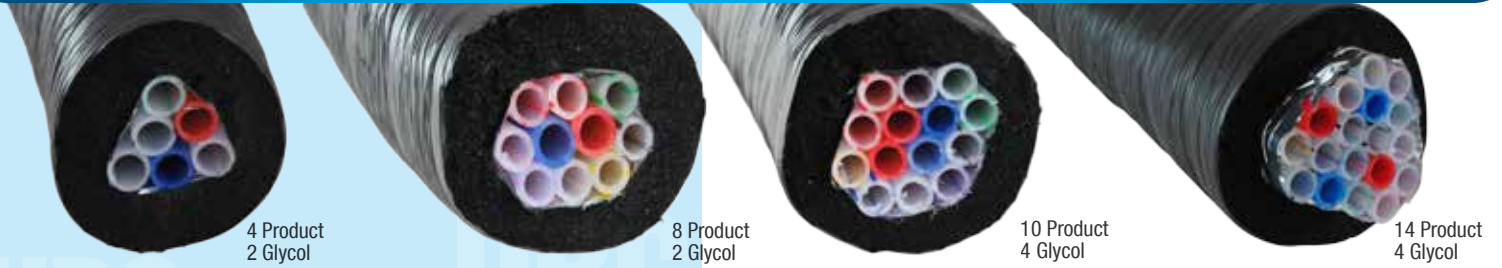

4 Product  
2 Glycol

8 Product  
2 Glycol

10 Product  
4 Glycol

14 Product  
4 Glycol

### 1/4" I.D. Trunk Line

Part No.	Description
TRT1439	10 Product/4 Glycol

### 3/8" I.D. Trunk Line

Part No.	Description
TRT1446	4 Product/2 Glycol
TRT1447	6 Product/2 Glycol
TRT1448	8 Product/2 Glycol
TRT1449	10 Product/4 Glycol
TRT1461	12 Product/4 Glycol
TRT1462	14 Product/4 Glycol

### 5/16" I.D. Trunk Line

Part No.	Description
TRT1441	4 Product/2 Glycol
TRT1442	6 Product/2 Glycol
TRT1443	8 Product/2 Glycol
TRT1444	10 Product/4 Glycol
TRT1489	12 Product/4 Glycol
TRT1490	14 Product/4 Glycol

## Product Highlights

#### Fire Rating

Flame retardant, Class 1

#### Foil Wrap

Efficient cold transfer from glycol lines to beer lines

#### Color Coded Beer Lines

5/16" or 3/8" I.D.

#### Moisture Barrier Wrap

Prevent condensation inside trunk line

#### Insulation

3/4"

#### Color Coded Glycol Lines

3/8" I.D.



# DRAUGHT BEER DISPENSE SYSTEM COMPONENTS

## TUBING & ACCESSORIES

- New ultra-smooth bore tube for ultimate in beverage tube performance
- Low adhesion of bacteria and yeast
- Reduced formation of “beer stone” to extend cleaning cycle
- Color coded beer lines for easier installation

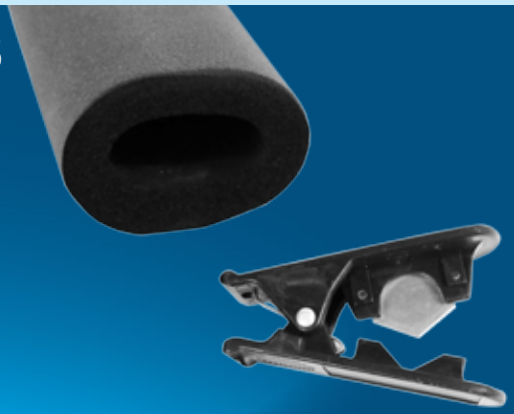

### Insulation Tube

Part No.	Description
IT11812	1 1/8" ID Insulation Tube, 1/2" Wall Thickness, 6' Long
IT11834	1 1/8" ID Insulation Tube, 3/4" Wall Thickness, 6' Long
IT13812	1 3/8" ID Insulation Tube, 1/2" Wall Thickness, 6' Long
IT13834	1 3/8" ID Insulation Tube, 3/4" Wall Thickness, 6' Long
IT5812	1 5/8" ID Insulation Tube, 1/2" Wall Thickness, 6' Long
IT5834	1 5/8" ID Insulation Tube, 3/4" Wall Thickness, 6' Long
IT21812	2 1/8" ID Insulation Tube, 1/2" Wall Thickness, 6' Long
IT21834	2 1/8" ID Insulation Tube, 3/4" Wall Thickness, 6' Long

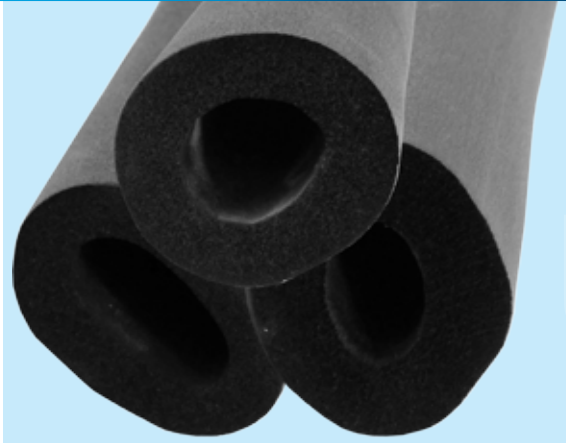

### Tape

Part No.	Description
BT2	2" PVC Barrier
CT2	2" Cork
FIT2	2" Foam Insulation
FT2	2" Foil



BT2



CT2



FIT2

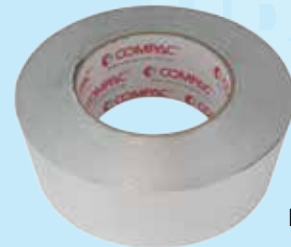

FT2

### Accessories

Part No.	Description
TL952	Hose Cutter Blade
TL958	Hose Cutter
TL954	Trunkline Cutter



TL954

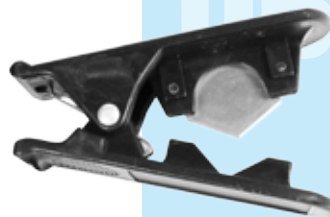

TL958

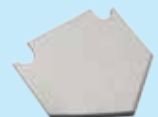

TL952

# DRAUGHT BEER DISPENSE SYSTEM COMPONENTS

## TUBING

- New ultra-smooth bore tube for ultimate in beverage tube performance
- Low adhesion of bacteria and yeast
- Reduced formation of “beer stone” to extend cleaning cycle
- Color coded beer lines for easier installation

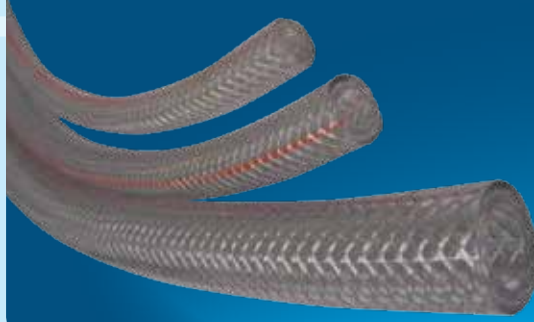

Thermoplastic Vinyl Hose

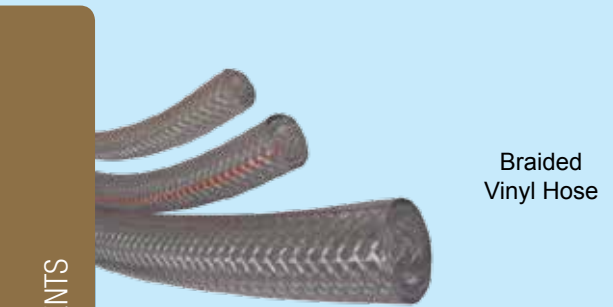

Braided Vinyl Hose



Polyethylene Hose



Bev-Seal Tubing

## Thermoplastic Vinyl Hose

Part No.	Description	ID	OD	Clamp size
HO200-0307	100' Coil, Clear PVC Tubing	3/16"	7/16"	12.3
HO200-0408	100' Coil, Clear PVC Tubing	1/4"	1/2"	14.0
HO200-0509	100' Coil, Clear PVC Tubing	5/16"	9/16"	15.7
HO200-0610	100' Coil, Clear PVC Tubing	3/8"	5/8"	17.0
HO204-0509	100' Coil, Red PVC Tubing for Air Supply	5/16"	9/16"	15.7
HO204-0610	100' Coil, Red PVC Tubing for Air Supply	3/8"	17/32"	17.0

## Braided Vinyl Hose

Part No.	Description	ID	OD	Clamp size
HOK3150-03	100' Coil, Clear Braided Tubing	3/16"	3/8"	11.3
HOK3150-04	100' Coil, Clear Braided Tubing	1/4"	7/16"	12.3
HOK3150-05	100' Coil, Clear Braided Tubing	5/16"	17/32"	14.0
HOK3150-06	100' Coil, Clear Braided Tubing	3/8"	19/32"	17.0
HOK3150-08	100' Coil, Clear Braided Tubing	1/2"	3/4"	21.0

## Polyethylene Hose

Part No.	Description	ID	OD	Clamp size
HO222-0662	100' Coil, Translucent Poly Tubing	1/4"	3/8"	10.5
HO222-0862	100' Coil, Translucent Poly Tubing	3/8"	1/2"	13.3

## Bev-Seal Ultra Beverage Tubing

Part No.	Description	ID	OD	Clamp size
HO228-0762	Bev-Seal Ultra Beverage Tubing, 5/16" ID	5/16"	7/16"	12.3
HO235-0662	Bev-Seal Ultra Beverage Tubing, 1/4" ID	1/4"	3/8"	11.3
HO235-0862	Bev-Seal Ultra Beverage Tubing, 3/8" ID	3/8"	1/2"	13.3



# KEGERATORS

## Kegerators

- Variety of direct draw kegerators from single door to triple door units
- Heavy duty construction
- Stainless steel interior and counter top

■ <b>Large Kegerators</b> .....	88
■ <b>KegBar BB-100</b> .....	89
■ <b>Kegmaster 2</b> .....	90
■ <b>Kegerator Accessories</b> .....	91

# KEGERATORS

## LARGE KEGERATORS

- Direct draw draught beer coolers



ADD-58



ADD-68

	ADD-58	ADD-68	ADD-94
Net Capacity (Cu. ft.)	20.82	25.49	37.65
Width, Overall (in.)	59 1/2"	69 1/2"	95 1/2"
Depth, Overall (in.)	28"		
Height, Overall (in.) (Not including 12" Towers)	37"		
Number of Doors	2		3
Condensing Unit Size (H.P.)	1/3		
Refrigerant	R-134A		
Cabinet Electrical Specs	115/60		
Total Amps	6.6		7.2
Power Supply Cord (10 ft.)	YES		
Shipping Weight (lbs.)	343	370	429
Shipping Height (in.)	62.5"	31.5"	43"
Shipping Length (in.)	72.5"	31.5"	43"
Shipping Depth (in.)	98"	31.5"	43"
Keg Configurations	<p><b>Config 1.</b> 2 x 50L Kegs 1 x 30L Keg</p> <p><b>Config 2.</b> 1 x 50L Keg 1 x 30L Keg 3 x 20L Kegs</p> <p><b>Config 3.</b> 6 x 30L Kegs</p> <p><b>Config 4.</b> 8 x 20L Kegs</p>	<p><b>Config 1.</b> 3 x 50L Kegs</p> <p><b>Config 2.</b> 1 x 50L Keg 2 x 30L Kegs 4 x 20L Kegs</p> <p><b>Config 3.</b> 8 x 30L Kegs</p> <p><b>Config 4.</b> 12 x 20L Kegs</p>	<p><b>Config 1.</b> 5 x 50L Kegs</p> <p><b>Config 2.</b> 1 x 50L Keg 4 x 30L Kegs 7 x 20L Kegs</p> <p><b>Config 3.</b> 12 x 30L Kegs</p> <p><b>Config 4.</b> 17 x 20L Kegs</p>

\*NOTE: A minimum clearance of 3" on each side, front and rear of cabinet is required for optimum performance.



# KEGERATORS

## KEGBAR BB-100

- New innovative design featuring front ventilation
- Designed to be installed in a tight space
- Stainless steel interior and counter top
- Cassette type cooling unit for easy service

### Kegbar BB-100

KEGBAR BB-100	
Size without packaging HxDxW	39x28x33 in
Capacity	1/2 barrel - 1 keg 1/4 barrel - 2 kegs 1/6 barrel - 4 kegs
Tower	American 3" or Gefest Stainless Steel
Height with tower (American/Gefest)	52/58 in
Noise	Not more than 65 db
Forced interior air circulation	Yes
Operating amperage	5.3 A
Dedicated circuit	15 A
Thermostat model	Digital
Compressor capacity	1/4+ hp (944 Wt)
Refrigerant type	R134-a
Wall thickness	1.7 in
Interior material	Stainless Steel
Door lock	Yes
Wheels	Yes
Weight Net/Gross	212 lbs / 225 lbs
Branding	Available as an option



KEGBAR BB-100



# KEGERATORS

## KEGMASTER 2

- New more compact construction
- Cooling units slides out for easy service
- Stainless steel interior and counter top
- Beer tower is cooled by forced air



KEGMASTER 2

### Kegmaster 2

KEGMASTER 2	
Size without packaging HxDxW	39x31x24 in
Capacity	1/2 Barrel - 1 Keg 1/4 Barrel - 2 Kegs 1/6 Barrel - 4 Kegs
Tower	American 3" Cylinder, Gefest, Terra
Height with tower (American/Gefest)	52/58 in
Noise	Not more than 65 db
Forced interior air circulation	Yes
Operating amperage	3.7 A
Dedicated circuit	15 A
Thermostat model	Manual
Compressor capacity	1/5 HP
Refrigerant type	R134-A
Wall thickness	1.7 in
Interior material	Stainless Steel
Door lock	Yes
Wheels	Yes
Weight Net/Gross	150 lbs / 160 lbs
Branding	Available as an option



Branding available as an option

# KEGERATORS

## KEGERATOR ACCESSORIES

- Suggested Kegerator Towers
- Kegerator Kits
- Kegerator Tools
- Kegerator Accessories
- CO2 Tank



### Gefest Tower

Name	Part No.	Faucets
Gefest 1, Air	GFA152-1	1
Gefest 2, Air	GFA152-2	2

### Terra Tower

Name	Part No.	Faucets
Terra 2	TR188-2	2
Terra 3	TR224-3	3

### Cylinder Tower

Name	Part No.	Faucets
3" Cylinder 1, Chrome, AIR	D4743T	1
3" Cylinder 1, Chrome, AIR	D4743DT	2
3" Cylinder 1, Chrome, AIR	D4743TT	3

### Silva Tower

Name	Part No.	Faucets
Silva, Ceramic 1	CTSL1	1
Silva, Ceramic 2	CTSL2	2
Silva, Ceramic 3	CTSL3	3

### Indie Tower

Name	Part No.	Faucets
Indie	IND1	1

### Beer Line Cleaning Kits

Part No.	Description
LCK-1	Direct Draw System, 1 Qt
LCK-D	Direct Draw System, 1.3 Gallon

### Kegerator Branding

Name	Part No.
Door Branding	BRANDING-KG-Door
Door & Sides Branding	BRANDING-KG-Full

### CO2 Tanks

Name	Part No.
CO2 Tank, 5 lbs	CO2-5

Our 5 lb aluminum alloy CO2 cylinders are certified and stamped for use in the USA (US DOT 3AL) and also Canada (TC-3ALM).



### Kegerator Tapping Kits (CO2)

Part No.	Faucets	Includes
KK1-ASM	1	Primary CO2 Regulator, Keg Coupler - D Type, Hosing, Clamps
KK2-ASM	2	Primary CO2 Regulator, Keg Couplers - D Type (2), Air Distributor, Hosing, Clamps
KK3-ASM	3	Primary CO2 Regulator, Keg Couplers - D Type (3), Air Distributor, Hosing, Clamps
KK4-ASM	4	Primary CO2 Regulator, Keg Couplers - D Type (4), Air Distributor, Hosing, Clamps

# REACH-IN REFRIGERATORS



## Reach-in Refrigerators

- Large glass surface for increased visibility
- Extra large interior usable space
- Highest climate class - class 4 (outdoor use)
- Branded exterior walls (optional)
- Galvanized steel case primed on both sides and painted on the outer side for increased durability and anti-corrosion

■ <b>Smart Cool 350</b> .....	93
■ <b>IceStream OPTIMA</b> .....	94
■ <b>IceStream SUPER LARGE</b> .....	95

# REACH-IN REFRIGERATORS

## Smart Cool 350

- Heavy-duty construction
- Energy efficient door frames
- Embraco 1/6 hp compressor
- Digital thermostat
- Forced air Ribbed pipe evaporator
- Illuminated lightbox with a logoed screen

## IceStream Smart Cool

Size without packaging HxDxW	81x23x23 in
Int. volume	12.4 cu ft
Noise	Not more than 55 db
Interior lighting	Philips, DeLux, Osram
Forced interior air circulation	Yes
Evaporator type	Static cooling, alluminium roll-bond
Forced condenser cooling	No
Operating amperage	2.6 A
Thermostat model	Dixell XR02CX
Compressor type	Embraco EMT6144U
Compressor capacity	1/6 hp (270 Wt)
Wall thickness	1.5 in
Interior material	Metal
Interior steel gauge	0.5 mm
Qty of shelves	4
Door lock	Yes
Wheels	Yes
Weight (Net)	187 lbs (85 kg)



Branding available as an option

# REACH-IN REFRIGERATORS

## IceStream OPTIMA

- Heavy-duty design
- 3/8 hp Embraco compressor
- Large interior usable space
- Vertical built-in lighting for better product visibility
- Door lock
- Custom branding available on request



## IceStream Optima

Size without packaging HxDxW	81x30x29.5 in
Int. volume	26 cu ft
Noise	Not more than 65 db
Interior lighting	Philips, DeLux, Osram
Forced interior air circulation	Yes
Evaporator type	Dynamic cooling, ribbed pipe
Forced condenser cooling	Yes
Operating amperage	4 A
Thermostat model	AKO 13120 / Dixell XR02CX
Compressor type	Embraco NE6210Z
Compressor capacity	3/8 hp (520 Wt)
Refrigerant type	R-134a
Wall thickness	2.3 in, foam filled
Interior material	Metal
Interior steel gauge	0.5 mm
Qty of shelves	5
Door lock	Yes
Wheels	Rear wheels, front adjustable legs
Weight (Net)	313 lbs (142 kg)

Branding available as an option



## REACH-IN REFRIGERATORS

# IceStream SUPER LARGE

- Heavy-duty design
- 1/2 hp Tecumseh compressor
- Vertical built-in lighting for better product visibility
- Sliding doors with a lock
- Large interior usable space
- Custom branding available on request

## IceStream Super Large

Size without packaging HxDxW	81x29x51 in
Int. volume	42.4 cu ft
Noise	Not more than 65 db
Interior lighting	Philips, DeLux, Osram
Forced interior air circulation	Yes
Evaporator type	Dynamic cooling, ribbed pipe
Forced condenser cooling	Yes
Operating amperage	4.4 A
Thermostat model	AKO 13120 / Dixell XR02CX
Compressor type	Tecumseh CAJ4461Y
Compressor capacity	1/2 hp (900 Wt)
Wall thickness	2.3 in
Interior material	Metal
Interior steel gauge	0.5 mm
Qty of shelves	10
Door lock	Yes
Wheels	Yes
Weight (Net)	485 lbs (220 kg)



Branding available as an option

# BACK BAR COOLERS



## Back Bar Coolers

- Single door to triple door back bar refrigerators
- Front ventilation and cassette type cooling unit for easy service

■ <b>CoolBar BB-100</b> .....	97
■ <b>Large Back Bar Coolers</b> .....	98



# BACK BAR COOLERS

## COOLBAR BB100

- All stainless steel top and interior
- Front ventilation
- Energy efficient, “Low-E”, double pane thermal insulated glass door
- Heavy duty PVC coated wire shelves



### CoolBar BB-100

COOLBAR BB-100	
Size Without Packaging HxDxW	39x28x33 in
Internal Volume	8.2 cu ft
Capacity	315 Bottles (0.33L)
Noise	Not more than 65 db
Interior Lighting	LED
Forced Interior Air Circulation	Yes
Evaporator Type	Dynamic Cooling, Ribbed Pipe
Forced Condenser Cooling	Yes
Operating Amperage	5.3 A
Dedicated Circuit	15 A
Thermostat Model	Digital
Compressor Capacity	1/4+ hp (944 Wt)
Refrigerant Type	R134-a
Wall Thickness	1.7 in
Interior Material	Stainless Steel
Quantity of Shelves	3
Door Lock	Yes
Wheels	Yes
Weight Net/Gross	212 lbs / 225 lbs
Branding	Available as an Option



Sliding refrigeration module  
for easier servicing

## BACK BAR COOLERS

# LARGE BACK BAR COOLERS

- Heavy-duty design
- Enhanced refrigeration system
- Left side mount compressor and front breathing
- Analog thermostat
- Adjustable coated wire shelves
- Solid and glass door options



ABBC-58



ABBC-68



Glass doors available upon request

	2 DOOR COOLER	2 DOOR LARGE COOLER
Part Number	ABBC-58	ABB-68
Doors	2	
Capacity (12 Oz Can)	852	1,014
Shelves	4	
Total Amps	6.6	
HP	1/3	
Voltage	115/60/1	
Nema Plug	5-15P	
Cord Length	8'	
Length (in.)	59 1/2"	69 1/2"
Depth (in.)	28"	
Height (in.)	37"	
Shipping Weight	343 lbs.	370 lbs.

\*NOTE: A minimum clearance of 3" on each side, front and rear of cabinet is required for optimum performance.

## BACK BAR COOLERS

# LARGE BACK BAR COOLERS

- Heavy-duty design
- Enhanced refrigeration system
- Left side mount compressor and front breathing
- Analog thermostat
- Adjustable coated wire shelves
- Solid and glass door options



	3 DOOR COOLER
Part Number	ABBC-94
Doors	3
Capacity (12 Oz Can)	1,302
Shelves	6
Total Amps	7.2
HP	1/3
Voltage	115/60/1
Nema Plug	5-15P
Cord Length	8'
Length (in.)	95 1/2"
Depth (in.)	28"
Height (in.)	37"
Shipping Weight	429 lbs.

Glass doors available upon request

\*NOTE: A minimum clearance of 3" on each side, front and rear of cabinet is required for optimum performance.

## Shelf Dividers

Part No.	Description
VS12-10	Merchandising Glide Rack VISI Slide, 12oz, 10 Rows Wide
VS12-10	Merchandising Glide Rack VISI Slide, 16oz, 10 Rows Wide

# MOBILE AND EVENT BEER COOLING & DISPENSING



## Mobile and Event Beer Cooling & Dispensing

- A great way to keep the beer flowing where built-in systems can not be used
- Cold keg beer anywhere, anytime without using electricity
- All you need is ice for cooling beer and CO<sub>2</sub> for dispensing
- Can be used for dispensing other beverages - soda water, bag-in-box juices or wine

■ <b>Mobile Dispense Parts</b> .....	101
■ <b>Jockey Box Picnic Coolers</b> .....	102

# MOBILE AND EVENT BEER COOLING & DISPENSING

## MOBILE DISPENSE PARTS

- Reliable parts to make your event a success
- Can be used outdoor
- Commercial grade parts for home use
- Parts to use when creating your own patio beer dispenser



KP008



KP008F



KP501



JBA402000



JBA401000



JBA404000



JBA50



JBA70



JBA120

## High Efficiency Product Coils

Part No.	Coil O.D.	Coil Length	Height	Width	Depth
JBA50	5/16"	50'	5 1/2"	5 1/4"	7 1/2"
JBA70	5/16"	70'	6 1/2"	9"	9"
JBA120	3/8" - 1/4"	120'	9"	9 1/2"	9 1/2"

## Party Pumps

Part No.	Description
KP008	Keg Pump, 8"
KP008F	Keg Pump with faucet, 8"
KP501	Pony Keg Pump

## Cold Plates

Part No.	Description
JBA0812-1	Cold Plate 8"x12", 1 product, 1/4" barb
JBA0812-2	Cold Plate 8"x12", 2 products, 1/4" barb
JBA1015-2	Cold Plate 10"x15", 2 products, 1/4" barb
JBA0814-3	Cold Plate 8"x14", 3 products, 1/4" barb
JBA0814-8	Cold Plate 8"x14", 8 products, 1/4" barb

## Cold Plate Fittings

Part No.	Description
FT3016	1/4" Barb Fitting
FT3018	3/8" Barb Fitting
FT7254	3/8" NPT x 1/4" Male Flare Fitting with Red Washer
FT8008	5/16" Flare Washer, Red

## CO2 Tanks

Name	Part No.
CO2 Tank, 5 lbs	CO2-5



**NEW  
ARRIVAL**

# MOBILE AND EVENT BEER COOLING & DISPENSING JOCKEY BOX PICNIC COOLERS

- 304 stainless steel coil
- Square coils for a better fit in the cooler.
- Coils stand on legs to allow ice-cold water to chill beer from underneath.



## Jockey Boxes with Coils

Part No.	Faucets	Finishing	Coil Length	Coil O.D.	W <sup>id</sup> th	H <sup>ei</sup> ght	D <sup>e</sup> pth
JB50-1	1	Plastic	50'	5/16"	11 1/2"	11"	8 1/2"
JB70-1	1	Plastic	70'	5/16"	20 3/16"	10 5/8"	9 3/4"
JB70SS-1	1	Stainless Steel	70'	5/16"	24"	16 1/2"	15"
JB120-1	1	Plastic	120'	3/8" - 1/4"	20 3/16"	10 5/8"	9 3/4"
JB120SS-1	1	Stainless Steel	120'	3/8" - 1/4"	24"	16 1/2"	15"
JB70-2	2	Plastic	2 x 70'	5/16"	20 3/16"	10 5/8"	9 3/4"
JB70SS-2	2	Stainless Steel	2 x 70'	5/16"	24"	16 1/2"	15"
JB120-2	2	Plastic	2 x 120'	3/8" - 1/4"	20 3/16"	10 5/8"	9 3/4"
JB120SS-2	2	Stainless Steel	2 x 120'	3/8" - 1/4"	24"	16 1/2"	15"
JB50-3	3	Plastic	3 x 50'	5/16"	20 3/16"	10 5/8"	9 3/4"
JB50SS-3	3	Stainless Steel	3 x 50'	5/16"	24"	16 1/2"	15"
JB120-3	3	Plastic	3 x 120'	3/8" - 1/4"	33"	17"	15"
JB50-4	4	Plastic	4 x 50'	5/16"	20 3/16"	10 5/8"	9 3/4"
JB50SS-4	4	Stainless Steel	4 x 50'	5/16"	24"	16 1/2"	15"
JB50-5	5	Plastic	50'	5/16"	20 3/16"	10 5/8"	9 3/4"



Branded Jockey Boxes on Page 121



MOBILE AND EVENT BEER COOLING & DISPENSING

# MOBILE AND EVENT BEER COOLING & DISPENSING JOCKEY BOX PICNIC COOLERS

**NEW  
ARRIVAL**

- 304 stainless steel coil
- Square coils for a better fit in the cooler.
- Coils stand on legs to allow ice-cold water to chill beer from underneath.

## Jockey Boxes with Towers

Part No.	Faucets	Finishing	Coil Length	Width	Height	Depth
JB70SS-2T	2	Stainless Steel	70'	24"	28 1/2"	15"
JB316SS-3 (wine)	3	Stainless Steel	70'	24"	28 1/2"	15"

## Jockey Box Tapping Kits (CO2)

Part No.	Faucets	Includes
JBK1-ASM	1	Primary CO2 Regulator, Keg Coupler - D Type, Hosing, Fittings
JBK2-ASM	2	Primary CO2 Regulator, Keg Coupler - D Type (2), Hosing, Fittings
JBK3-ASM	3	Primary CO2 Regulator, Keg Coupler - D Type (3), Hosings Fittings
JBK3W-ASM (wine)	3	Primary Nitrogen Regulator, Hosing, Fittings



## Jockey Box DIY Assembly Kits

Part No.	Coil Length	Includes
JBAK50-1	50'	Coil, Shank Assembly, Faucet, Hosing, Fittings, etc.
JBAK70-1	70'	Coil, Shank Assembly, Faucet, Hosing, Fittings, etc.
JBAK120-1	120'	Coil, Shank Assembly, Faucet, Hosing, Fittings, etc.

### JBAK50-1

- Super Coil, 50' Stainless Steel Coil
- 2 x John Guest Fittings
- Cooler Coupling / Shank Washer
- Cooler Coupling 3" Assembly, 5/16" Bore
- Shank Assembly with Nipple, 2 1/2" with 3/16" Bore, 3/16" Nipple
- Domestic Faucet, Chrome Plated, Brass Lever
- 2 x Beer Washers
- 2 x Swivel Hex Nuts
- 2 x Fitting, Tail Piece, 3/8" Hose Barb for Beer Nut
- 3 x Oetiker Stepless Clamps, 17.0
- 2 x Oetiker Stepless Clamps, 13.3
- Thermoplastic Vinyl Hose, Clear PBV Tubing, 3/8" ID
- Thermoplastic Vinyl Hose, Clear PBV Tubing, 3/16" ID



MOBILE AND EVENT BEER COOLING & DISPENSING

# INSTALLATION AND MAINTENANCE TOOLS



## Installation and Maintenance Tools

- Generic tools for installation and maintenance of draught beer systems
- Solutions and tools for professional beer line cleaning

■ <b>Tools &amp; Accessories</b> .....	105
■ <b>Beer Line Cleaning Equipment</b> .....	106



# INSTALLATION AND MAINTENANCE TOOLS

## TOOLS & ACCESSORIES

- Generic tools for installation and maintenance of draught beer systems



BPB12CFM

### Thermostats

Part No.	Description
TRK-1C1	Digital Thermostat ETC
TRK-50R	Manual Thermostat Ranco K50
TRK-52A	Digital Thermostat AKO
TRK-53D	Digital Thermostat Dixell
ST-01	Spirit thermometer



TRK-50R



TRK-52A

### Faucet Accessories

Part No.	Description
TL107	Draft Arm Wrench
TL187	Faucet Wrench
TL123	Faucet & Hex Nut Wrench
TL271	Faucet Cleaning Brush
TL237	Double Sided Faucet Brush

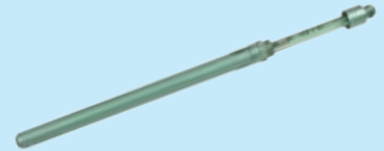

ST-01



TRK-53D



TL123

### Other Accessories

Part No.	Description
TL260	CO2 Wrench - Off Set
TL261	CO2 Wrench - Standard
TL200	Spanner Brass Chrome
TL100	Clamp Crimper Standard
TL202	Tube Sizing Rod
TL2701-BCT	Beer Carbonation Tester with Protective Case
BPB12CFM	Blower System Part, 12 CFM
BPB12	Hanger Bracket for 12 CFM Blower with Hose Port



TL270-BCT



TL187



TL100



BPB12



TL260

### Propylene Glycol

Part No.	Description
GL-1G	1 Gallon
GL-5G	5 Gallons



GL-1G



TL-200



TL261



TL271



TL237

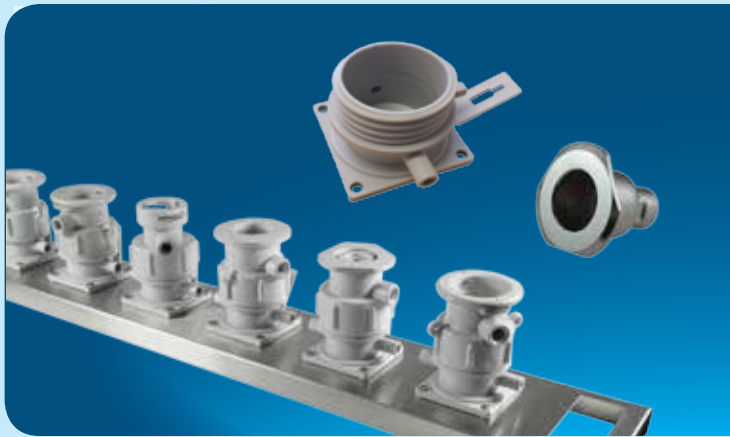

# INSTALLATION AND MAINTENANCE TOOLS BEER LINE CLEANING EQUIPMENT

■ Solutions and tools for professional beer line cleaning

## Beer Line Cleaning Kits

Part No.	Description
LCK-1	Direct Draw System, 1 Qt Cleaning Kit
LCK-D	Direct Draw System, 1.3 Gallon Cleaning Kit, D Valve

## Cleaning Accessories and Parts

Part No.	Description
LCP100	Manual Relief Valve for Cleaning Tanks
LCP103	Back Plate
LCP104	Plastic Series Flasher, No Ball Lifter
LCP108	Single Flusher for Single Hole Keg Valve Taps
LCP109	SS Series Flusher with Ball Lifter
LCP110	Double Flusher for Single Hole Keg Valve Taps
LCP1301	Single Flusher - G
LCP2A1	Single Flusher - A
LCP4353	Straight Cleaning Attachment with 5/16" Hose Barb End (2 pc.)
LCP801	End Stop Cap - In Place Cleaning Caps
LCP851	Ball Lifter for cleaning from the faucet through the coupler
LCP901	Stainless Steel Mounting Board with Handle
LCP902	Duplex Coupling Connects 2 Beer Lines for Simultaneous Cleaning
LCP934	4 oz. tube lubricant
LCP938	8 oz. tin of probe lubricant

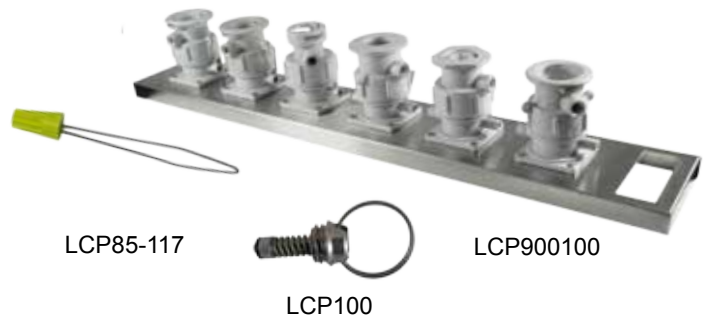

# INSTALLATION AND MAINTENANCE TOOLS

## BEER LINE CLEANING EQUIPMENT

- Solutions and tools for professional beer line cleaning



### Cleaning Valves

Part No.	Description
LCF001A	A System Valve: Warsteiner, Paulaner, Spaten
LCF002G	G System Valve: Bass, Anchor Steam, Boddington
LCF003S	S System Valve: Heineken, Beck's, Scottish & Newcastle
LCF005D	D System Valve: Anheuser-Busch, Coors, Miller, Yuengling
LCF006U	U System Valve: Guinness, Harp
LCF007M	M System Valve: Schneider, Aventinus, Einbecker



LCF001A



LCF002G



LCF003S

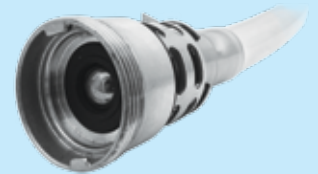

LCF005D



LCF006U

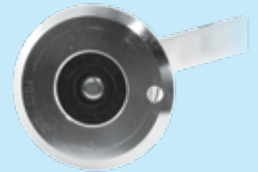

LCF007M

### Cleaning Cans

Part No.	Description
LCT1455	1.3 Gallon Plastic Cleaning Can with one head*
LCT312-CH	2.4 Gallon Stainless Steel Cleaning Can with two heads, Economy*
LCT312	2.4 Gallon Stainless Steel Cleaning Can with two heads*
LCT320	2.4 Gallon Stainless Steel Cleaning Can with four heads*
LCT412-CH	4 Gallon Stainless Steel Cleaning Can with two heads, Economy*
LCT412	4.8 Gallon Stainless Steel Cleaning Can with two heads*
LCT420	4.8 Gallon Stainless Steel Cleaning Can with four heads*

\*Cleaning valves sold separately



LCT420

LCT312



LCT412-CH

LCT312-CH



LCT1455

# INSTALLATION AND MAINTENANCE TOOLS

## BEER LINE CLEANING EQUIPMENT

■ Solutions and tools for professional beer line cleaning



LCF801147

LCF808033

LCF808041



LCF808051

LCF808053



LCF802912KS

LCF802064KS

LCF801184KS



LCF801180KS

LCF801174KS



LC31002

LC31004

LC31005



LC31032

LC32011

LC32013

## Cleaning Caps

Part No.	Description
LCF801147	D type cleaning plastic cap
LCF808033	S type cleaning plastic cap
LCF808041	U type cleaning plastic cap
LCF808051	G type cleaning plastic cap
LCF808053	A type cleaning plastic cap
LCF802912KS	D type cleaning panel plastic cap
LCF802064KS	A type cleaning panel plastic cap
LCF801184KS	S type cleaning panel plastic cap
LCF801180KS	G type cleaning panel plastic cap
LCF801174KS	U type cleaning panel plastic cap
LC110000S	5L. Dip Tube

## Beer Line Cleaners

Part No.	Description
LC31002	32 oz beverage system cleaner, BLC
LC31004	1.9 oz beverage system cleaner, TM DESANAMAX
LC31005	1 gal beverage system, TM DESANAMAX
LC31032	32 oz beverage system cleaner, PENETRATE
LC32011	16 oz beverage system cleaner, SUPER NO-RINSE
LC32013	40 lb beverage system cleaner, SUPER NO-RINSE
LC32021	32 oz beverage system cleaner, PLC
LC4933B	1 gal beverage system cleaner, BENEFIT
LC5100	Sanitap Drain Cleaner Strips 5", 10 per package
LC5102	Sanitap Drain Cleaner Strips 12", 10 per package
LC5106	Sanitap Floor Drain Cleaner, 16", 3 per package



LC32021



LC5100/LC5102



LC5106



## Brewery Targeted Products

■ <b>Cylinder Branded Towers</b> .....	110
■ <b>Kegs</b> .....	111
■ <b>PEGAS CraftTap</b> .....	112
■ <b>PEGAS CraftPad</b> .....	113
■ <b>PEGAS CraftPad Light</b> .....	114
■ <b>Growler Filling Station</b> .....	115
■ <b>Growler Washing Station</b> .....	116
■ <b>PEGAS Evolution Faucet</b> .....	117
■ <b>Craft Beer Dispensing Station</b> .....	118
■ <b>Ceramic Tap Handles</b> .....	119
■ <b>Illuminated Pub Signs</b> .....	120
■ <b>Jockey Boxes</b> .....	121
■ <b>Patio Umbrellas / Chalkboards</b> .....	122
■ <b>Tables</b> .....	123

# BRWEERY TARGETED PRODUCTS

**NEW  
ARRIVAL**

# BREWERY TARGETED PRODUCTS CYLINDER BRANDED TOWERS

- Ideal for special events
- 304 Stainless Steel body
- Optional Glycol or Air cooling
- 3/8" Copper Glycol recirculation lines

## Cylinder

Name	Part No.	<b>F</b> aucets	<b>H</b> eight
3" Cylinder 1, Chrome, AIR	D4743T	1	12"
3" Cylinder 1, Chrome, GLYCOL	D4743TG	1	12"
3" Cylinder 2, Chrome, AIR	D4743DT	2	12"
3" Cylinder 2, Chrome, GLYCOL	D4743DTG	2	12"
3" Cylinder 2, Chrome, GLYCOL LED	D4743DTG-LED	2	12"
3" Cylinder 3, Chrome, AIR	D4743TT	3	14"
3" Cylinder 3, Chrome, GLYCOL	D4743TTG	3	14"

Available with LED medallions



## BREWERY TARGETED PRODUCTS

# KEGS

- 304 Stainless Steel kegs
- Generic or Micromatic spears
- Stackable or non-stackable
- Available embossed and branded

YOUR BREWERY



## Kegs

- Available in 5L, 10L, 20L, 30L, 50L, 58L
- Meeting the highest keg standards
- AISI 304 stainless steel
- Generic or Micromatic Spears
- Serial numbers on time chime
- Optional brand embossing
- Stackable or non-stackable



Full line of Keg  
Accessories on Page 66.



## BREWERY TARGETED PRODUCTS

# PEGAS CRAFTAP

- Counter pressure filler for glass growlers
- No foam
- Less than 2% waste
- Long beer shelf life



## Pegas CraTap

CraTap uses a unique system that allows the user to determine the amount of foam. Therefore, the user can reduce their waste down to 2-0% while utilizing 98-100% of the product in each keg. Pegas CraTap being a manual system uses the same operating principle found in large beer bottling factories around the world; counter-pressure method. This method ensures the bottles are filled in the way that only automatic fillers can provide - without foam and at a rate two liters in just over sixty seconds.

- Fills growlers fast, 2 litres in just over 1 minute
- Eliminates oxygen in the bottle
- Reduces or eliminates
- Less than 2% waste
- Fits several bottle sizes
- Dispenses up to 4 beers



*Pegas CraTap on a Kegbar*



## BREWERY TARGETED PRODUCTS

# PEGAS CRAFTPAD

PEGAS CraftPad is an additional switching manifold to CraTap that allows you to dispense up to 4 different beers from one CraTap unit.



Switch View

## Pegas CraftPad

CraftPad 2.0 is an additional device specifically designed for the PEGAS CraTap filler. The PEGAS CraftPad uses 4 switching valves to move between beers or other foamy beverages and to bottle them. The CraftPas has a 5th switching valve. Beer lines are connected to 4 valves and a CO2 line to the fifth. The 5th line is used to purge the beer line with CO2 to avoid beer mixing while bottling.

- Dispense up to 4 different beer brands
- Beer mixing eliminated
- Connects directly to Pegas CraTap
- Two devices connect to make one unit

The CraftPad installs directly to the CraTap



**NEW  
ARRIVAL**

## BREWERY TARGETED PRODUCTS

# PEGAS CRAFTPAD LIGHT



- Dispense up to 6 beer brands from your CraftTap
- New unique design, more ergonomical
- Whole system is blown through after every pour



## Pegas CraftPad Light

PEGAS CraftPad Light is the new and advanced multi-dispense system for the PEGAS Crafttap. The PEGAS CraftPad light is created to dispense up to 6 beer brands and other foaming beverages through 1 device. PEGAS has combined the key strengths of PEGAS CraftPad with modern design.

- Dispense up to 6 different beer brands
- Whole system is blown through after every pour
- Can be built into any horizontal or vertical surface
- Extra space to mark beer brands on CraftPad Light
- 30% lighter than the CraftPad
- CraftPad Light can be installed separately from CraftTap

The CraftPad Light can be installed on any surface



# BREWERY TARGETED PRODUCTS

## GROWLER FILLING STATION

- Growler Filling Stations come in a variety of lengths
- Can be used with growler fillers, towers, etc.
- Great for sampling and pouring



### Growler Filling Station

The Growler Filling Station is a great option for filling growlers and sampling beers or pouring pints. You can customize the station to suit your needs. The stations come in a variety of sizes to make it convenient for your location.

- Units come in 58", 68" or 94" length
- Can be used with a variety of different towers
- Can mount Pegas CraftPad or CraftPad Light
- Can store several different kegs for accomodation



# BREWERY TARGETED PRODUCTS

## GROWLER WASHING STATION

NEW  
ARRIVAL

- Two machines in one - dishwasher and bottle washer
- Hi-temp sanitizing bottle washer rack
- Washes and sanitizes
- Ideal for growler bottles, wine bottles, etc.



### Growler Washing Station

The Growler Washing Station is great for washing and sanitizing all shapes and sizes of bottles; this concept is ideal for Growler Bottles.

The racks are filled with a spray manifold system that places a strategically positioned spray jet inside the neck of each bottle. The washers rack has 9 compartments holding up to 6" diameter bottles. Each rack has a standard 20" x 20" footprint and rack height is determined by the size of the bottle and how many rack extenders are required.

- Great for washing and sanitizing
- Works with all shapes and sizes of bottles
- Racks are fitted with a spray manifold system
- Spray jets fit directly into each bottle
- Standard bottle washer rack has 9 compartments



**NOTE:** Graphics on machine is for show only



# BREWERY TARGETED PRODUCTS

## PEGAS EVOLUTION FAUCET

- Beer Filler for all PET Bottles
- No cartridge required
- Foam free dispensing

### PEGAS Evolution

The PEGAS Evolution Faucet device doesn't have a cartridge. Instead, it is equipped with a switch flow developed by the company and designed as a separate easily-detachable unit. If needed, it can be replaced as easily as a cartridge. It significantly simplifies seasonal maintenance – no need to completely dismantle device. Just disassemble it, thoroughly wash it, lubricate, assemble and keep on working. The whole process won't take longer than 2 minutes.

- Works on any type of PET-bottle
- No cartridge
- Lasts for at least 100,000 cycles



Evolution Faucet with a Dragon Tower on a Kegmaster 2

## BREWERY TARGETED PRODUCTS

# CRAFT BEER DISPENSING STATION

- Distribute cold bottles and draught beer from one compact unit
- Custom branding is available

## Craft Beer Dispensing Station

The Craft Beer Dispensing Station is a two-in-one unit that distributes bottles and draught beer.

- Commercial Grade Refrigerator
- Digital Thermostat
- Energy Efficient
- Forced Air Evaporator
- Stainless Steel Wall Mount Drip Tray
- Custom Branding Available



Stainless Steel Wall Mount Drip Tray

# BREWERY TARGETED PRODUCTS

## CERAMIC TAP HANDLES

Beautiful, highest quality ceramic tap handles. Available in virtually any design to represent your beer in restaurants and bars. All handles are made with the highest quality ceramics, resin and other materials. Our specialized team is happy to work with you on your design and development to completion.



# BREWERY TARGETED PRODUCTS ILLUMINATED PUB SIGNS

- Variety of shapes and sizes
- Innovative eye-catching design
- Custom branding for breweries, bars and restaurants





# BREWERY TARGETED PRODUCTS

## BRANDED JOCKEY BOXES

- Cold keg beer anywhere, anytime without electricity
- Option of custom branding
- Ideal for events, tradeshow, etc.

- Available with 50', 70' or 120' coils
- UBC square coils for a better fit
- Quick disconnects for beer lines
- Optional tower for the top of the Jockey Box

### Branded Jockey Boxes with Coils

Part No.	Faucets	Finishing	Coil Length	Coil O.D.
JB70SS-1	1	Stainless Steel	70'	5/16"
JB120SS-1	1	Stainless Steel	120'	3/8" - 1/4"
JB70SS-2	2	Stainless Steel	2 x 70'	5/16"
JB120SS-2	2	Stainless Steel	2 x 120'	3/8" - 1/4"
JB50SS-3	3	Stainless Steel	3 x 50'	5/16"
JB50SS-4	4	Stainless Steel	4 x 50'	5/16"

Contact us for a free mock up with your design



## BREWERY TARGETED PRODUCTS

# PATIO UMBRELLAS, CHALKBOARDS

- High wind speed rating
- Ideal for multi-season use
- Fade resistant printing materials
- Available in several shapes and sizes



## BREWERY TARGETED PRODUCTS

# TABLES

- Designed for patios, special events and large venues
- Steel frame construction allows for multi season use
- Branding is easily customizable and tables/chairs available in several different models



P2.001



P2.011



TOLL FREE: 1 (866) 995-9965, [www.beer-co.ca](http://www.beer-co.ca)



P2.001

M096

## Warranty Terms

UBC Group warrants that its products will be free from defects in material and workmanship, under normal use, regular service and preventative maintenance for 1 (one) year as described in the warranty. The warranty period for compressors is 5 (five) years as described below.

### PREREQUISITES

This warranty is available to the first end user for equipment purchased from UBC's authorized dealers. Equipment resold without such authorization will not be covered under this warranty.

All equipment must be properly installed according to guidelines found in the product manuals.

Approved usage conditions for operation must be provided as required in the product manuals (including but not limited to ambient conditions, dedicated power circuit and required clearance)

All equipment must be maintained and cleaned regularly as specified in the product manual.

In case of equipment failure customer must contact UBC Group for repair authorization number before any repairs are made.

Warranty claim form must be completed in full and submitted to UBC Group at the time of purchase.

### WARRANTY PERIOD

Warranty period is one (1) year from the date of installation but no longer than eighteen (18) months from date of sale. Compressor warranty period is five (5) years from the date of installation or sixty eight (68) months from the date of sale from UBC Group.

A warranty stub or documents of sale from distributor must be submitted for units not sold directly by UBC for warranty to be valid.

### WARRANTY COVERAGE

Refrigeration Units (including compressor)

If a product is deemed defective by UBC group within the warranty period described above, UBC Group, at its discretion, will either repair or authorize the repair of the product. UBC Group will be responsible for the labor charges according to the Labor Charges segment within the warranty period provided that all above mentioned prerequisites are satisfied. UBC Group may also replace the product at its discretion bearing the labor costs for the product replacement according to the Labor Charges segment. The customer is responsible for the return of the defective part or product to UBC Group for inspection and defect determination. Customer must package the part or product according to the instructions provided by UBC Group before shipping it. UBC Group will

cover the shipping costs for the part or product as described in the Shipping segment of this warranty.

### COMPRESSOR

Compressors are covered for an additional Parts Only warranty for a period of four (4) years beyond the general coverage described above. Under the additional coverage if a compressor is deemed defective by UBC Group, providing that all of the prerequisites described above are met, it will be exchanged for a new compressor. UBC Group will not cover the labor charges associated with the compressor replacement. It is the responsibility of the customer to return the defective part to UBC Group. The customer must return all parts of compressor and package the part according to the instructions provided by UBC Group before shipping it. UBC Group will cover the shipping costs for the part as described in the Shipping segment of this warranty.

The customer has the option to send the unit to UBC Group for compressor replacement and in this case will be responsible for all shipping charges. There will be no additional charges by UBC Group for the compressor replacement.

### DEFECT DETERMINATION

UBC Group is the only body authorized to determine defects. Customers must contact UBC Group to receive authorization for any course of action prior to any repairs. A warranty claim form must be completed and submitted to UBC Group in order to process the claim and authorize any reimbursements. If a repair is made without an authorization number from UBC Group it will not be covered by the warranty and will not be reimbursed.

If a part or product is authorized for return it is for inspection purposes only. It is the sole discretion of UBC Group as to whether or not a credit/refund will be allowed.

UBC Group's determination of defects is final.

### PRODUCT DELIVERY

The customer is responsible for inspecting units upon receipt for concealed damage caused during shipping. The customer must report damaged/non-working units or components to UBC Group immediately. Deliveries with physical damage should be denied. A claim must be filed with the carrier for any damages that occur during shipping. UBC Group is not responsible for units damaged during shipping.

## WARRANTY DOES NOT COVER

- Physical damage or water damage to the unit caused by negligence of the user.
- Improper installation and modifications made without UBC Group's explicit approval.
- Damage resulting from electrical supply, water supply, drainage, flood, storm or any other incidents.
- Repairs made without the explicit authorization of UBC Group or without the submission of the warranty claim form.

### Note:

UBC GROUP IS NOT RESPONSIBLE FOR ECONOMIC LOSS OR SPECIAL, INDIRECT, OR CONSEQUENTIAL DAMAGES, INCLUDING, WITHOUT LIMITATION, LOSSES OR DAMAGES ARISING FROM FOOD OR PRODUCT SPOILAGE CLAIMS AS A RESULT OF REFRIGERATION FAILURE.

## SHIPPING

During the warranty period UBC Group will be responsible for shipping charges as describe in the previous segments. UBC Group will ship replacement parts using standard ground shipping only. Refrigeration units will be shipped on pallets ground freight (LTL) only. If expedited shipping is needed the customer will incur the difference in shipping cost.

## Return Policy

UBC Group will accept returns for items within 30 days from the date of delivery. Returned items must be unused, in original condition and packaging, and must include all documentation and accessories. Special orders, custom orders are subject to 25% restocking fee. Closeout items cannot be returned.

A return authorization must be obtained from UBC Group for any merchandise return. Packages without a return authorization number on them will not be accepted. "Authorization for return" is for inspection purposes only. It is the sole discretion of UBC Group as to whether or not credit/refund will be allowed. A minimum 15% restocking fee will be applied to all authorized returns.

The customer is responsible for all shipping charges. Authorized returns must be sent prepaid shipping only. Collect and COD shipments will be refused.

## SHIPPING

Most orders are shipped within 1 to 2 business days via a preferred shipping company. All goods are shipped from our central warehouse at 1143 Haultain Court, Mississauga, Ontario. Shipments are FOB Origin with freight charges prepaid and billed. The shipping charges will be added to the invoice. Some heavy or large items must be shipped LTL Freight. Freight carrier delivery is to back of truck and does not include carrying the item into the building, unpacking or lift gate service to unload the shipment. If a dock or forklift is not available, lift gate service is available for an additional charge. Deliveries are made Monday thru Friday, excluding holidays.

## RECEIVING MERCHANDISE: FREIGHT CARRIER

Upon delivery, carefully inspect the contents of the shipment for any indication of damage before signing the carrier's bill of lading. The driver is required to be present during the inspection. If damage is found, the shipment should be refused and the carrier is required to take the shipment back. If the outside packaging is damaged but the contents are not, you should accept the shipment and make a note on the freight bill that the outside packaging was damaged. This will protect your rights in the event of a concealed damage claim.

By signing the carrier's freight bill without any notations of damage, you are agreeing that the shipment was delivered in good condition. Any damage found after that point, should be directed to the freight carrier in the form of a concealed damage claim. UBC Group is not responsible for freight damage claims once the shipment was signed for as received in good condition. UBC Group's responsibility ceases upon the shipments acceptance by the recipient.

## RECEIVING MERCHANDISE: PARCEL SERVICE

Inspect the shipment upon delivery before accepting it. If your shipment has arrived damaged, incomplete or otherwise tampered with, notify your delivery person immediately. Customers are responsible for checking their order when it arrives to ensure that all items are present. If shipment has arrived complete and undamaged but there are discrepancies, please notify us immediately (within five business days). UBC Group is not responsible for missing or damaged items unless notified by the customer within the allowed period.

## Index

Air Distributors	70	Wall Brackets	83
Arcadia	16	90 Tail Pieces	83
Back Bar Coolers		Gear Clamps	83
CoolBar BB-100	97	Crosses	83
Large Back Bar Coolers	98	U-Bends	83
Bottle Water Dispensers	61	Hose Plugs	83
Carbonator Coolers	59	Coil Fittings	83
Carbonators	60	Flash Coolers	55
Ceramic Towers	39	FOBS	
Chalkboards	122	FOB Controllers	78
CO2 Tanks	101	Fittings	78
Coils	101	Gas Blenders	73
Cold Plates		Gefest Tower	11
Cold Plates	61, 101	Glycol	105
Cold Plate Fittings	101	Glycol Power Packs	52
Connectors	61	Gothic Towers	28
Cylinder Towers		Growler Fillers, PEGAS	
Cylinder Towers	31	CrafTap	112
Cylinder Towers Branded	110	CraftPad	113
Double Pedestal Towers	33	CraftPad Light	114
Drip Trays		Filling Station	115
Countertop	46	Washing Station	116
Platform	47	Evolution Faucet	117
Wall Mount	48	ICE Towers	
Parts	48	TOF Towers	36
Clamp On	49	Arcadia Towers	36
Faucets		Cobra Towers	37
Domestic Faucets	43	Illuminated Signs	120
Stout Faucets	43	Indie	13
Stout Faucet Parts	43	In-line Leak Detectors	73
Euro Flow Control	44	In-Line Regulators	60
Accessories	44	JG Towers	22
Fittings		Jockey Boxes	
Elbow Splicers	82	With coils	102
Y-Fittings	82	With Towers	103
Stepless Clamps	82	With Branding	121
Splicers & Reducers	82	Tapping Kits	103
T-Fittings	82	DIY Kits	103
Tail Pieces	82	John Guest Fittings	
Cold Plate Fittings	83	Superseals	79
		Reducers	79
		Shut-offs	79
		CPC Fittings	80
		BSPP	70

## Index

---

Bulkheads	80	Pumps & Motors	
Locking Clips	80	Rotary Vane Pumps & Motors	74
Tees	80	Pump Parts	74
Stems	81	Vertical Agitator Pump	74
Dividers	81	Beer Pump	74
Connectors	81	Refrigerators	
Keg Couplers		IceStream Smart Cool	93
TapRite	75	IceStream Optima	94
Economy	75	IceStream Super Large	95
MicroMatic	76	Craft Beer Dispensing Station	118
Accessories	76	Regulator Assemblies	72
Parts	77	Regulator Panels	71
Kegeators		Regulators	
Large Kegeators	88	Primary CO2 Regulators	67
Kegbar	89	Primary Nitrogen Regulators	67
Kegmaster	90	Secondary Regulators	68
Accessories	91	Regulator Parts	69
Kegs		Shanks	
Kegs	65, 111	Shanks	41
Keg Caps	66	Shank Parts	42
Keg Accessories	66	SUN Tower	11
Keg Spears & Parts	66	Tables	123
Large Diameter Towers		Tap Handles	119
4" Bridge	23	Tape	85
4" Arch	23	Tee Box Towers	32
4" Pass Thru	23	Terra Towers	19
Line Cleaning		Thermostats	105
Cleaning Kits	106	Trunkline	84
Accessories	106	Tubing	
Cleaning Valves	107	Insulation Tubes	85
Cleaning Cans	107	Thermoplastic Vinyl Hose	86
Cleaning Caps	108	Braided Vinyl Hose	86
Line Cleaners	108	Polyethylene Hose	86
Milano Towers	27	Accessories	85
Party Pumps	101	Umbrellas, Patios	122
Persey Tower	14	Under Bar Dispenser Towers	34
Ponte Towers	29	Venus Towers	28
Pumps		Vice Tower	12
FloJet Pumps	60	Wall Mount Dispenser Towers	34
Pump Fittings	60	Water Filtration	61
		Wine-on-tap Coolers	63
		Wrenches	105
		Xenia	26
		Yukon Towers	24



UBC COOL Canada Inc  
1143 Haultain Court,  
Mississauga, ON, L4W 2K1

Phone: 905 629-2597  
Toll Free: 866 995-9965  
Fax: 905 629-2577  
Email: info@beer-co.ca

[WWW.BEER-CO.CA](http://WWW.BEER-CO.CA)

